

## FP-4-150-SM/SP

### Highlights

- Conduction cooled
- Polypropylene dielectric
- Self-healing
- Operating frequency up to 700 KHz
- Maximum operating core temperature 85°C
- Capacitance tolerance  $\pm 10\%$
- Flame retardant UL94 - V0, ROHS compliant



### Standard Capacitor Values

Rated Voltage Vrms	Nominal Capacitance MFD at 1KHz	Max Current Irms	Max Power Kvar	Frequency KHz	ESR mΩ	Dimensions mm			Case Code	Terminal Style	Ordering Code
						B	H	L			
1000	0.05	200	150	478-700	1.5	30.2	30	68	D1	SM/SP	SP00U051000AS0D1___K01
	0.10	250	150	238-423	1.5	30.2	30	68	D1	SM/SP	SP00U11000AS0D1___K01
700	0.17	250	150	286-389	1.2	30.2	30	68	D1	SM/SP	SP00U170700AS0D1___K01
	0.25	250	150	195-265	1.2	30.2	30	68	D1	SM/SP	SP00U250700AS0D1___K01
	0.33	250	150	148-200	1.0	30.2	30	68	D1	SM/SP	SP00U330700AS0D1___K01
	0.50	250	150	93-132	1.0	30.2	30	68	D1	SM/SP	SP00U50700AS0D1___K01
600	0.66	300	150	100-145	0.8	30.2	30	68	D1	SM/SP	SP00U660600AS0D1___K01
500	1.20	300	150	79-80	0.6	30.2	30	68	D1	SM/SP	SP001U20500AS0D1___K01
	1.33	300	150	72	0.6	30.2	30	68	D1	SM/SP	SP01U330500AS0D1___K01
400	2.40	400	150	63-72	0.6	30.2	30	68	D1	SM/SP	SP002U40400AS0D1___K01

### Capacitor Drawing and Terminal Style

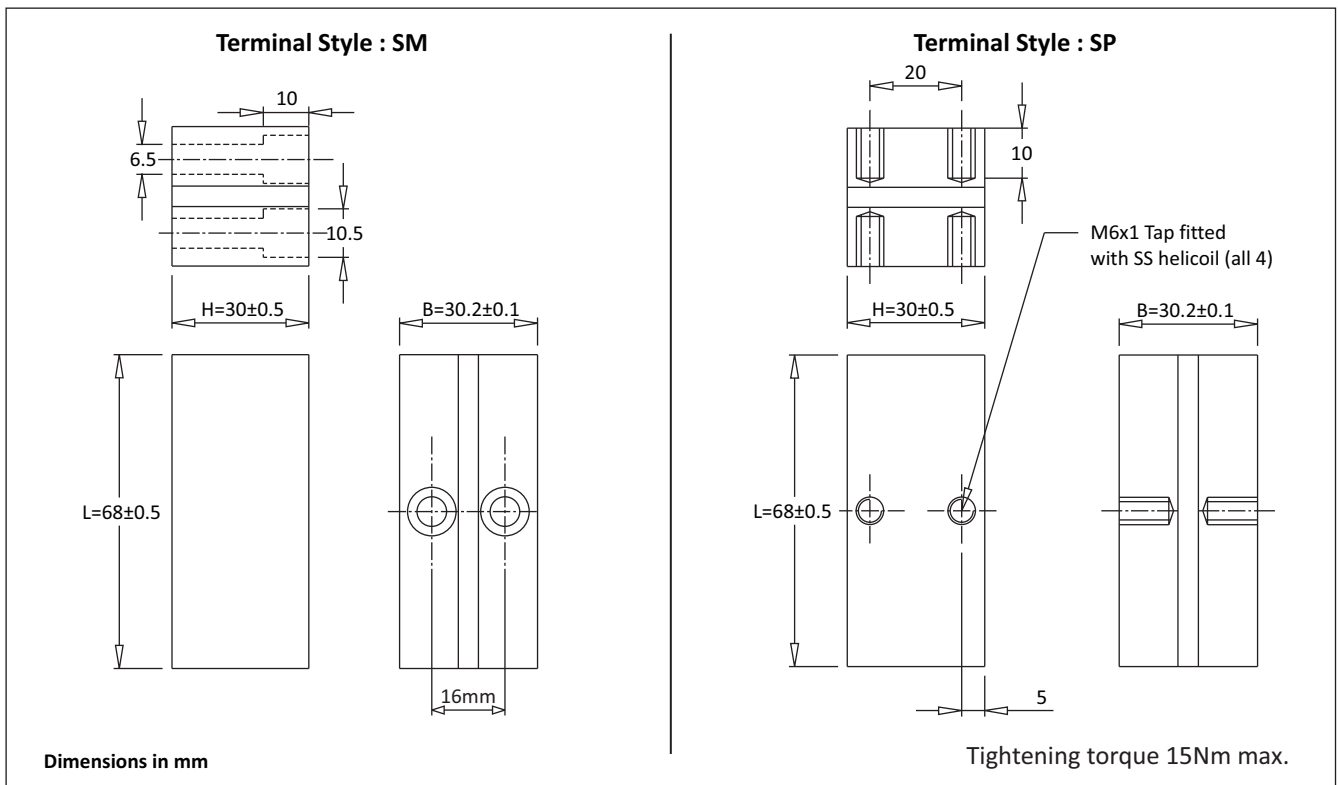

## FP-4-150-SM/SP

### Frequency Derating

—◆— Voltage    —■— Current    —▲— Power

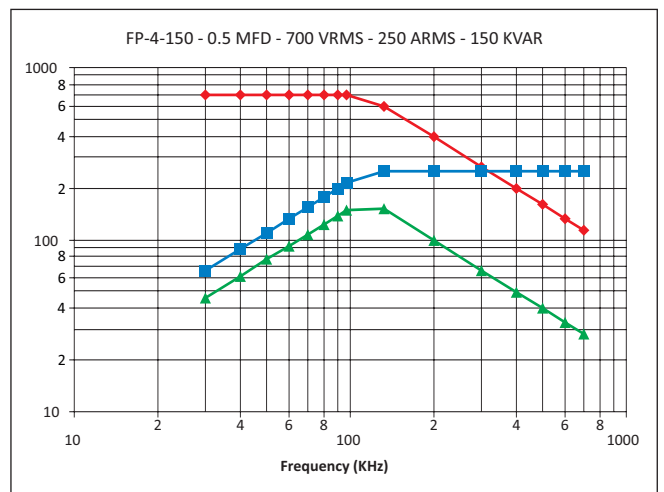
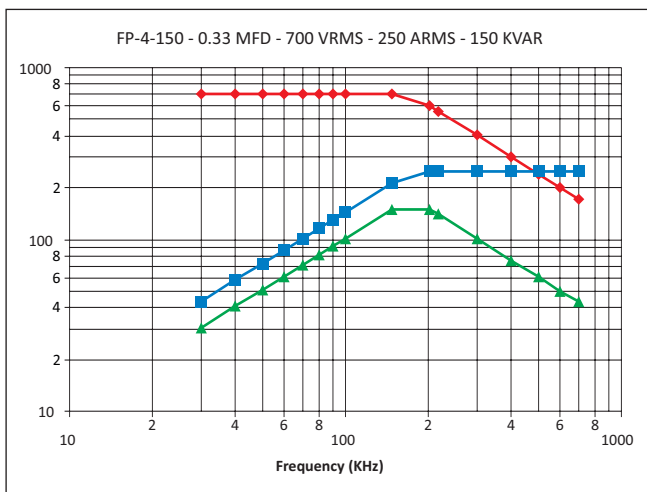
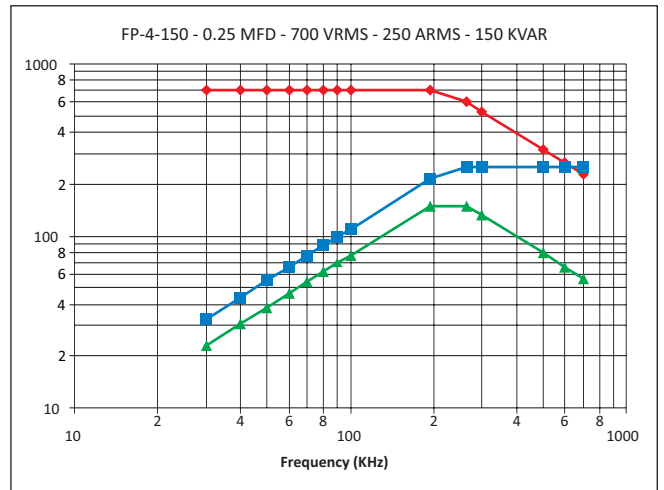
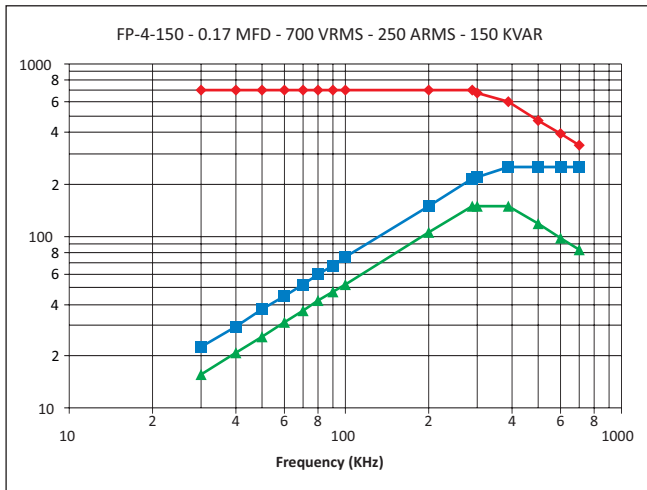
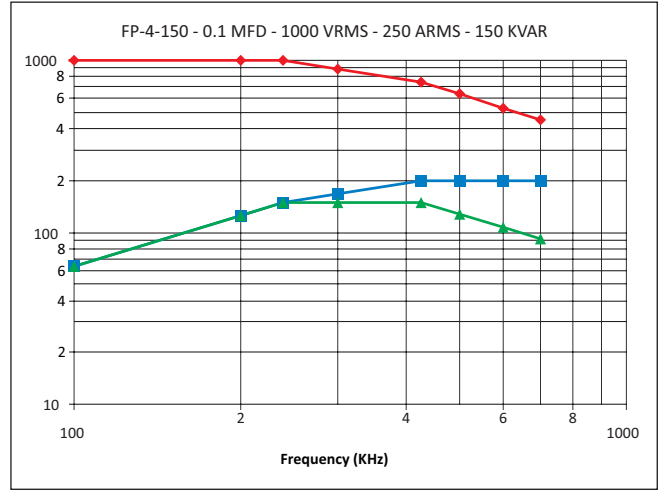
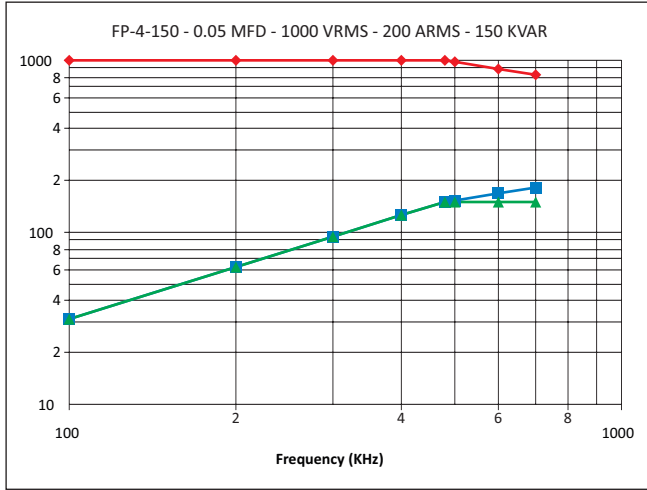

## FP-4-150-SM/SP

### Frequency Derating

—◆— Voltage    —■— Current    —▲— Power

