

## FP-9-300

### Highlights

- Conduction cooled
- Polypropylene dielectric
- Self-healing
- Operating frequency up to 700 KHz
- Maximum operating core temperature 85°C
- Capacitance tolerance  $\pm 10\%$
- Flame retardant UL94 - V0, ROHS compliant

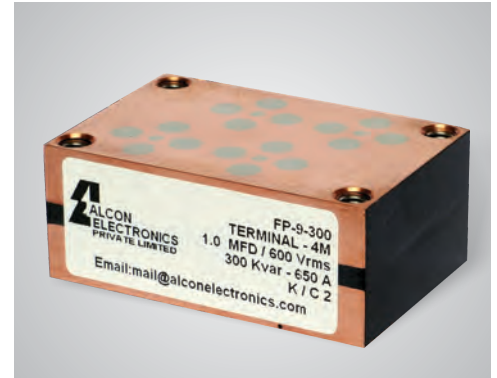

### Standard Capacitor Values

Rated Voltage Vrms	Nominal Capacitance MFD at 1KHz	Max Current Irms	Max Power Kvar	Frequency KHz	ESR mΩ	Dimensions mm			Case Code	Terminal Style	Ordering Code
						B	H	L			
1000	0.10	350	300	476-649	1.2	30.2	50	75	F1	4M	SP000U11000A10F1004MK01
	0.20	500	300	238-423	1.2	30.2	50	75	F1	4M	SP000U21000A10F1004MK01
700	0.33	500	300	295-401	1.0	30.2	50	75	F1	4M	SP00U330700A10F1004MK01
	0.66	500	300	147-200	0.8	30.2	50	75	F1	4M	SP00U660700A10F1004MK01
600	1.00	650	300	132-223	0.5	30.2	50	75	F1	4M	SP000010600A10F1004MK01
	1.32	650	300	100-170	0.3	30.2	50	75	F1	4M	SP01U320600A10F1004MK01
500	2.60	650	300	72-85	0.2	30.2	50	75	F1	4M	SP002U60500A10F1004MK01
400	5.00	800	300	59-67	0.1	30.2	50	75	F1	4M	SP000050400A10F1004MK01

### Capacitor Drawing and Terminal Style

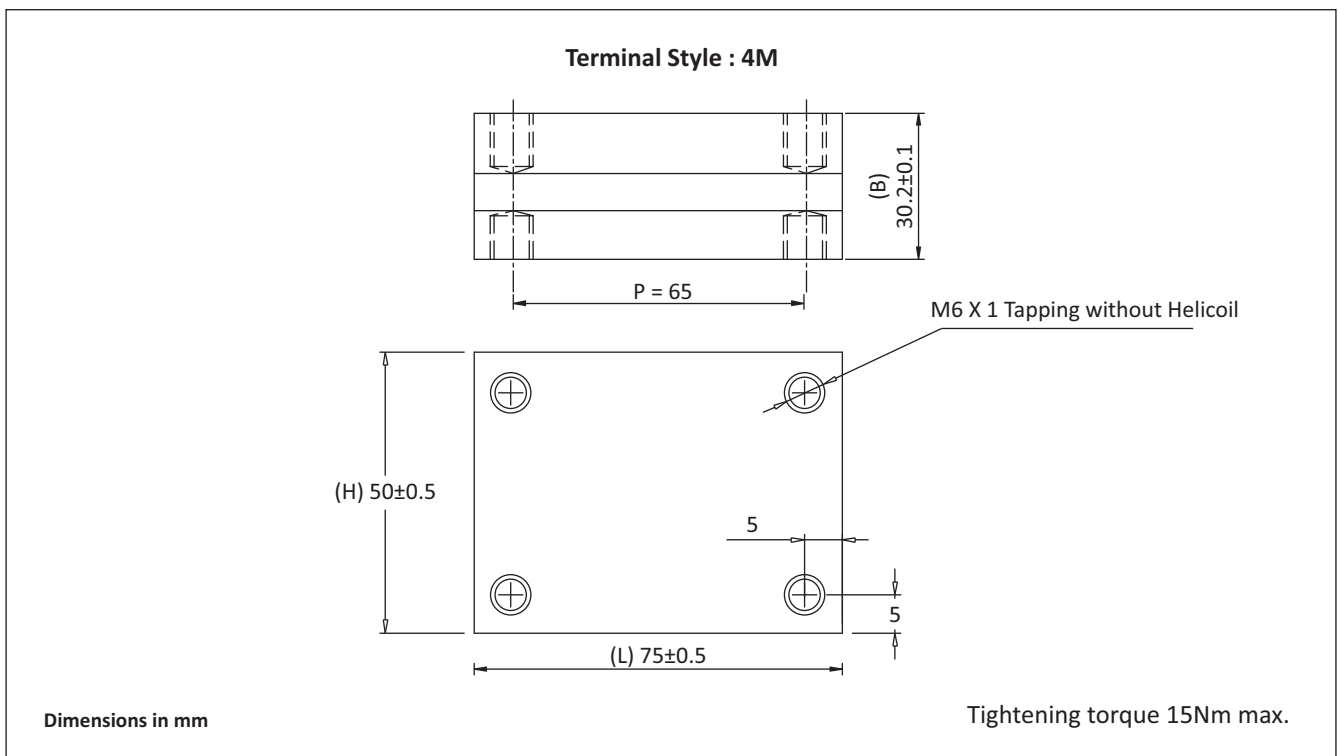

## FP-9-300

### Frequency Derating

—◆— Voltage    —■— Current    —▲— Power

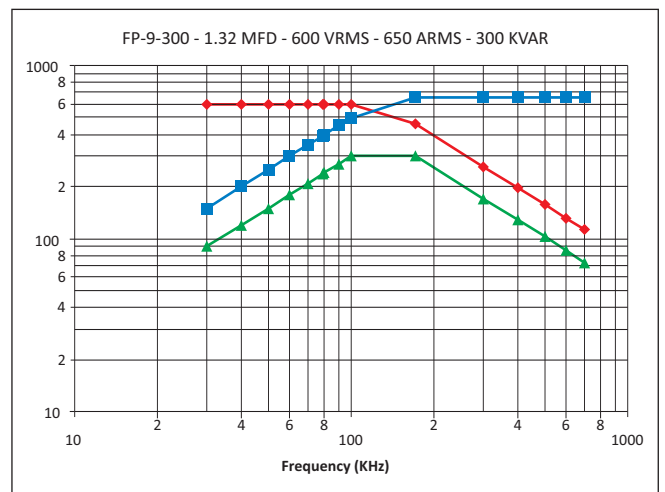
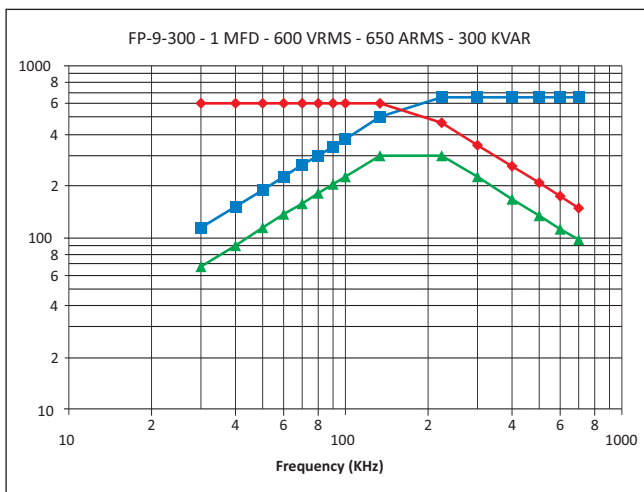
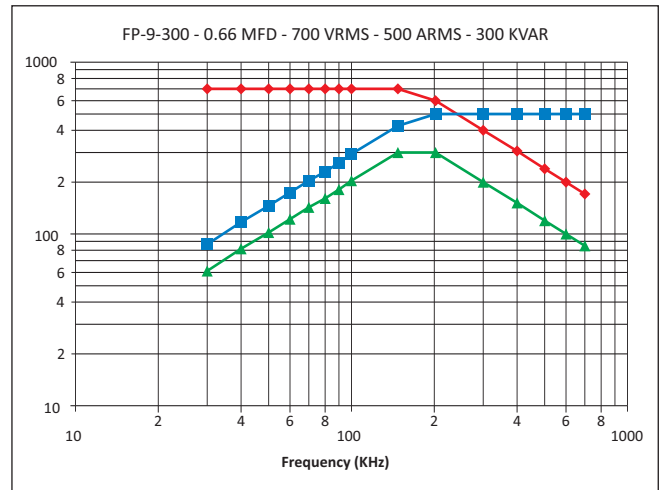
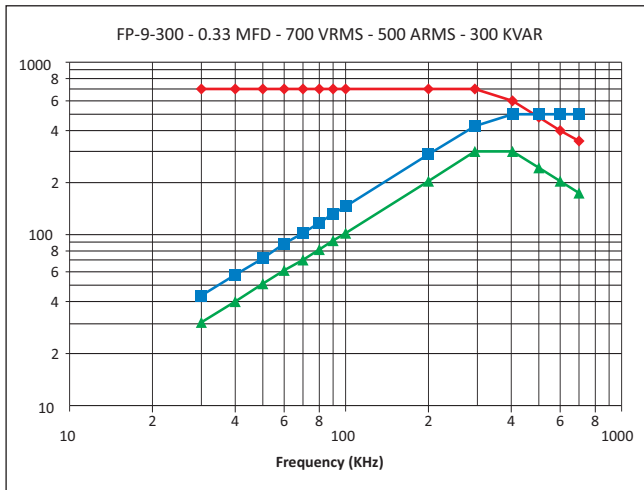
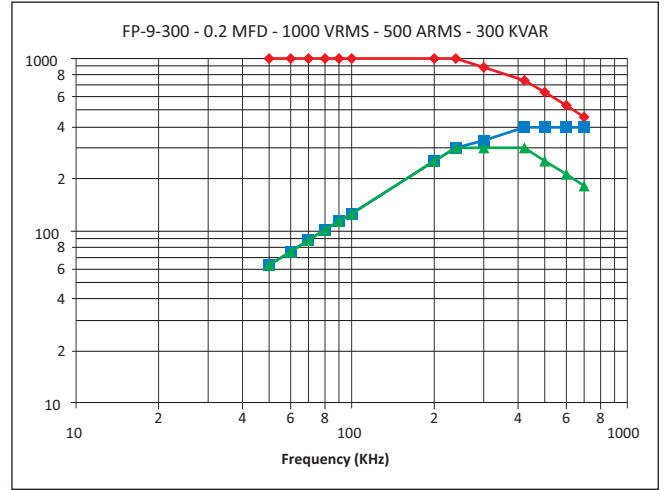
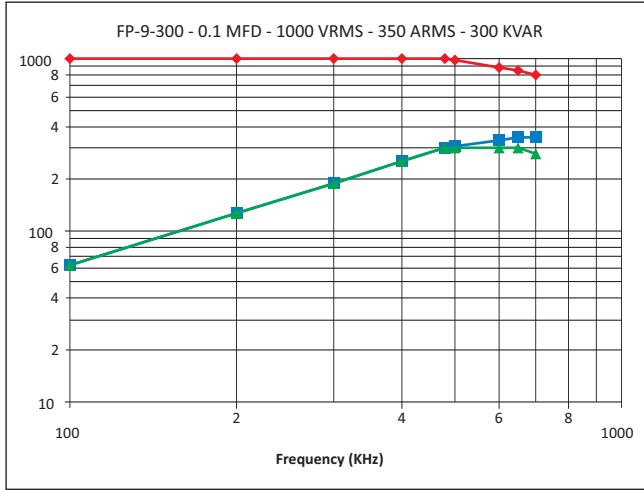

## FP-9-300

### Frequency Derating

—●— Voltage    —■— Current    —▲— Power

