

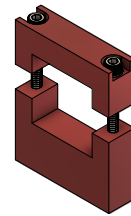

REVISION HISTORY

REV	DESCRIPTION	DATE	APPROVED
A	INITIAL RELEASE	7/28/2022	DA

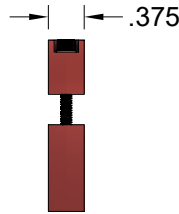
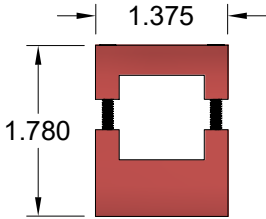
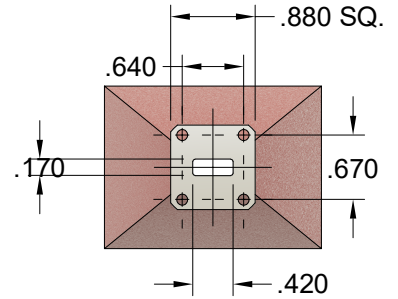
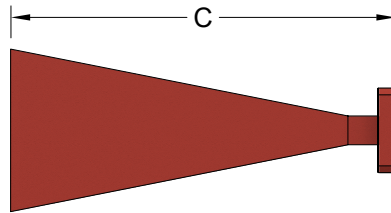
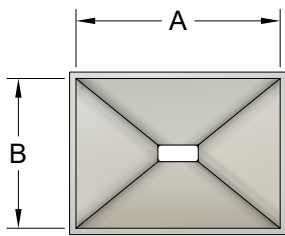
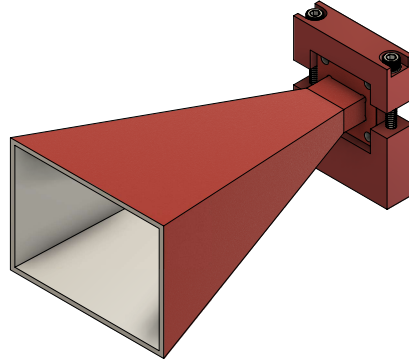

1/4-20 UNC - 2B  
 √0.300

WR42 20dB GAIN HORN ANTENNA							
WG SIZE	FREQ. (GHz)	GAIN (dB)	3dB Beam Width (E-Plane)	3dB Beam Width (H-Plane)	Dim. A (in)	Dim. B (in)	Dim. C (in)
WR42	18-26.5	20	17.5°	17.8°	2.13	1.56	4.00

THIRD ANGLE PROJECTION:  UNLESS OTHERWISE NOTED, DIMENSIONS ARE IN INCHES, TOLERANCES ARE: FRACTIONS: ±1/64 ANGLES: ±1/2° MACHINED FINISH: 63 OR BETTER	APPROVALS	DATE	 DRAWING WR42 20DB HORN ANTENNA, OUTLINE			
	DRAWN Dirk Aubram	7/28/22				
	CHCKD.		SIZE	CAGE CODE	IT#	DRAWING#
	APRVD.		6CDA9			OTL42-20-ITI
DECIMALS 2 PLACE      3 PLACE	MATERIAL ALUMINUM	TREATMENT CHEMFILM	SCALE 1:2	MODEL#	SGH42-20-ITI	REVISION A SHEET 1/1
±.03      ±.005	FINISH RED					