

REVISION HISTORY

REV	DESCRIPTION	DATE	APPROVED
A	INITIAL RELEASE	7/29/2022	DA

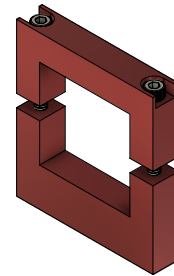
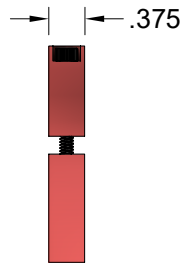
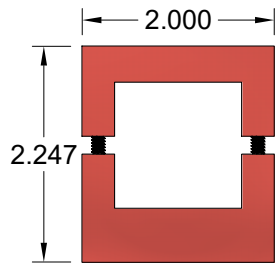
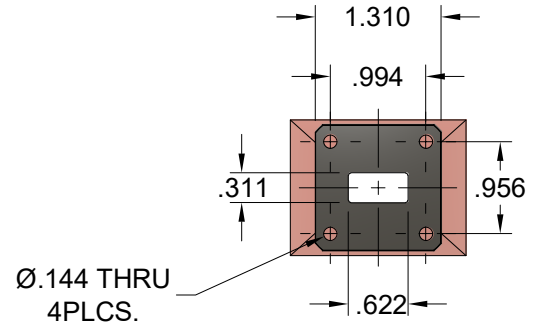
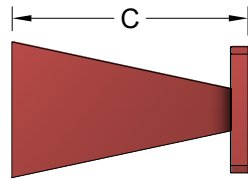
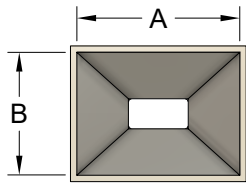
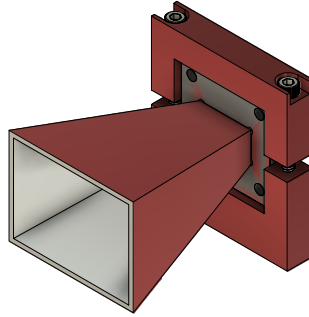

1/4-20 UNC - 2B
 ∇ 0.375

WR62 15dB GAIN HORN ANTENNA							
WG SIZE	FREQ. (GHz)	GAIN (dB)	3dB Beam Width (E-Plane)	3dB Beam Width (H-Plane)	Dim. A (in)	Dim. B (in)	Dim. C (in)
WR62	12.4-18	15	30.1	31.2	1.69	1.3	2.46

THIRD ANGLE PROJECTION:	
UNLESS OTHERWISE NOTED, DIMENSIONS ARE IN INCHES, TOLERANCES ARE: FRACTIONS: ±1/64 ANGLES: ±1/2° MACHINED FINISH: 63 OR BETTER	
DECIMALS 2 PLACE	3 PLACE
±.03	±.005

APPROVALS	DATE
DRAWN Dirk Aubram	7/29/22
CHCKD.	
APRVD.	
MATERIAL ALUMINUM	
TREATMENT CHEMFILM	
FINISH RED	

DRAWING WR62 15dB HORN ANTENNA			
SIZE	CAGE CODE	ITTT DRAWING#	REVISION
	6CDA9	OTL62-15-ITI	A
SCALE	MODEL#		SHEET
1:2	SGH62-15-ITI		1/1