

SPINNER Broadcast

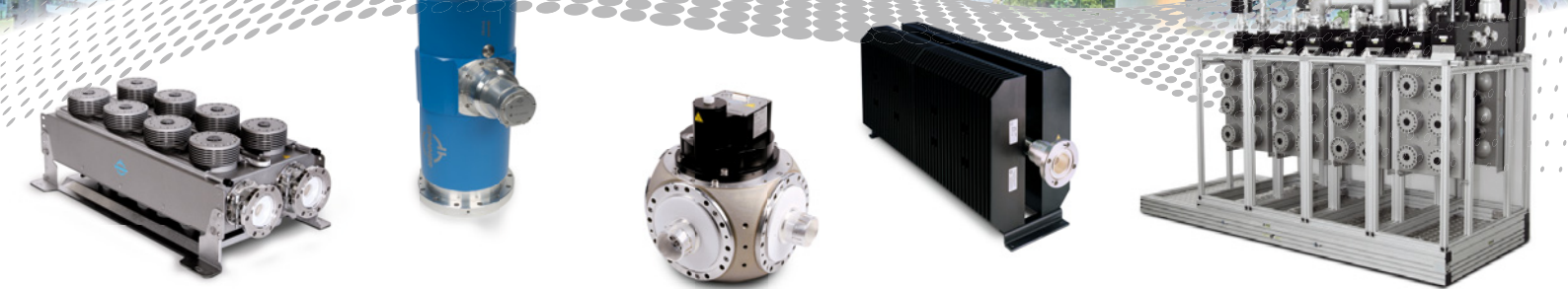

Smart RF Solutions for Efficient Broadcast Networks

Edition L/2021

HIGH FREQUENCY PERFORMANCE WORLDWIDE
www.spinner-group.com





For more information on products, please use our Product Finder at products.spinner-group.com



You can get the latest new edition of our broadcast catalogue in the download section of our website. Please follow this link: www.spinner-group.com/downloads

The specifications given here as well as the illustrations are for information. They shall only be confirmed by SPINNER's written offer and are subject to technical amendments.

© 2021 SPINNER



Contents

AMS Antenna Monitoring System	4
Multi-Channel Combiners	15
Bandpass Filters.....	101
Patch Panels	136
Parallel Switching Units.....	147
Two-Way Coaxial Switches	151
Rigid Lines and Cable Connectors.....	174
Adapters & Measurement Accessories	207
Loads.....	220
Environmental Conditions for Broadcast Products.....	231

Antenna
Monitoring System

Multi-Channel
Combiners

Bandpass
Filters

Patch
Panels

Parallel
Switching Units

Coaxial
Switches

Rigid Lines & Cable
Connectors

Adapters & Measurement
Accessories

Loads

AMS Antenna Monitoring System

Distance to Fault Detection



The SPINNER Antenna Monitoring System (AMS) protects broadcasting infrastructure by continuous monitoring the entire antenna system and detecting faults at an early stage, such as arcing or water ingress. It informs you about them as well as their location in order to prevent a severe failure.

Radio and television broadcasters worldwide rely on their systems to deliver content to listeners and viewers. Although their infrastructure may be robust, it can still be vulnerable.

Arcing or water ingress can occur for various reasons such as damaged components by bad weather or long-term use, improper installation, RF overloads, or even unexpected events.

The heat generated by the arc can damage the infrastructure or even lead to fire, thus completely disabling the broadcast system. The resulting long off-air times and financial losses incurred by repairs and legal claims are often substantial.

Operators therefore need a reliable early failure detection system to prevent serious damage. The SPINNER Antenna Monitoring System can help with this.

AMS Antenna Monitoring System

The AMS uses two different measurement methods to reliably detect any type of arc, even ones that won't cause VSWR degradation. It also informs you where the problem is so it can be quickly repaired, thus saving you both time and money.

If a fault is detected, you are informed not only locally by LED lamps, but also remotely via SNMP and a user-friendly web interface. Optionally, you can also connect the AMS to the interlock loop of your transmitter, switching it off in the event of an alarm to protect the infrastructure.

Optionally, a power monitoring add-on is also available. It monitors the power level and return losses on up to four RF channels (eight RF probes). Different thresholds for warnings and alarms can be individually set. All of the information is displayed on the web interface and also sent via SNMP. An interlock interface is also available.

It has an ingeniously simple design, with easy and fast installation. All the components are housed indoors. There are no invasive changes to the system and no signals are injected into your antenna.

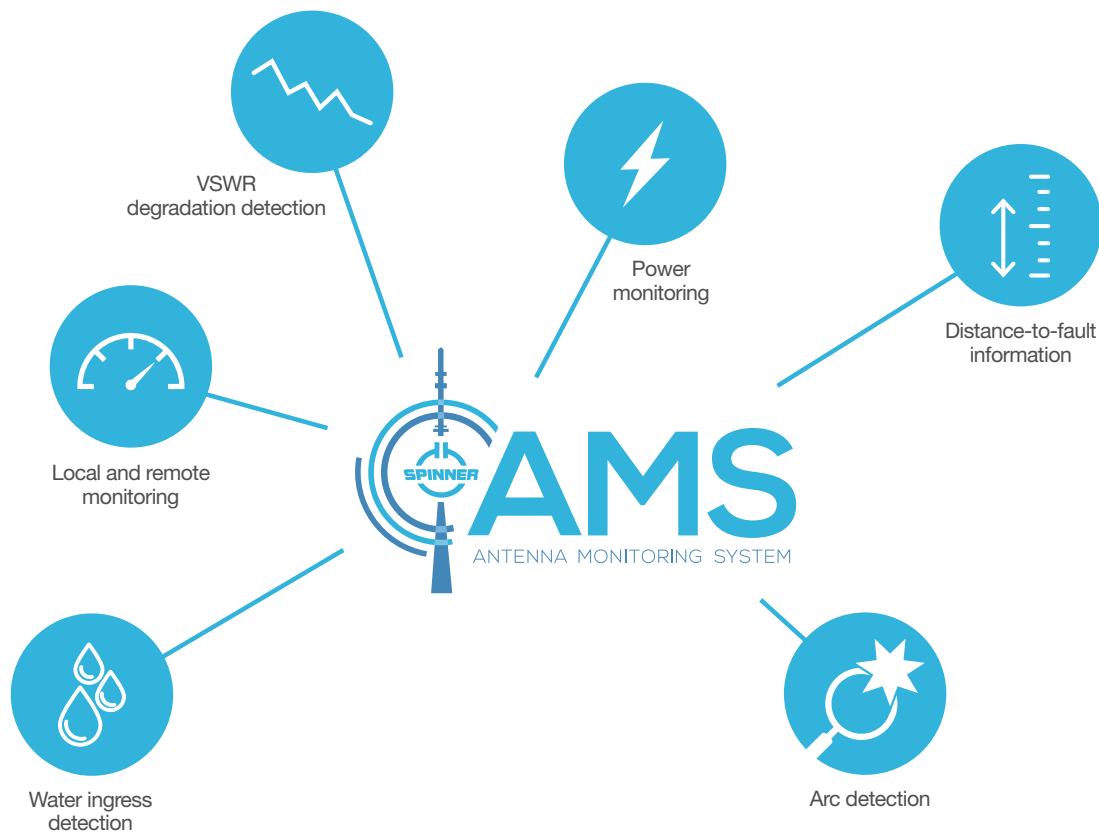

Features & Benefits:

- ✓ Fault detection, as arcing and water ingress
- ✓ Distance -to-fault information
- ✓ Optional power monitoring add-on
- ✓ Remote monitoring via SNMP and web interface
- ✓ Local signaling via LEDs and status relays
- ✓ Protection by integration in interlock loop
- ✓ Detection in antennas up to 750m / 2460 feet
- ✓ Compact design
- ✓ Fast and easy installation
- ✓ All components indoors
- ✓ No signal injected into antenna line
- ✓ Suitable for pressurized lines
- ✓ 4 digital inputs for any use, e.g. pressure sensors

AMS Antenna Monitoring System

Schematic

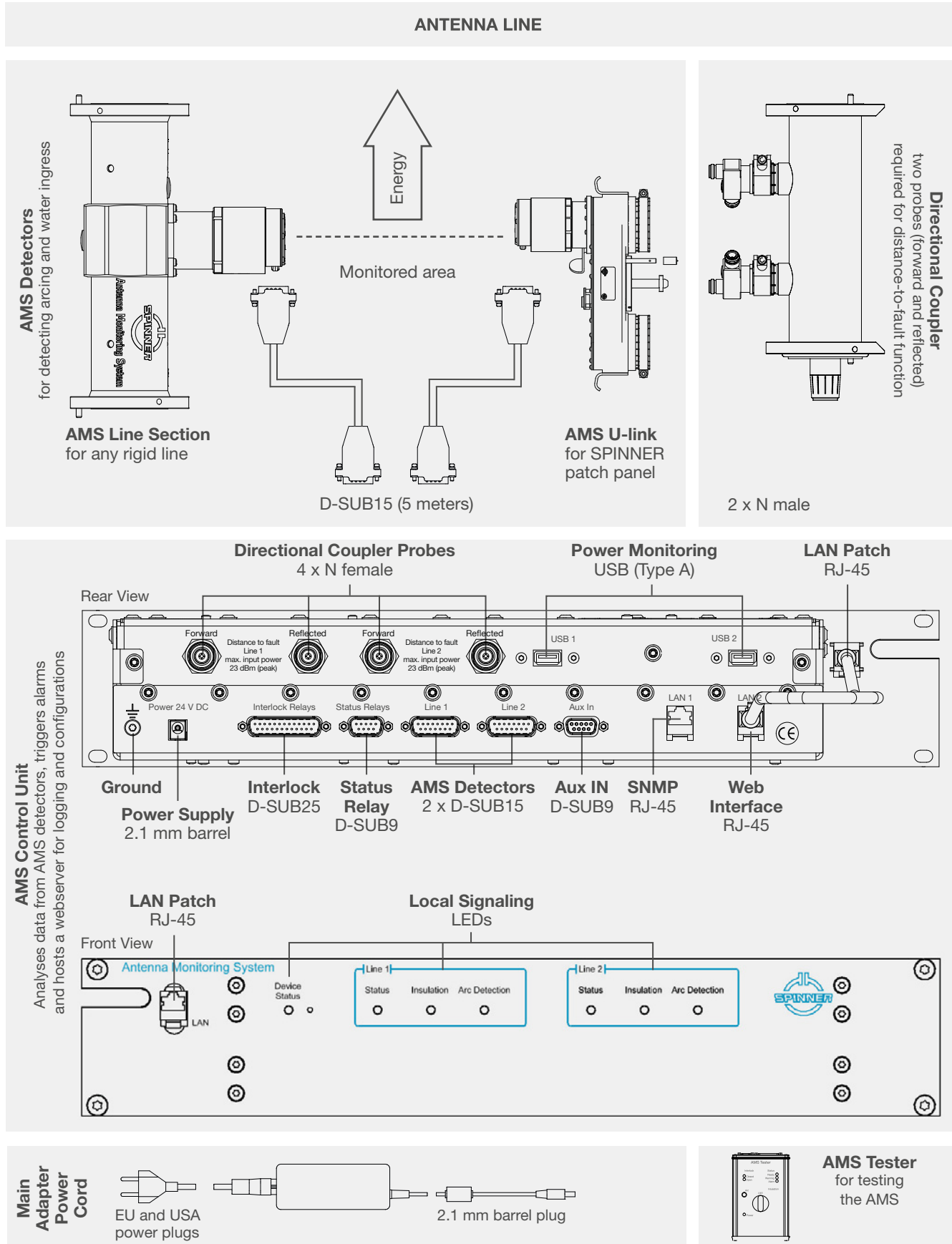

AMS Antenna Monitoring System

AMS Control Unit

Collects and analyzes data from AMS detectors and directional couplers. When thresholds are exceeded, it triggers warnings and alarms via relay contacts and SNMP. It also hosts a web server for convenient configuration of the AMS system.



General Data

Broadcast standards	FM, DAB, ATSC 1.0, ATSC 3.0, DVB-T/T2, ISDB-Tb
Arc detection, min.	100 μ s
Distance-to-fault accuracy	\pm 2 meters
Emission	No signal injected into antenna line
Size of non-volatile memory, min.	250,000 entries for resistance values, warnings, alarms (10 years of logging with one record per hour)

Mechanical Data

Material and surface	Aluminum alloy
Dimensions (L x W x H) mm	158 x 483 x 88 mm (19", 2RU)
Weight	2.5 kg
IP protection level	IP40 per EN 60529
MTBF	220,000 h (40 °C ambient temperature)

Electrical Data

Main adapter interface	Power cords for USA, EU and UK (available on request)
Main adapter voltage	80 VAC to 264 VAC, 47 to 63 Hz, 113 VDC to 370 VDC
Power consumption, max	40 W

Interfaces

AMS detectors	2 x D-SUB 15
Interlock	D-SUB 25 plug 10 potential-free relay contacts, open active, max. 42.4 V ACpk / 60 V DC, 0.5 A, SELV
Relay status	D-SUB 9 plug 3 potential-free relay contacts, open active, max. 42.4 V ACpk / 60 V DC, 0.5 A, SELV
Auxiliary inputs	D-SUB 9 socket 4 digital inputs, electrically isolated, potential-free 8 V DC to 28 V DC, any polarity, high active
SNMP (LAN1)	RJ-45 (LAN1 or LAN2 can be patched to front panel) SNMPv2c, based on IRT recommendations
Web interface (LAN2)	RJ-45 (LAN1 or LAN2 can be patched to front panel) IE 9 or higher, Firefox
Local signalization	LEDs on front panel and AMS detectors
Directional coupler probes for distance-to-fault function	4 x N female (50 Ohms)
Power monitoring add-on	USB (type A)

AMS Antenna Monitoring System

AMS Line Section

AMS detector for mounting in any rigid line run



General Information

Material and surface	Aluminum alloy, painted
IP protection level	IP 50 per EN 60529
Interface	D-SUB 15 socket

Band II

Size	1 5/8" EIA	3 1/8" EIA	4 1/2" EIA	6 1/8" EIA	7 3/16" ¹	8 3/16" ¹	9 3/16" ¹
Impedance	50 Ω	50 Ω	50 Ω	50 Ω	75 Ω	75 Ω	50 Ω
Proof voltage	7 kV	16 kV	18 kV	22 kV	22 kV	24 kV	24 kV
Avg. power (at 108 MHz)	20 kW	67 kW	127 kW	140 kW	202 kW	256 kW	360 kW
VSWR	1.06						
Dimension (LxWxH) mm	310x120x300	355x130x215	360x160x260	480x210x305	515x245x415	544x280x435	535x310x390
Weight	7.5 kg	4.5 kg	6.5 kg	12 kg	18 kg	22 kg	27 kg

Band III

Size		3 1/8" EIA	4 1/2" EIA	6 1/8" EIA	7 3/16" ¹	8 3/16" ¹	
Impedance		50 Ω	50 Ω	50 Ω	75 Ω	75 Ω	
Proof voltage		14 kV	18 kV	22 kV	34 kV	38 kV	
Avg. power (at 254 MHz)		44 kW	64 kW	100 kW	132 kW	167 kW	
VSWR		1.06					
Dimension (LxWxH) mm		335x130x236	360x160x235	460x210x270	515x245x325	565x280x345	
Weight		5 kg	6.5 kg	12 kg	18 kg	22 kg	

Band IV / V

Size	1 5/8" EIA	3 1/8" EIA	4 1/2" EIA	6 1/8" EIA	7 3/16" ¹	8 3/16" ¹	
Impedance	50 Ω	50 Ω	50 Ω	50 Ω	75 Ω	75 Ω	
Proof voltage	7 kV	16 kV	22 kV	22 kV	30 kV	34 kV	
Avg. power (at 800 MHz)	7 kW	20 kW	40 kW	65 kW	77 kW ²	101 kW ³	
VSWR	1.06						
Dimension (LxWxH) mm	310x120x300	335x195x200	360x160x250	460x210x290	515x245x355	545x280x375	
Weight	7.5 kg	6 kg	9 kg	12 kg	19 kg	20 kg	

¹ Can be pressurized up to 0.35 bar (5 psig)

² Avg. power at 746 MHz

³ Avg. power at 698 MHz

AMS Antenna Monitoring System

AMS U-link

AMS detector for mounting on SPINNER patch panels

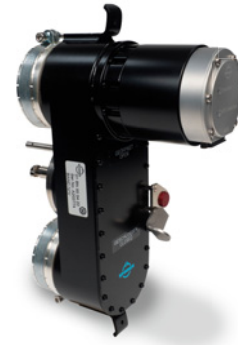

General Information

Interlock types	Interlock 1, interlock 2
Versions	USL-D, USL
Material and surface	Aluminum alloy
IP protection level	IP 50 per EN 60529
Interface	D-SUB 15 socket

Band II

Size	1 5/8"	29.5 - 68	43 - 98
Impedance	50 Ω		
Test voltage	7 kV	13.5 kV	8 kV
Avg. power (at 108 MHz)	20 kW	51 kW	98 kW
VSWR	1.06		
Dimensions (LxWxH), mm	295 x 105 x 205	295 x 105 x 205	395 x 140 x 270
Weight	2.5 kg	2.6 kg	7 kg

Band III

Size	1 5/8"	29.5 - 68
Impedance	50 Ω	
Test voltage	5.5 kV	
Avg. power (at 254 MHz)	13 kW	33 kW
VSWR	1.06 ¹	
Dimensions (LxWxH), mm	295x 105 x 205	295 x 105 x 205
Weight	2.5 kg	2.6 kg

Band IV/V

Size	1 5/8"	29.5 - 68	43 - 98	52 - 120
Impedance	50 Ω			
Test voltage	7 kV	13 kV	19 kV	25 kV
Avg. power (at 800 MHz)	7 kW	17.5 kW	35 kW	60 kW
VSWR	1.06			
Dimensions (LxWxH), mm	295 x 105 x 205	295 x 105x 205	395 x 140 x 258	570 x 180 x 310
Weight	2.5 kg	2.6 kg	7 kg	11.5 kg

¹ 1.09 from 240 MHz to 254 MHz



AMS Antenna Monitoring System

Part Numbers

The AMS can be only ordered as a kit, consisting of control unit and one or two AMS detectors.
For spare parts or accessories, please see page 12.

Basic Number							AMS Detector (AMS Line Section or AMS U-Link)				
							Size	Type	Quantity	Version	
5	5	5	X	X	X	C	X	X	X	X	
AMS kit for band II			0	2	2						
AMS kit for band III			0	3	2						
AMS kit for band IV/V			0	4	2						
AMS line section		AMS U-link									
1 5/8" EIA		1 5/8"						1			
3 1/8" EIA		29.5-68						3			
4 1/2" EIA		43-98						4			
6 1/8" EIA		52-120						5			
(reserved for internal use)								6			
7 3/16"								7			
8 3/16"								8			
9 3/16"								9			
AMS U-link - interlock 1									1		
AMS U-link - interlock 2									2		
AMS line section - 50 Ohm									3		
AMS line section - 75 Ohm									4		
No. of AMS detectors (control unit can connect up to 2 AMS detectors)											
To be completed by SPINNER											

Scope of Delivery

Control unit, line adapter, power cord (EU and USA), AMS detector(s), D-SUB 15 connection cable(s) - 5 m

AMS Antenna Monitoring System

Schematic AMS Power Monitoring Add-On

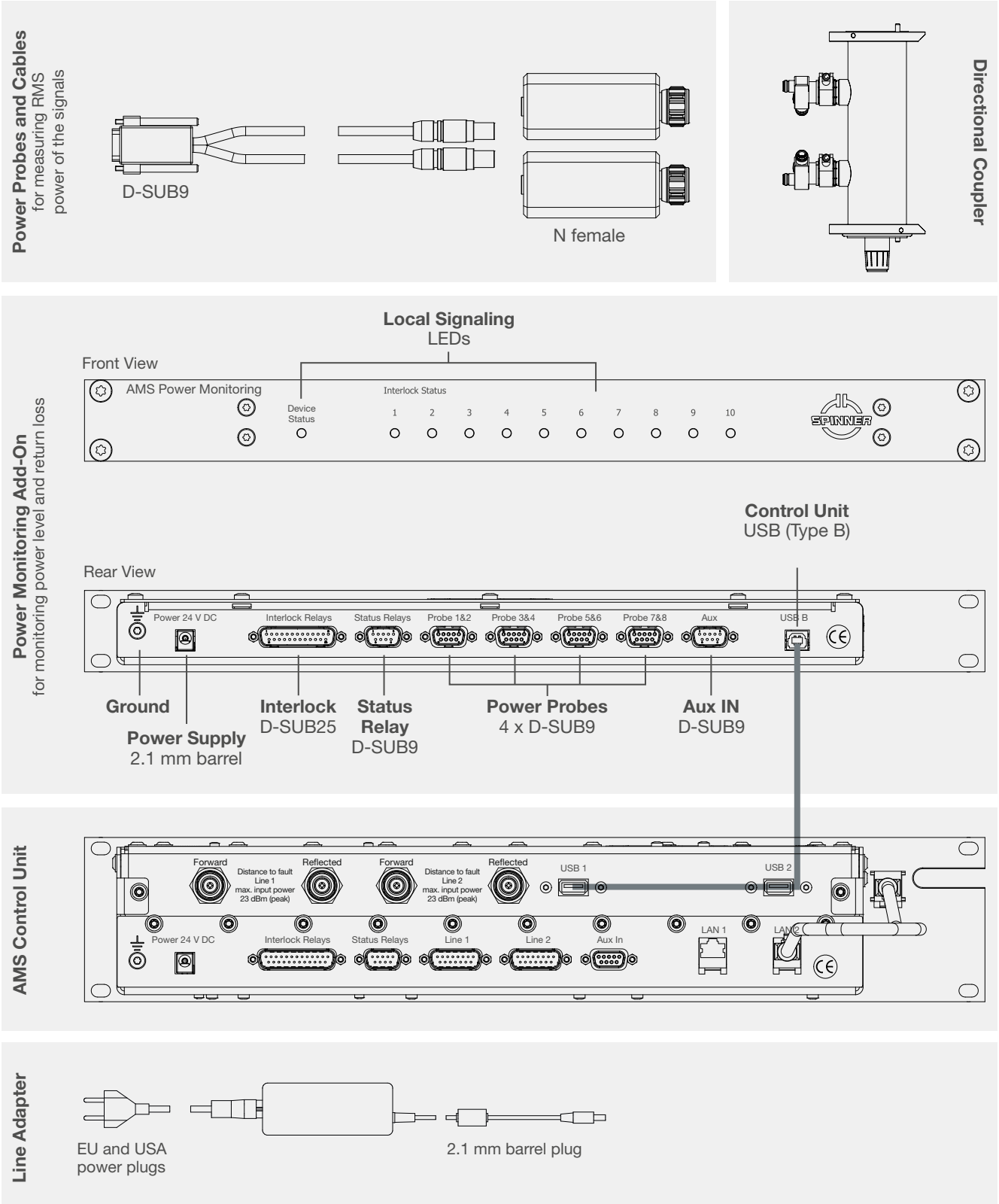

Antenna Monitoring System

AMS Antenna Monitoring System

AMS Power Monitoring Add-On

Monitors power level and return losses up to four RF channels (eight RF probes). It triggers user-definable warnings and alarms.



General Data

Part number	BN 555050C0000
Frequency range	50 MHz - 860 MHz
RF channels	Up to 4 channels (8 power probes)
Absolute power measurement accuracy	± 2.0 dB
Relative power measurement accuracy	± 0.5 dB
Power correction (over frequency)	-6 dB / octave
Polling rate via SNMP	6 s

Mechanical Data

Dimensions (L x W x H) mm	158 x 483 x 44 mm (19", 1RU)
Weight	1.6 kg
IP class	IP 40 per EN 60529

Electrical Data

Line adapter voltage	80 V AC to 264 V AC, 47 to 63 Hz, 113 V DC to 370 V DC
Line adapter interface	Power cords for USA, EU and UK (on request)
Power consumption, max.	10 W

Interfaces

Interlock	D-SUB 25 plug 10 potential-free relay contacts, open active, max. 42.4 V ACpk / 60 V DC, 0.5 A, SELV
Relay status	D-SUB 9 plug 3 potential-free relay contacts, open active, max. 42.4 V ACpk / 60 V DC, 0.5 A, SELV
Power probes	8 x N female (50 Ohm)
Data interface to AMS control unit	USB type A, USB type B

AMS Antenna Monitoring System

AMS Power Probes & Cables

For measuring RMS signal power



FM and VHF Probes

Part number	BN 155891
Frequency range	50 MHz - 250 MHz
Power measurement range	-29 dBm to +15 dBm
Coaxial interface connector	1 x N female (50 Ω)
Dimensions (L x W x H) mm	90 x 35.5 x 26
Weight	155 g

UHF Probes

Part number	BN 155892
Frequency range	470 MHz - 860 MHz
Power measurement range	-34 dBm to +10 dBm
Coaxial interface connector	1 x N female (50 Ω)
Dimensions (L x W x H) mm	90 x 35.5 x 26
Weight	155 g

Connecting Cable

Part number	BN A75049	BN A75069	BN A76392
Type	Single cable 1 x Lemo FGG to D-SUB 9 2 metres	Y-cable 2 x Lemo FGG to D-SUB 9 2 metres	Y-cable 2 x Lemo FGG to D-SUB 9 5 metres

AMS Antenna Monitoring System



AMS tester

Spare Parts and Accessories

AMS tester for testing the AMS functionality	BN 555010
Cable from control unit to AMS detector (length: 5 meters)	BN A75695
Cable from control unit to AMS detector (length: 30 meters)	BN A75696
Mains adapter	BN A76170
Power cord Europe	BN A76167
Power cord UK	BN A76168
Power cord North America	BN A76169
Directional couplers	See chapter "Adapters and Measurement Accessories"

Environmental Conditions

Operational conditions	ETSI EN 300 019-4-3 V2.3.2 (2009-1) class 3.1 N
Ambient temperature range	-10 °C to +45 °C
Relative humidity, max.	95 % (non-condensing)
De-rating of RF power and voltage with increasing altitude	See "Environmental Conditions for Broadcast Products" TD-00060.
Transport conditions	ETSI EN 300 019-1-2 V2.1.4 (2009-1) class 2.2
Ambient temperature range	-25 °C to +70 °C
Rain, condensation, icing	Not allowed
Storage conditions	ETSI EN 300 019-1-1 V2.1.4 (2009-1) class 1.2
Ambient temperature range	-10 °C to +45 °C
Rain, condensation, icing	Not allowed
Safety	EN 60125 (1994) / IEC 215 (1993)

Applicable Documents

Product manual AMS incl. AMS power monitoring	M36557
Product manual AMS tester	M36274

Channel Combiners

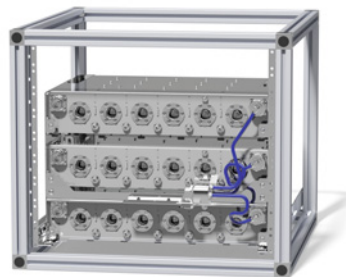

SPINNER offers different types of combiners such as starpoint, manifold and CIB combiners with constant impedance. Most of the combiners are supplied with integrated mask filters.

Multichannel Combiners

In order for multiple transmitters to broadcast via a shared antenna, it is necessary to connect the transmitter outputs using a combiner so that they can't interfere with one another (isolation), and to route all of the RF power to the antenna (insertion loss).

Bandpass filters or phase-adjusted transmission lines are used to set the frequencies in the combiners.

The bandpass filters can also be used to suppress spurious emissions (with integrated mask filtering for DTV, DAB, T-DMB etc.).

Channel Combiners

Starpoint and Manifold Combiners

Transmitters can be isolated from each other by connecting a bandpass filter to each output. To achieve good matching for the operating channels, the outputs of these filters must be connected via a suitable matching network.

It's important to keep in mind that this system will exhibit a total mismatch outside the operating channels, due to total reflection by the bandpass filters.

Frequency changes or extensions are difficult to accomplish with combiners of these kinds, because the matching networks have to be optimized for the new frequencies.

Constant Impedance Broadband (CIB) Combiners

Good isolation, broadband matching and easy modification can be achieved in the CIB combiner with a combination of bandpass filters and 3 dB couplers.

The signal applied to the narrowband input is fed via the narrowband 3 dB coupler into the two bandpass filters, then recombined afterwards in the wideband 3 dB coupler and routed to the antenna output.

The signals fed into the wideband input arrive at the filter ports via the wideband 3 dB coupler, which totally reflects them back to the wideband coupler. They are then routed to the antenna output.

All of the ports are broadband-matched (yielding constant impedance across a broad band).

Any transmitter signal can be fed into the wide-band input as long as the frequency spacing across the filters' pass-band range is large enough to ensure total reflection. Even adjacent channels can be combined if the slopes of the filter curves are steep enough. CIB combiners are the preferred components for designing multichannel combiners because they provide the greatest flexibility for configuring channels and power levels.

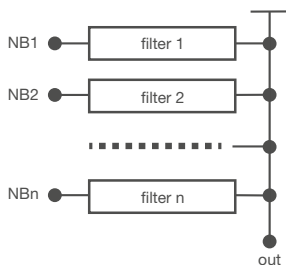

Manifold combiner

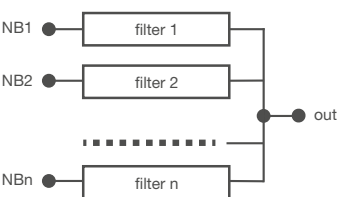

Starpoint combiner

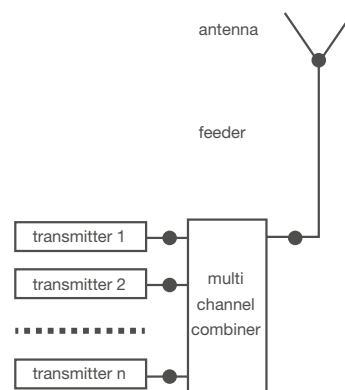

Multichannel combiner

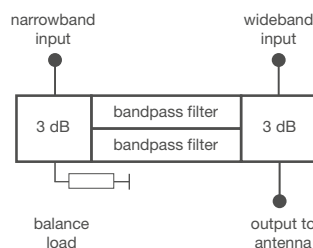

Constant impedance broadband combiner

Channel Combiners

Stretchline Combiners

Stretchline combiners take advantage of the differences in wavelength among transmitter frequencies. The signals are split by the first 3 dB coupler and output to two transmission lines. The phases at the input to the second 3 dB coupler are modified by carefully adjusting the line lengths for routing the signals to the antenna output. Stretchline combiners have very low insertion loss and a high power rating, but can only combine channels spaced by more than 3 channels.

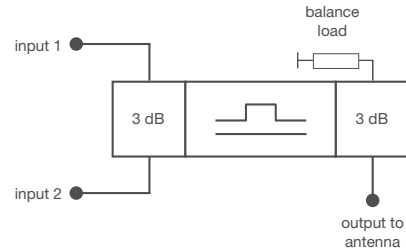

Multi Channel Combiners

Combinations of Multiple Combiners

CIB combiners can be almost arbitrarily cascaded. Additional units can be connected to the wideband input or the output. Starpoint, manifold and stretchline combiners can be connected to the wideband input of CIB combiners to add even more channels.

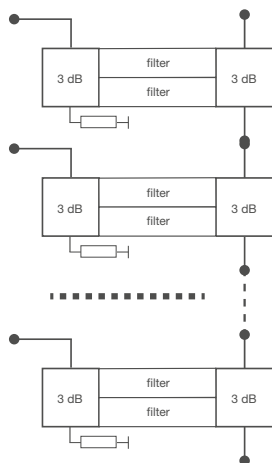

Chain of CIB combiners

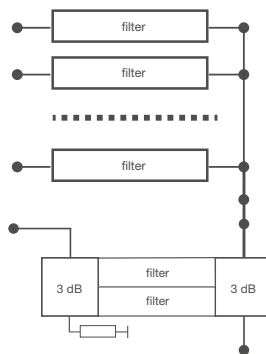

Manifold and CIB combiner

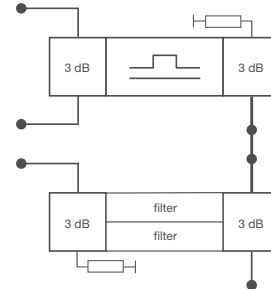

Stretchline and CIB combiner

How to Choose the Right Combiner Type

Start by making a list of channels, powers and masking requirements:

Channel	Power	Mask Requirement
23	2 kW	DVB
27	2 kW	DVB
28	10 kW	No
57	1 kW	DVB

If the list contains adjacent channels, they have to be combined using CIB combiners. If mask filters are required, it's preferable to integrate them into the starpoint, manifold or CIB combiner to minimize overall insertion loss while maximizing flexibility for combining channels.

Stretchline combiners and the wide-band inputs of CIB combiners don't provide mask filtering. Appropriate band-pass filters therefore have to be connected to the inputs

to meet masking requirements. After choosing a combiner type (CIB, starpoint, manifold or stretchline), you need to select a model with an adequate power rating.

SPINNER's combiner engineers will be happy to help you select and plan combiner systems. Please send a table indicating the channels and specifications to info@spinner-group.com.



Explanation of the Multi-Channel Combiner Specifications

Calculation of maximum permissible output voltages

Various signals are added up within the combiner. The peak voltages of the individual signal must be calculated and added up. These voltages should not be calculated on the basis of the combined power, since this would result in figures that are too low. It's important for the sum to be less than the rated maximum output voltage. SPINNER recommends a safety margin of 20 %.

Calculation of maximum permissible power at the narrowband input of starpoint, manifold and CIB combiners

The power is limited by the filters. All of the power ratings cited in this catalog are RMS values. If a signal's RMS value differs from the nominal value, correction factors have to be applied (for example, an analog TX with 10/1 kW of nominal power yields only 7 kW of RMS power).

Generally speaking, the RMS power given in the data sheet can be applied. The only exception is for adjacent channels, which may require a reduction as explained below.

Calculation of the maximum permissible power at the wideband input of CIB combiners

All of the power ratings cited in this catalog are RMS values. If a signal's RMS value differs from the nominal value, correction factors have to be applied (for example, an analog TX with 10/1 kW of nominal power yields only 7 kW of RMS power).

Different power levels are usually fed to the combiner inputs: Only one transmitter feeds the narrowband input, while the combined power of two or more transmitters is fed into the wideband input.

To check whether a given CIB combiner model is appropriate, you need to subtract 50% of the narrowband power from the maximum wideband power indicated on the data sheet. If the resulting value is too small, you should select a larger combiner model.

Example:

Power at narrowband input in kW: ≤ 4.0

Power at wideband input in kW: ≤ 7.0

Possible combinations:

Narrowband input in kW: 0.0 1.0 2.0 3.0 4.0

Wideband input in kW: 7.0 6.5 6.0 5.5 5.0

SPINNER recommends maintaining a safety margin of 20 %.

Adjacent channel operation with CIB combiners

CIB combiners are most qualified for combining adjacent channels or blocks. The slope of an adjacent channel fed into the wideband input is not entirely reflected by the bandpass filters. A small portion of the signal enters the filter and is converted into heat. This effect is called "adjacent channel loss". This load on the bandpass filters must be taken into account. To compensate for it, the maximum permissible narrow band power must be reduced by 10 % to 30 % of the adjacent channel power that is fed to the wideband input.

Matching of CIB combiners at the wideband input

To optimize matching for the operating channels, unused channels are capped. It is therefore important to specify all planned operating frequencies when ordering. The VSWR indicated on the data sheet is only guaranteed for one single channel at the wide-band input.

Tuning specifications for filters and combiners

Filters must be tuned to the right channel bandwidth to meet masking requirements. The required information is defined by the tuning specifications (e.g. AS6148), which must be indicated when placing an order. The catalog contains filter data for the most common applications. However, other filter tunings are possible for other masking requirements, applications and bandwidths. Please don't hesitate to contact us for advice.

Solutions for Low- and Medium-Power Combiners

SPINNER offers a complete range of low- and medium-power combiners:

- 1 W to 5 kW
- Band 3, UHF and Band L
- ATV, DAB and DTV

All of the following are available:

- Stretchline combiners without mask filtering
- Starpoint combiners made of DAB and DTV mask filters
- Manifold combiners with and without DTV mask filtering
- CIB combiners with and without DAB or DTV mask filtering

Compact combiners can be installed in various ways:

- Inside 19" racks
- On walls
- On floors

Multiple combiner units can be stacked vertically (either in a 19" rack or self-supporting) or attached to walls to minimize their footprint.

The 19" slide-in combiners come in three different versions:

- BN 57___ without a front plate
- BN 57___ C0001 with a front plate and RF ports at the front
- BN 57___ C0002 with a front plate and RF ports at the back

All SPINNER combiner systems comprising multiple units are assembled, tuned and measured in the factory before shipping. SPINNER delivers complete systems that can be easily installed by any skilled technician.

The customer receives complete test results for insertion loss, mask filtering and matching, which can be checked before beginning installation and compared afterward with the on-site results.

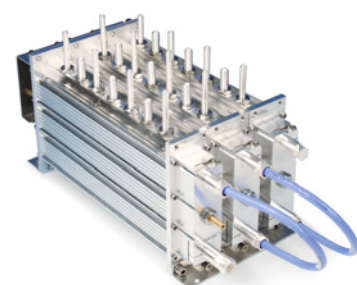

BN 574583
UHF 3-way manifold combiner



BN 574586
UHF 6-way manifold combiner



BN 574605C0001
UHF CIB combiner with 4 cavity filters



BN 574606C0001
UHF CIB combiner with DTV mask filter

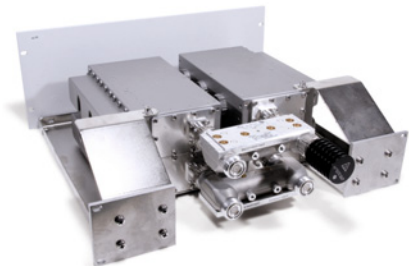

BN 574948C0002
UHF CIB combiner with DTV mask filters



BN 574942C0001
UHF CIB combiner with DTV mask filters

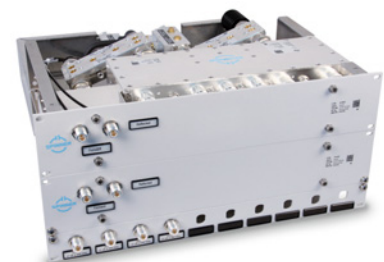

BN 574839
UHF 3-way combiner with integrated DTV mask filters and monitoring

Multi Channel Combiners

Solutions for Low- and Medium-Power Combiners

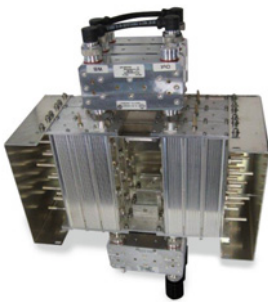

BN 574590
UHF 4-way CIB combiner
in wall mount



BN 574878
UHF 6-way combiner
with integrated DTV mask filters



BN 575481
Band 3 4-way combiner
with integrated DAB mask filters



BN 575272
5-way combiner
with integrated DTV mask filters



BN 575623C1000
Double UHF 6-way combiner
with integrated DTV mask filters
and N+1 switching system

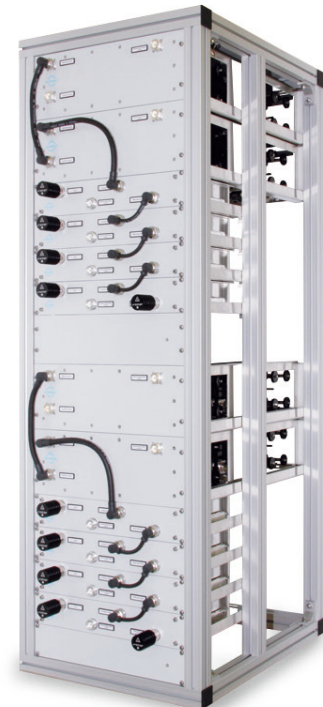

BN 574598
Double UHF 6-way combiner
with integrated DVB mask filters

Solutions for Compact Combining and Switching Systems for 1 kW to 80 kW

This modular system of combiners and patch panels makes it possible to implement all functions with a minimal footprint.

SPINNER has standardized and miniaturized its combiners and patch panels to the point that combining, mask filtering and many switching functions can be implemented with a footprint of only half a square meter per channel. This design, called CCS, has many advantages:

- It's very simple to plan combiners because 0.5 m² per channel is enough.
- DTV mask filtering (to meet uncritical or critical requirements) can be integrated in the CCS combiner module without increasing its footprint.
- CCS combiner modules are available for up to 80 kW of combined power at one output. For higher power levels in parallel, phase-equalized combiner chains can be created.
- CCS systems can be equipped with monitoring couplers, trimming lines and other accessories.
- Installation is very simple because the CCS modules are supplied as easy-to-handle individual units. On site, the combiner modules only need to be attached to the bottom frame and connected to prefabricated rigid lines. Consequently, even complex combiner systems can be installed ready-to-go in a day or less.
- It's quick, easy and inexpensive to install interconnect lines between the transmitters and antenna because all RF ports are freely accessible at the top. A single vertical length of rigid line is enough for each port.
- Optionally available CCS patch panels make it straightforward to connect reserve operation facilities, bypass individual combiner modules, switch to a common dummy load, or precisely measure combiner performance without disconnecting any rigid lines.
- Off-air times for frequency changes and other modifications can be reduced to minutes when using CCS patch panels.
- The standardized design also makes it easy to replace combiner modules if it should later become necessary to operate adjacent channels or increase power levels.

SPINNER CCS systems deliver enormous benefits for network operators by facilitating planning, installation, operation and future expansion. All of these advantages should be taken into account when comparing with competing products.



Testing in the factory

Multi Channel
Combiners



Transportation



Ready for operation on site

Solutions for Compact Combining and Switching Systems for 1 kW to 80 kW

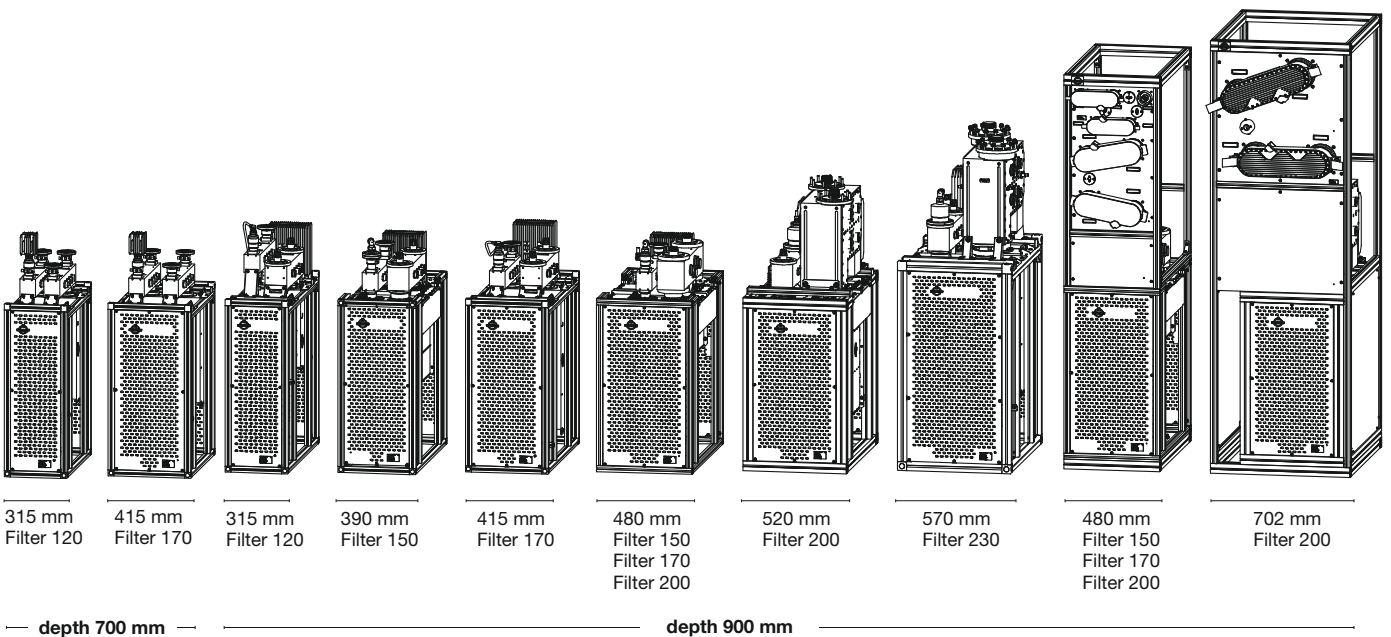
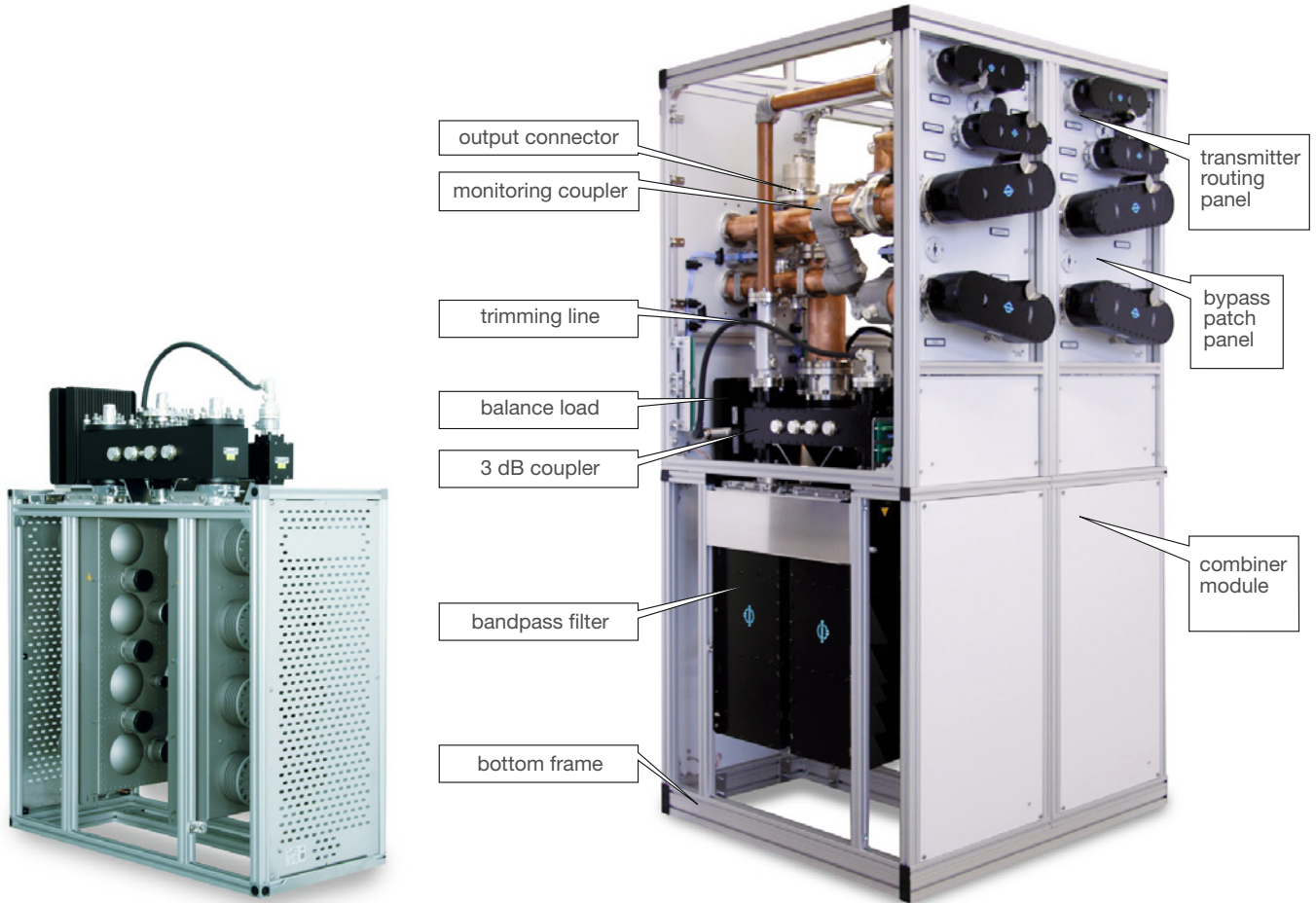

Solutions for Compact Combining and Switching Systems for 1 kW to 80 kW

CCS System without Patch Panels: Minimum Configuration

For a straightforward system, combiner modules can be connected by simple rigid lines. Systems of this kind are very efficient, but it is necessary to interrupt transmission to make measurements or modifications.

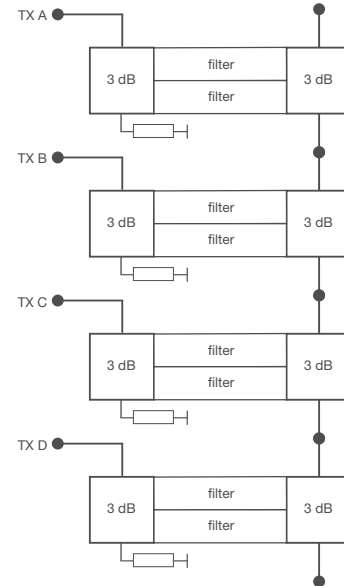

Multi Channel Combiners

CCS System with Combiner Bypass Patch Panels for Greater Availability

To increase a combiner system's uptime, every combiner module can be equipped with a four-port patch panel. Then any combiner can be bypassed in minutes to enable measurements or frequency changes.

Transmission of the other channels can resume within minutes, and you can even continue transmitting the bypassed channel by feeding it into the free wideband input.

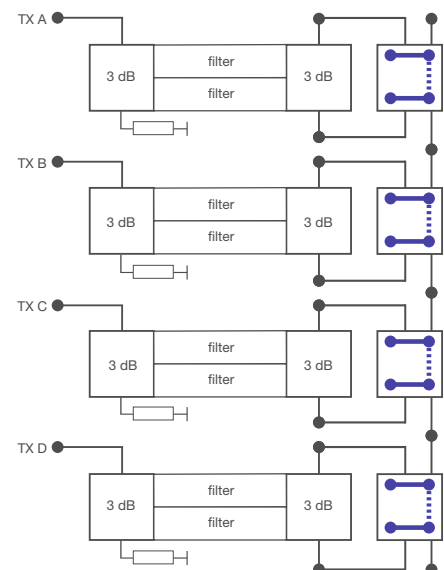

Solutions for Compact Combining and Switching Systems for 1 kW to 80 kW

CCS System with Transmitter Routing and Combiner Bypassing Patch Panels for Maximum Flexibility

For maximum flexibility, a combiner module can be equipped with four-port patch panels on the input and output sides.

Transmitter routing on the input side:

- For normal operation, the transmitter is directly connected to the combiner input.
- For measurements, the transmitter signal can be switched to a common dummy load.
- For frequency changes, the transmitter can be switched to the wideband input of the combiner system so operation can continue while the combiner unit is being retuned.

Combiner bypassing on the output side:

- During normal operation, the module remains in the combiner chain.
- To make measurements or frequency changes, the combiner module is bypassed and isolated.

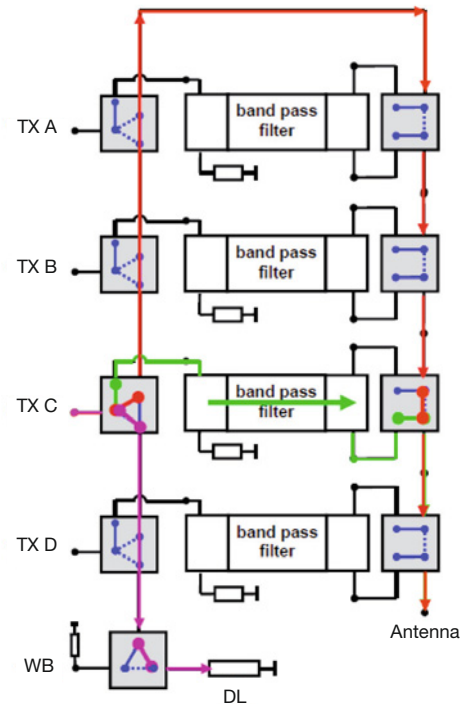
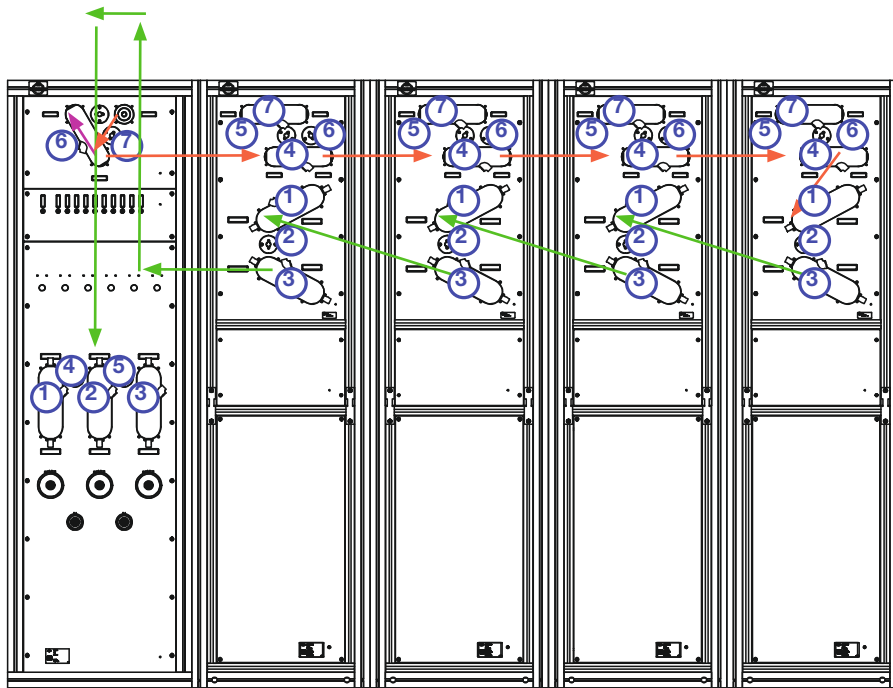

- Standard operation: Transmitter via combiner to antenna
- Transmitter measurements: Transmitter routed to common dummy load
- Combiner measurement or retuning: Operation continues via the system's wideband input while the combiner module is bypassed.

Solutions for Compact Combining and Switching Systems for 1 kW to 80 kW

Multi Channel Combiners



Single UHF CIB combiner unit



BN 575402 Rennes, France
UHF combiner for 8 x 5.6 kW DVB with integrated mask filters and monitoring couplers



BN 575306 Turkmenistan
UHF combiner for 8 x 4 kW DVB with integrated mask filters, combiner bypass and antenna patch panel with bent front for installation in circular transmitter hall



front side



rear side

BN 575265 Argentina
UHF combiner for 4 x 2 kW ISDB-T (expandable to 8 x 2 kW) with integrated 8 cavity mask filter and N+1 switching and dummy load for testing

Solutions for Compact Combining and Switching Systems for 1 kW to 80 kW



Front side

Rear side

BN 575496 Russia

UHF Combiner for 5 kW DVB with integrated mask filters and 20 kW ATV, combiner bypass and antenna patch panel and 10 kW dummy load



BN 575626 Pfänder, Austria

Band 3 combiner for 5 x 2.5 kW DAB (expandable to 10 x 2.5 kW DAB) with integrated mask filters and antenna patch panel



BN 575637 South Africa

UHF combiner for 3 x 3 kW DVB with integrated liquid cooled filters



BN 575084 Pontop Pike, England

UHF combiner for 3 x 15 kW DVB with integrated liquid cooled filters, input isolation U-links and pump unit



BN 574472 Knockmore, Scotland

Double UHF combiner for 6 x 1.7 kW DVB with integrated 8 MHz DVB mask filters 2 port input isolation patch panel

Design and Offers

It takes considerable knowledge and experience to design multichannel combiner systems with good technical performance and efficiency. The following aspects have to be taken into account:

- Power of the individual signals
- Voltage of the individual signals
- Frequency spacings (between adjacent channels)
- Requirements for mask filtering
- Patch panels for emergency operation
- Space requirements
- Future frequency changes or extensions
- Performance of combiners, patch panels, etc.

When designing an entire transmission station, the combiner system's specifications (insertion losses and matching) have to be defined in the planning stage.

SPINNER has a team of experienced RF engineers who devote themselves to designing combiner systems. Please send us your requirements and we will prepare an offer along with detailed technical and mechanical specifications like those in the data sheet on the next page.

A complete combiner system is shown in the picture below.

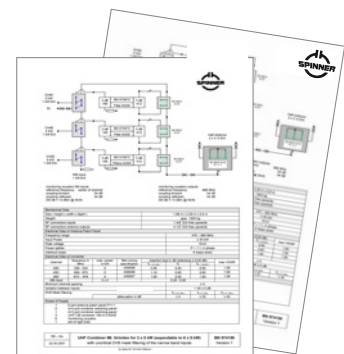

Example:

UHF combiner for 3 x 5 kW DVB
for adjacent channel operation
with integrated 8 MHz DVB mask filters
4 port combiner bypass patch panels
4 port TX rerouting patch panels
6 port half antenna patch panel



Design and Offers

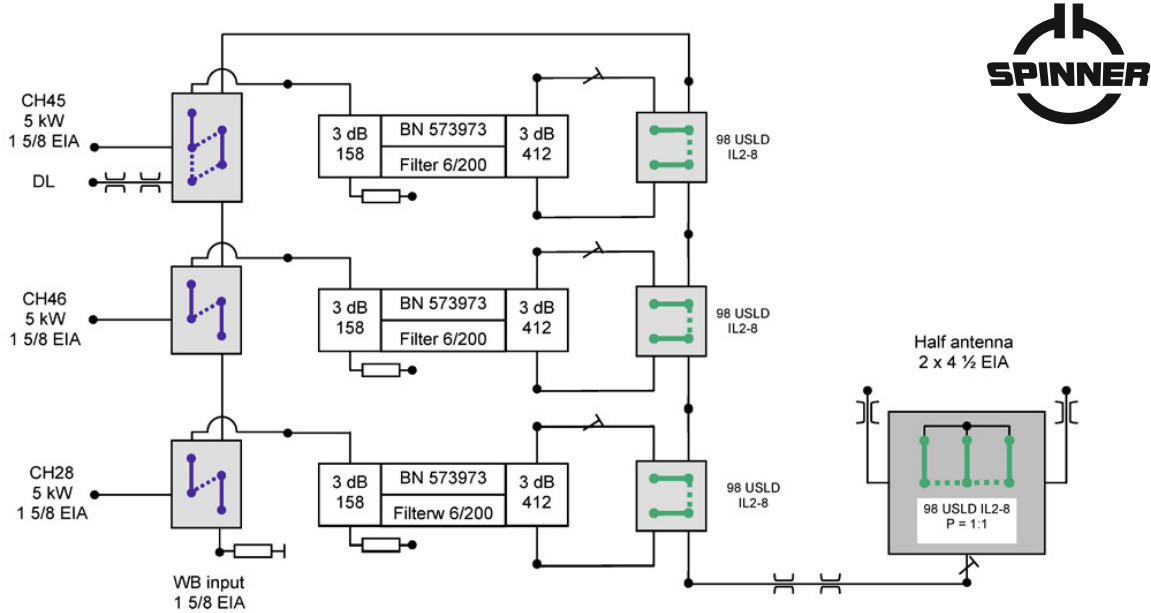

monitoring couplers NB inputs:
 reference frequency center of channel
 coupling forward 54 dB
 coupling reflected 54 dB
 (54 dB = 13 dBm @ 5kW)

monitoring couplers outputs:
 reference frequency 666 MHz
 coupling forward 54 dB
 coupling reflected 54 dB
 (54 dB = 13 dBm @ 5kW)

Mechanical Data							
Size (height x width x depth)		1,98 m x 2,29 m x 0,9 m					
Weight		appr. 1000 kg					
RF connectors inputs		1 5/8" EIA free upwards					
RF connectors antenna outputs		4 1/2" EIA free upwards					
Electrical Data of Antenna Patch Panel							
Frequency range		470 – 860 MHz					
Input Power		≤ 35 kW					
Peak voltage		19 kV					
Power splitter		P = 1:1, in phase					
Interlock loops		6 loops wired					
Electrical Data of Combiner							
channel	frequency in MHz	max. power in kW	filter tuning specification	insertion loss in dB (tolerance ± 0,05 dB)			max VSWR
				f ₀ - 3,8 MHz	f ₀	f ₀ + 3,8 MHz	
28D	526 - 534	5	AS6006	0,90	0,40	0,90	1,06
45D	662- 670	5	AS6006	1,10	0,60	2,60	1,08
46D	670 - 678	5	AS6007	1,50	0,50	1,50	1,08
WB input		3 x 5		0,30 - 0,50			
Minimum channel spacing		≥ 0					
Isolation between inputs		> 40 ± 5 dB					
DVB Mask filtering				f ₀ ± 4,2 MHz	f ₀ ± 6 MHz	f ₀ ± 12 MHz	
		attenuation in dB		≥ 4	≥ 20	≥ 40	
Scope of Supply							
1	6 port antenna patch panel P=1:1						
2	4+4 port combiner switching panel						
1	4+5 port combiner switching panel						
3	UHF CIB combiner 158-412 6/200						
6	monitoring couplers						
1	set of rigid lines						

	UHF Combiner Mt. Grütten for 3 x 5 kW (expandable to 6 x 5 kW) with uncritical DVB mask filtering of the narrow band inputs	BN 574156 Version 1
22.05.2007		

CCS Band 3 Stretchline Combiners

- Compact design
- Suitable for ATV and DTV
- For 6 and 7 MHz channel bandwidth

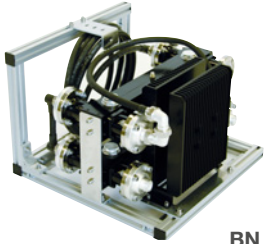
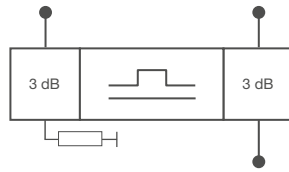

BN 574681

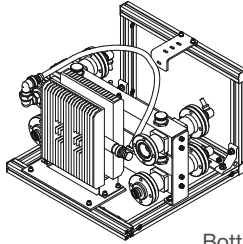

Bottom mounting

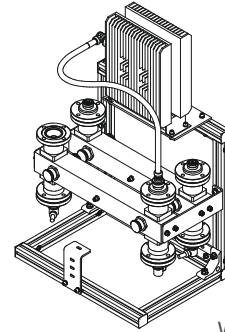

Wall mounting

Multi Channel
Combiners

Part Number	BN 574681
Frequency range	174 - 240 MHz
Channel spacing	≥ 2
Narrowband input	7-16 female
Average input power	≤ 2 kW
Mask filtering	No
Insertion loss	Typically ≤ 0.5 dB
Output	1 5/8" EIA
Peak output voltage	≤ 3.5 kV
Isolation between inputs	≥ 32 dB
VSWR	≤ 1.06
Dimensions (L x W x H) mm	≈ 486 x 460 x 350
Weight	≈ 26 kg
Environmental conditions	For limitations see „Environmental Conditions for Broadcast Products“.

Band 3 DAB Starpoint Combiners

- Compact design as 19" slide-in unit
- For 1.54 MHz block width
- Integrated mask filters for DAB and T-DMB
- Temperature compensated

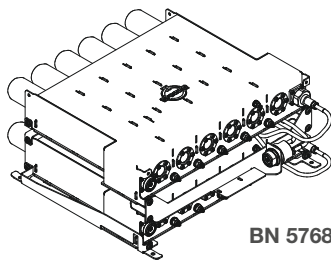
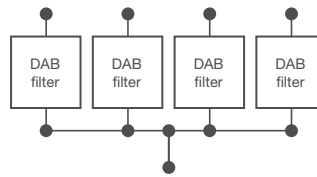

BN 576805

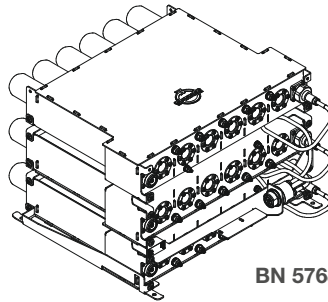

BN 576806

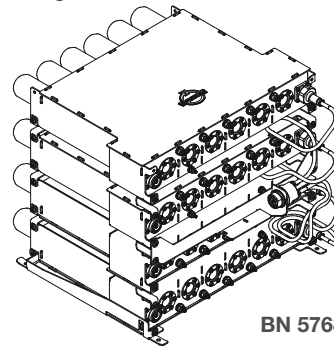

BN 576807

Part Number	BN 576805 2 Inputs	BN 576806 3 Inputs	BN 576807 4 Inputs												
Frequency range	174 - 240 MHz														
Block Spacing	≥ 1														
Narrowband input	7-16 female														
Filter type integrated	6/70 ≡ BN 617129														
Temperatur stability	≤ 1 kHz / K														
Harmonics attenuation	≥ 50 dB for f ≤ 500 MHz														
Standard	DAB / T-DMB @ 1.54 MHz / (Û/U _{rms} =13 dB)														
Average input power	300 W per input														
Channel spacing	≥ 1														
Tuning instruction	AS6547														
Insertion loss and mask filtering	<table border="0"> <tr><td>f₀</td><td>≤ 1.5 dB</td></tr> <tr><td>f₀ ± 0.77</td><td>≤ 3.6 dB</td></tr> <tr><td>f₀ ± 0.97</td><td>≥ 15 dB</td></tr> <tr><td>f₀ ± 1.75</td><td>≥ 45 dB</td></tr> <tr><td>f₀ ± 2.2</td><td>≥ 50 dB</td></tr> <tr><td>f₀ ± 3.0</td><td>≥ 50 dB</td></tr> </table>			f ₀	≤ 1.5 dB	f ₀ ± 0.77	≤ 3.6 dB	f ₀ ± 0.97	≥ 15 dB	f ₀ ± 1.75	≥ 45 dB	f ₀ ± 2.2	≥ 50 dB	f ₀ ± 3.0	≥ 50 dB
f ₀	≤ 1.5 dB														
f ₀ ± 0.77	≤ 3.6 dB														
f ₀ ± 0.97	≥ 15 dB														
f ₀ ± 1.75	≥ 45 dB														
f ₀ ± 2.2	≥ 50 dB														
f ₀ ± 3.0	≥ 50 dB														
Group delay variation	Δτ ≤ 1200 ns														
Output	7-16 female														
Isolation between inputs	≥ 35 dB														
VSWR	≤ 1.2														
Dimensions (L x W x H) mm	500 x 448 x 200	500 x 448 x 305	500 x 448 x 415												
Weight	≈ 43 kg	≈ 62 kg	≈ 82 kg												
Environmental conditions	For limitations see „Environmental Conditions for Broadcast Products“.														

Band 3 DAB Starpoint Combiners

- Compact design
- For 1.54 MHz block width
- Integrated mask filters for DAB and T-DMB
- Temperature compensated

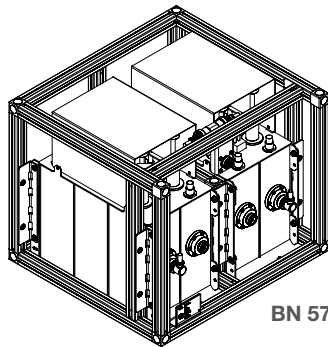
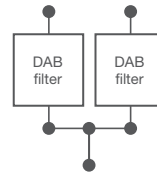

BN 574904

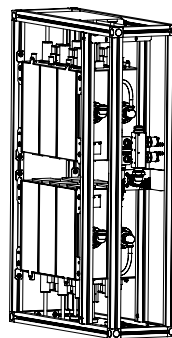

BN 574904A0000

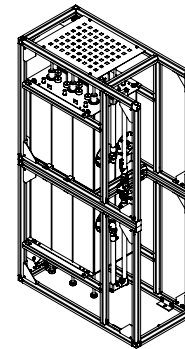

BN 574680

Multi Channel Combiners

Part Number	BN 574904	BN 574904A0000	BN 574617	BN 574680
Frequency range	174 - 240 MHz			
Block spacing	≥ 1			
Narrowband inputs	7-16 female			
Filter type integrated cavities/size	6/100 ≡ BN 617116 with cross coupling		6/150 ≡ BN 617171 without cross coupling	6/150 ≡ BN 617144 with cross coupling
Temperature stability	≤ 1 kHz / K			
Harmonics attenuation	≥ 50 dB for f ≤ 500 MHz			
DAB and T-DMB mask filtering	DAB / T-DMB @ 1.54 MHz (Ü/U _{rms} =13 dB)			
Average input power	≤ 600 W		≤ 1.5 kW	≤ 1.6 kW
Tuning instruction	AS6033		AS6010	AS6137
Insertion loss & mask filtering (alternative tuning on request)	$f_0 \leq 1.0$ dB $f_0 \pm 0.77 \leq 2.3$ dB $f_0 \pm 0.97 \geq 15$ dB $f_0 \pm 1.75 \geq 45$ dB $f_0 \pm 2.2 \geq 53$ dB $f_0 \pm 3.0 \geq 53$ dB		$f_0 \leq 1.0$ dB $f_0 \pm 0.77 \leq 1.6$ dB $f_0 \pm 0.97 \geq 8$ dB $f_0 \pm 1.75 \geq 43$ dB $f_0 \pm 2.2 \geq 53$ dB $f_0 \pm 3.0 \geq 73$ dB	$f_0 \leq 0.75$ dB $f_0 \pm 0.77 \leq 1.6$ dB $f_0 \pm 0.97 \geq 15$ dB $f_0 \pm 1.75 \geq 45$ dB $f_0 \pm 2.2 \geq 58$ dB $f_0 \pm 3.0 \geq 52$ dB
Group delay variation	$\Delta\tau \leq 1200$ ns		$\Delta\tau \leq 700$ ns	$\Delta\tau \leq 1000$ ns
Output	7-16 female			
Isolation between inputs	≥ 35 dB			
VSWR	≤ 1.2			
Dimensions (L x W x H) mm	550 x 448 x 500	660 x 220 x 950	800 x 390 x 1420	
Weight	≈ 55 kg		≈ 90 kg	
Environmental conditions	For limitations see „Environmental Conditions for Broadcast Products“.			

Band 3 DAB Starpoint Combiners

- Compact design
- For 1.54 MHz block width
- Integrated mask filters for DAB and T-DMB
- Temperature compensated
- Filters with cross coupling (notch function)

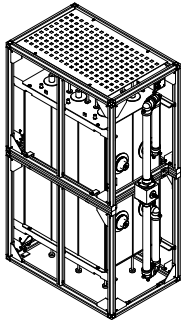
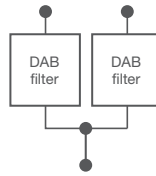

BN 576802

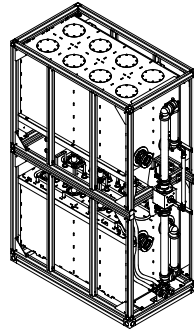

BN 576831

Part Number Cooling	BN 576802 Natural cooling	BN 576803 Natural cooling	BN 576830 Liquid cooling	BN 576831 Liquid cooling
Frequency range	174 - 240 MHz			
Block spacing	≥ 1			
Narrowband input	1 5/8" EIA			
Filter type integrated cavities/size	6/200 ≡ BN 617166	8/200 ≡ BN 617168	6/200 ≡ BN 617166	8/200 ≡ BN 617168
Temperature stability	≤ 1 kHz / K			
Harmonics attenuation	≥ 50 dB for f ≤ 500 MHz			
DAB and T-DMB mask filtering	DAB / T-DMB @ 1.54 MHz / (Û/U _{rms} =13 dB)			
Average input power	≤ 3.0 kW per input	≤ 3.1 kW per input	per input ≤ 5.5 kW @ 0-500 m ≤ 4.8 kW @ 1400 m ≤ 4.3 kW @ 2100 m ≤ 3.8 kW @ 2800 m ≤ 3.2 kW @ 3600 m	
Tuning instruction	AS6019	AS8042	AS6019	AS8181
Insertion loss & mask filtering (alternative tuning on request)	f ₀ ≤ 0.65 dB	f ₀ ≤ 0.7 dB	f ₀ ≤ 0.65 dB	f ₀ ≤ 0.7 dB
	f ₀ ± 0.77 ≤ 1.3 dB	f ₀ ± 0.77 ≤ 1.3 dB	f ₀ ± 0.77 ≤ 1.3 dB	f ₀ ± 0.77 ≤ 1.5 dB
	f ₀ ± 0.97 ≥ 12 dB	f ₀ ± 0.97 ≥ 15 dB	f ₀ ± 0.97 ≥ 12 dB	f ₀ ± 0.97 ≥ 20 dB
	f ₀ ± 1.15 ≥ 30 dB	f ₀ ± 1.15 ≥ 30 dB	f ₀ ± 1.15 ≥ 30 dB	f ₀ ± 1.15 ≥ 30 dB
	f ₀ ± 1.75 ≥ 40 dB	f ₀ ± 1.75 ≥ 50 dB	f ₀ ± 1.75 ≥ 40 dB	f ₀ ± 1.75 ≥ 50 dB
	f ₀ ± 2.2 ≥ 55 dB	f ₀ ± 2.2 ≥ 65 dB	f ₀ ± 2.2 ≥ 55 dB	f ₀ ± 2.2 ≥ 65 dB
f ₀ ± 3.0 ≥ 55 dB	f ₀ ± 3.0 ≥ 65 dB	f ₀ ± 3.0 ≥ 55 dB	f ₀ ± 3.0 ≥ 65 dB	
Group delay variation	Δτ ≤ 1000 ns	Δτ ≤ 1200 ns	Δτ ≤ 1000 ns	Δτ ≤ 1200 ns
Output	1 5/8" EIA			
Isolation between inputs	≥ 35 dB			
VSWR	≤ 1.2			
Dimensions (L x W x H) mm	900 x 520 x 1465	1100 x 520 x 1465	900 x 520 x 1465	1100 x 520 x 1465
Weight	≈ 190 kg	≈ 235 kg	≈ 195 kg	≈ 240 kg
Environmental conditions	For limitations see „Environmental Conditions for Broadcast Products“.			

Band 3 DAB CIB Combiners

- Compact design
- For 1.54 MHz block width
- Integrated mask filters for DAB and T-DMB
- Adjacent block operation
- Temperature compensated
- Filters with cross coupling (notch function)

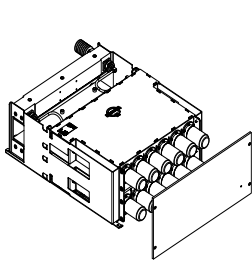
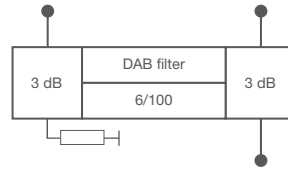

BN 576804

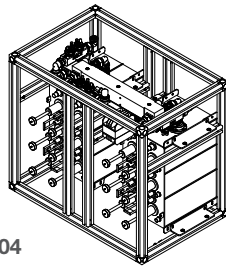

BN 574929

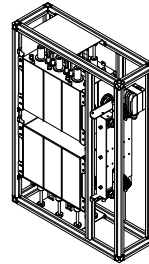

BN 574969

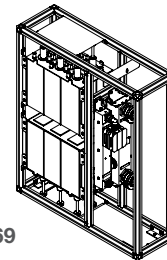

BN 574997

Multi Channel Combiners

Part Number	BN 576804 19" Design	BN 574929 19" Design	BN 574969 CCS Design	BN 574997 CCS Design
Frequency range	170 - 240 MHz			
Block spacing	≥ 0			
Narrowband input	7-16 female			
Filter type integrated cavities/size	6/70 ≡ BN 617129		6/100 ≡ BN 617116	
Temperature stability	≤ 1 kHz / K		≤ 1 kHz / K	
Harmonics attenuation	≥ 50 dB for f ≤ 500 MHz		≥ 50 dB for f ≤ 500 MHz	
DAB and T-DMB mask filtering	DAB / T-DMB @ 1.54 MHz ($\hat{U}/U_{rms}=13$ dB)			
Average input power	≤ 600 W		≤ 1.2 kW	
Tuning instruction	AS6547		AS6033	
Insertion loss & mask filtering (alternative tuning on request)	f_0 ≤ 1.5 dB $f_0 \pm 0.77$ ≤ 3.6 dB $f_0 \pm 0.97$ ≥ 15 dB $f_0 \pm 1.75$ ≥ 45 dB $f_0 \pm 2.2$ ≥ 50 dB $f_0 \pm 3.0$ ≥ 50 dB		f_0 ≤ 1.0 dB $f_0 \pm 0.77$ ≤ 2.3 dB $f_0 \pm 0.97$ ≥ 15 dB $f_0 \pm 1.75$ ≥ 45 dB $f_0 \pm 2.2$ ≥ 53 dB $f_0 \pm 3.0$ ≥ 53 dB	
Group delay variation	$\Delta\tau \leq 1200$ ns			
Wideband input	7-16 female		1 5/8" EIA	
Average input power	≤ 1.5 kW	≤ 3 kW		≤ 8 kW
	Attention: The power at the wideband input must be reduced by 50 % of the power fed into the narrowband input.			
Mask filtering	No			
Insertion loss	≤ 0.1 dB (non adjacent)			
Output	7-16 female		1 5/8" EIA	
Peak output voltage	≤ 2.8 kV	≤ 3.2 kV		≤ 7.8 kV
Isolation between inputs	≥ 35 dB			
VSWR	≤ 1.1			
Dimensions (L x W x H) mm	675 x 448 x 200	690 x 448 x 600	660 x 220 x 943	800 x 260 x 943
Weight	≈ 46 kg	≈ 70 kg		
Environmental conditions	For limitations see „Environmental Conditions for Broadcast Products“.			

Band 3 DAB CIB Combiners

- **CCS** compact design
- For 1.54 MHz block width
- Integrated mask filters for DAB and T-DMB
- Adjacent block operation
- Temperature compensated
- Filters without cross coupling (notch function)

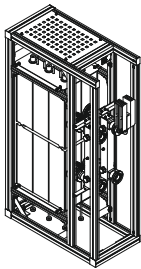
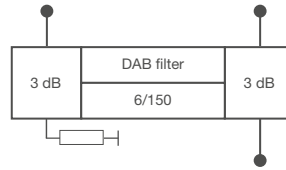

BN 574994

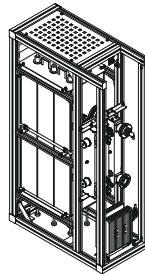

BN 574996

Part Number	BN 574994	BN 574996
Frequency range	170 - 240 MHz	
Block spacing	≥ 0	
Narrowband input	1 5/8" EIA	
Filter type integrated cavities/size	6/150 ≡ BN 617171	
Temperature stability	≤ 1 kHz / K	
Harmonics attenuation	≥ 50 dB for f ≤ 500 MHz	
DAB and T-DMB mask filtering	DAB / T-DMB @ 1.54 MHz ($\dot{U}/U_{rms}=13$ dB)	
Average input power	≤ 3 kW	
Tuning instruction	AS6010	
Insertion loss & mask filtering (alternative tuning on request)	$f_0 \leq 1.0$ dB $f_0 \pm 0.77 \leq 1.6$ dB $f_0 \pm 0.97 \geq 8.0$ dB $f_0 \pm 1.75 \geq 43$ dB $f_0 \pm 2.2 \geq 53$ dB $f_0 \pm 3.0 \geq 73$ dB	
Group delay variation	$\Delta\tau \leq 700$ ns	
Wideband input	1 5/8" EIA	3 1/8" EIA male
Average input power	≤ 14 kW	≤ 30 kW
	Attention: The power at the wideband input must be reduced by 50 % of the power fed into the narrowband input.	
Mask filtering	No	
Insertion loss	≤ 0.1 dB (non adjacent)	
Output	1 5/8" EIA	3 1/8" EIA male
Peak output voltage	≤ 7.7 kV	≤ 12.7 kV
Average output power	≤ 13.5 kW	–
Isolation between inputs	≥ 35 dB	
VSWR	≤ 1.1	
Dimensions (L x W x H) mm	800 x 390 x 1420	
Weight	≈ 120 kg	≈ 130 kg
Environmental conditions	For limitations see „Environmental Conditions for Broadcast Products“.	

Band 3 DAB CIB Combiners

- **CCS** compact design
- For 1.54 MHz block width
- Integrated mask filters for DAB and T-DMB
- Adjacent block operation
- Temperature compensated
- Filters with cross coupling (notch function)

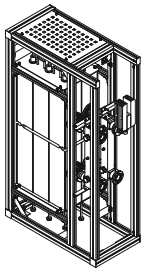
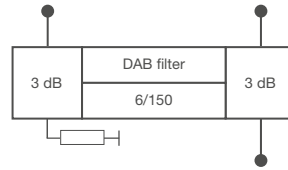

BN 574918

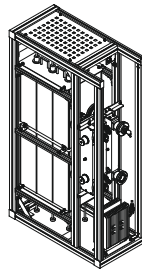

BN 574916

Multi Channel Combiners

Part Number	BN 574918	BN 574916
Frequency range	170 - 240 MHz	
Block spacing	≥ 0	
Narrowband input	1 5/8" EIA	
Filter type integrated cavities/size	6/150 ≡ BN 617144	
Temperature stability	≤ 1 kHz / K	
Harmonics attenuation	≥ 50 dB for f ≤ 500 MHz	
DAB and T-DMB mask filtering	DAB / T-DMB @ 1.54 MHz ($\dot{U}/U_{rms}=13$ dB)	
Average input power	≤ 3.2 kW	
Tuning instruction	AS6137	AS6149
Insertion loss & mask filtering (alternative tuning on request)	f_0 ≤ 0.75 dB $f_0 \pm 0.77$ ≤ 1.6 dB $f_0 \pm 0.97$ ≥ 15 dB $f_0 \pm 1.75$ ≥ 45 dB $f_0 \pm 2.2$ ≥ 58 dB $f_0 \pm 3.0$ ≥ 52 dB	f_0 ≤ 0.65 dB $f_0 \pm 0.77$ ≤ 0.90 dB $f_0 \pm 0.97$ n.d. $f_0 \pm 1.75$ ≥ 15 dB $f_0 \pm 2.2$ ≥ 40 dB $f_0 \pm 3.0$ ≥ 50 dB
Group delay variation	$\Delta\tau \leq 1000$ ns	$\Delta\tau \leq 400$ ns
Wideband input	1 5/8" EIA	3 1/8" EIA male
Average input power	≤ 14 kW	≤ 30 kW
	Attention: The power at the wideband input must be reduced by 50 % of the power fed into the narrowband input.	
Mask filtering	No	
Insertion loss	≤ 0.1 dB (non adjacent)	
Output	1 5/8" EIA	3 1/8" EIA male
Peak output voltage	≤ 7.7 kV	≤ 12.7 kV
Average output power	≤ 13.5 kW	-
Isolation between inputs	≥ 35 dB	
VSWR	≤ 1.1	
Dimensions (L x W x H) mm	800 x 390 x 1420	
Weight	≈ 120 kg	≈ 130 kg
Environmental conditions	For limitations see „Environmental Conditions for Broadcast Products“.	

Band 3 DAB CIB Combiners

- **CCS** compact design
- For 1.54 MHz block width
- Integrated mask filters for DAB and T-DMB
- Adjacent block operation
- Temperature compensated
- Filters with cross coupling (notch function)

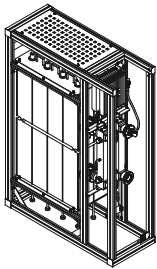
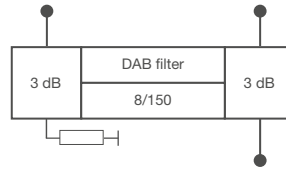

BN 574919



BN 574925

Part Number	BN 574919	BN 574925
Frequency range	170 - 240 MHz	
Block spacing	≥ 0	
Narrowband input	1 5/8" EIA	
Filter type integrated cavities/size	8/150 ≡ BN 617183	
Temperature stability	≤ 1 kHz / K	
Harmonics attenuation	≥ 50 dB for f ≤ 500 MHz	
DAB and T-DMB mask filtering	DAB / T-DMB @ 1.54 MHz ($\dot{U}/U_{rms}=13$ dB)	
Average input power	≤ 3.2 kW	
Tuning instruction	AS8027	
Insertion loss & mask filtering (alternative tuning on request)	$f_0 \leq 1.3$ dB $f_0 \pm 0.77 \leq 2.2$ dB $f_0 \pm 0.97 \geq 15$ dB $f_0 \pm 1.75 \geq 45$ dB $f_0 \pm 2.2 \geq 65$ dB $f_0 \pm 3.0 \geq 80$ dB	
Group delay variation	$\Delta\tau \leq 1000$ ns	
Wideband input	1 5/8" EIA	3 1/8" EIA male
Average input power	≤ 14 kW	≤ 30 kW
	Attention: The power at the wideband input must be reduced by 50 % of the power fed into the narrowband input.	
Mask filtering	No	
Insertion loss	≤ 0.1 dB (non adjacent)	
Output	1 5/8" EIA	3 1/8" EIA male
Peak output voltage	≤ 7.7 kV	≤ 12.7 kV
Average output power	≤ 13.5 kW	–
Isolation between inputs	≥ 35 dB	
VSWR	≤ 1.1	
Dimensions (L x W x H) mm	1000 x 390 x 1420	
Weight	≈ 150 kg	≈ 170 kg
Environmental conditions	For limitations see „Environmental Conditions for Broadcast Products“.	

Band 3 DAB CIB Combiners

- Compact design
- For 1.54 MHz block width
- Integrated mask filters for DAB and T-DMB
- Adjacent block operation
- Temperature compensated
- Filters with cross coupling (notch function)

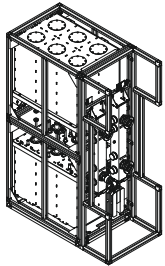
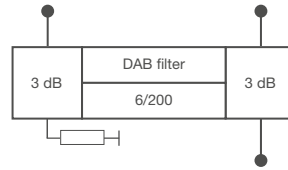

BN 576810

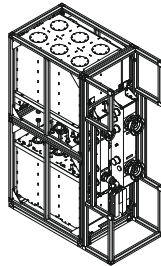

BN 576811

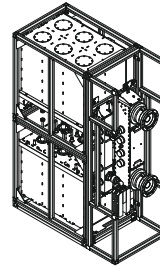

BN 576812

Multi Channel Combiners

Part Number Cooling	BN 576810 Natural cooling	BN 576811 Natural cooling	BN 576812 Natural cooling
Frequency range	174 - 240 MHz		
Block spacing	≥ 0		
Narrowband input	1 5/8" EIA		
Filter type integrated cavities/size	6/200 ≡ BN 617166		
Temperature stability	≤ 1 kHz / K		
Harmonics attenuation	≥ 50 dB for f < 500 MHz		
DAB and T-DMB mask filtering	DAB / T-DMB @ 1.54 MHz ($\dot{U}/U_{rms}=13$ dB)		
Average input power	≤ 6.0 kW		
Tuning instruction	AS6087		
Insertion loss & mask filtering (alternative tuning on request)	$f_0 \leq 0.6$ dB $f_0 \pm 0.77 \leq 1.4$ dB $f_0 \pm 0.97 \geq 15$ dB $f_0 \pm 1.15 \geq$ n.d. $f_0 \pm 1.75 \geq 45$ dB $f_0 \pm 2.20 \geq 50$ dB $f_0 \pm 3.00 \geq 50$ dB		
Group delay variation	$\Delta\tau \leq 1200$ ns		
Wideband input	1 5/8" EIA	3 1/8" EIA	4 1/2" EIA
Average input power	≤ 14 kW	≤ 30 kW	≤ 60 kW
	Attention: The power at the wideband input must be reduced by 50 % of the power fed into the narrowband input.		
Mask filtering	No		
Insertion loss	≤ 0.1 dB (non adjacent)		
Output	1 5/8" EIA	3 1/8" EIA	4 1/2" EIA
Peak output voltage	≤ 7.7 kV	≤ 12.7 kV	≤ 15.5 kV
Average output power	≤ 13.5 kW	-	-
Isolation between inputs	≥ 35 dB		
VSWR	≤ 1.1		
Dimensions (L x W x H) mm	1080 x 520 x 1420 + 50 mm bottom frame		
Weight	≈ 230 kg		
Environmental conditions	For limitations see „Environmental Conditions for Broadcast Products“.		

Band 3 DAB CIB Combiners

- Compact design
- For 1.54 MHz block width
- Integrated mask filters for DAB and T-DMB
- Adjacent block operation
- Temperature compensated
- Filters with cross coupling (notch function)

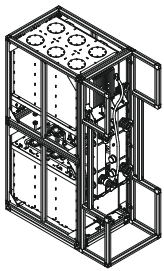
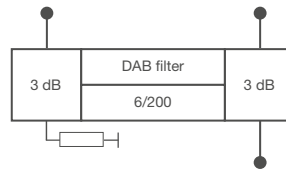

BN 576813

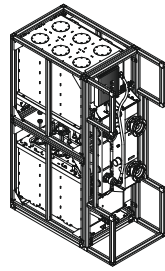

BN 576814

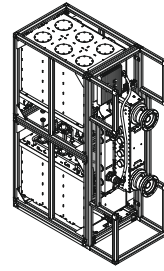

BN 576815

Part Number Cooling	BN 576813 Liquid cooling	BN 576814 Liquid cooling	BN 576815 Liquid cooling
Frequency range	174 - 240 MHz		
Block spacing	≥ 0		
Narrowband input	1 5/8" EIA		
Filter type integrated cavities/size	6/200 ≡ BN 617166		
Temperature stability	≤ 1 kHz / K		
Harmonics attenuation	≥ 50 dB for f < 500 MHz		
DAB and T-DMB mask filtering	DAB / T-DMB @ 1.54 MHz ($\dot{U}/U_{rms}=13$ dB)		
Average input power	≤ 11.0 kW @ 0 – 500m		
Tuning instruction	AS6087		
Insertion loss & mask filtering (alternative tuning on request)	$f_0 \leq 0.6$ dB $f_0 \pm 0.77 \leq 1.4$ dB $f_0 \pm 0.97 \geq 15$ dB $f_0 \pm 1.15 \geq$ n.d. $f_0 \pm 1.75 \geq 45$ dB $f_0 \pm 2.20 \geq 50$ dB $f_0 \pm 3.00 \geq 50$ dB		
Group delay variation	$\Delta\tau \leq 1200$ ns		
Wideband input	1 5/8" EIA	3 1/8" EIA	4 1/2" EIA
Average input power	≤ 14 kW	≤ 30 kW	≤ 60 kW
	Attention: The power at the wideband input must be reduced by 50 % of the power fed into the narrowband input.		
Mask filtering	No		
Insertion loss	≤ 0.1 dB (non adjacent)		
Output	1 5/8" EIA	3 1/8" EIA	4 1/2" EIA
Peak output voltage	≤ 7.7 kV	≤ 12.7 kV	≤ 15.5 kV
Average output power	≤ 13.5 kW	-	-
Isolation between inputs	≥ 35 dB		
VSWR	≤ 1.1		
Dimensions (L x W x H) mm	1080 x 520 x 1420 + 50 mm bottom frame		
Weight	≈ 235 kg		
Liquid cooling interface	Stainless steel tube 12 x 1 mm ending horizontally at the bottom frame		
Environmental conditions	For limitations see „Environmental Conditions for Broadcast Products“.		

Band 3 DAB CIB Combiners

- Compact design
- For 1.54 MHz block width
- Integrated mask filters for DAB and T-DMB
- Adjacent block operation
- Temperature compensated
- Filters with cross coupling (notch function)
- High power version

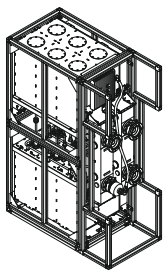
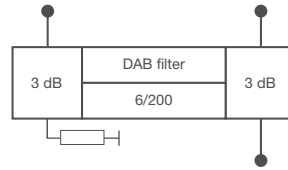

BN 576816

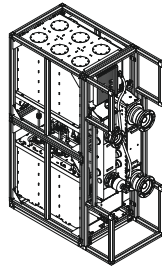

BN 576817

Multi Channel Combiners

Part Number Cooling	BN 576816 Liquid cooling	BN 576817 Liquid cooling
Frequency range	174 - 240 MHz	
Block spacing	≥ 0	
Narrowband input	3 1/8" EIA	
Filter type integrated cavities/size	6/200 ≡ BN 617165	
Temperature stability	≤ 1 kHz / K	
Harmonics attenuation	≥ 50 dB for f < 500 MHz	
DAB and T-DMB mask filtering	DAB / T-DMB @ 1.54 MHz ($\dot{U}/U_{rms}=13$ dB)	
Average input power	≤ 16 kW @ 0 – 500m	
Tuning instruction	AS6087	
Insertion loss & mask filtering (alternative tuning on request)	$f_0 \leq 0.6$ dB $f_0 \pm 0.77 \leq 1.4$ dB $f_0 \pm 0.97 \geq 15$ dB $f_0 \pm 1.75 \geq 45$ dB $f_0 \pm 2.20 \geq 50$ dB $f_0 \pm 3.00 \geq 50$ dB	
Group delay variation	$\Delta\tau \leq 1200$ ns	
Wideband input	3 1/8" EIA	4 1/2" EIA
Average input power	≤ 30 kW	≤ 60 kW
	Attention: The power at the wideband input must be reduced by 50 % of the power fed into the narrowband input.	
Mask filtering	No	
Insertion loss	≤ 0.1 dB (non adjacent)	
Output	3 1/8" EIA	4 1/2" EIA
Peak output voltage	≤ 12.7 kV	≤ 15.5 kV
Isolation between inputs	≥ 35 dB	
VSWR	≤ 1.1	
Dimensions (L x W x H) mm	1000 x 520 x 1420 + 50 mm bottom frame	
Weight	≈ 250 kg	
Liquid cooling interface	Stainless steel tube 12 x 1 mm ending horizontally at the bottom frame	
Environmental conditions	For limitations see „Environmental Conditions for Broadcast Products“.	

Band 3 DAB CIB Combiners

- Compact design
- For 1.54 MHz block width
- Integrated mask filters for DAB and T-DMB
- Adjacent block operation
- Temperature compensated
- Filters with cross coupling (notch function)

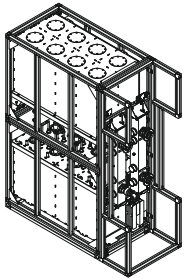
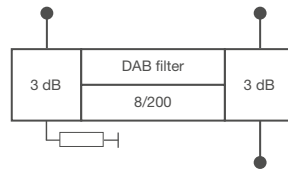

BN 576820

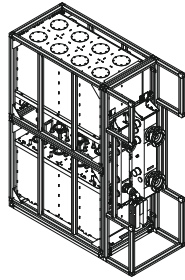

BN 576821

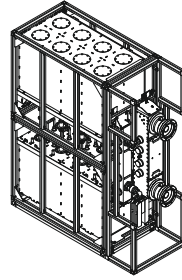

BN 576822

Part Number Cooling	BN 576820 Natural cooling	BN 576821 Natural cooling	BN 576822 Natural cooling
Frequency range		174 - 240 MHz	
Block spacing		≥ 0	
Narrowband input		1 5/8" EIA	
Filter type integrated cavities/size		8/200 ≡ BN 617168	
Temperature stability		≤ 1 kHz / K	
Harmonics attenuation		≥ 50 dB for f < 500 MHz	
DAB and T-DMB mask filtering		DAB / T-DMB @ 1.54 MHz (\dot{U}/U_{rms} =13 dB)	
Average input power		≤ 6.0 kW	
Tuning instruction		AS8181	
Insertion loss & mask filtering (alternative tuning on request)		$f_0 \leq 0.7$ dB $f_0 \pm 0.77 \leq 1.4$ dB $f_0 \pm 0.97 \geq 20$ dB $f_0 \pm 1.15 \geq 30$ dB $f_0 \pm 1.75 \geq 50$ dB $f_0 \pm 2.20 \geq 65$ dB $f_0 \pm 3.00 \geq 65$ dB	
Group delay variation		$\Delta\tau \leq 1200$ ns	
Wideband input	1 5/8" EIA	3 1/8" EIA	4 1/2" EIA
Average input power	≤ 14 kW	≤ 30 kW	≤ 60 kW
	Attention: The power at the wideband input must be reduced by 50 % of the power fed into the narrowband input.		
Mask filtering		No	
Insertion loss		≤ 0.1 dB (non adjacent)	
Output	1 5/8" EIA	3 1/8" EIA	4 1/2" EIA
Peak output voltage	≤ 7.7 kV	≤ 12.7 kV	≤ 15.5 kV
Average output power	≤ 13.5 kW	-	-
Isolation between inputs		≥ 35 dB	
VSWR		≤ 1.1	
Dimensions (L x W x H) mm	1200 x 520 x 1420 + 50 mm bottom frame		
Weight	≈ 280 kg		
Environmental conditions	For limitations see „Environmental Conditions for Broadcast Products“.		

Band 3 DAB CIB Combiners

- Compact design
- For 1.54 MHz block width
- Integrated mask filters for DAB and T-DMB
- Adjacent block operation
- Temperature compensated
- Filters with cross coupling (notch function)

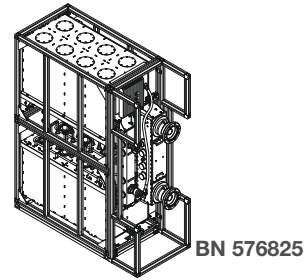
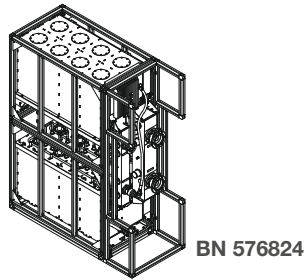
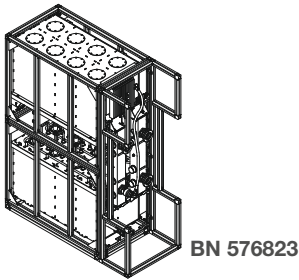
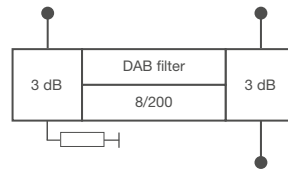

Multi Channel Combiners

Part Number Cooling	BN 576823 Liquid cooling	BN 576824 Liquid cooling	BN 576825 Liquid cooling
Frequency range	174 - 240 MHz		
Block spacing	≥ 0		
Narrowband input	1 5/8" EIA		
Filter type integrated cavities/size	8/200 ≡ BN 617168		
Temperature stability	≤ 1 kHz / K		
Harmonics attenuation	≥ 50 dB for f < 500 MHz		
DAB and T-DMB mask filtering	DAB / T-DMB @ 1.54 MHz ($\dot{U}/U_{rms}=13$ dB)		
Average input power	≤ 11.0 kW @ 0 – 500m		
Tuning instruction	AS8180		
Insertion loss & mask filtering (alternative tuning on request)	$f_0 \leq 0.7$ dB $f_0 \pm 0.77 \leq 1.45$ dB $f_0 \pm 0.97 \geq 28$ dB $f_0 \pm 1.15 \geq$ n.d. $f_0 \pm 1.75 \geq 61$ dB $f_0 \pm 2.20 \geq 69$ dB $f_0 \pm 3.00 \geq 70$ dB		
Group delay variation	$\Delta\tau \leq 1200$ ns		
Wideband input	1 5/8" EIA	3 1/8" EIA	4 1/2" EIA
Average input power	≤ 14 kW	≤ 30 kW	≤ 60 kW
	Attention: The power at the wideband input must be reduced by 50 % of the power fed into the narrowband input.		
Mask filtering	No		
Insertion loss	≤ 0.1 dB (non adjacent)		
Output	1 5/8" EIA	3 1/8" EIA	4 1/2" EIA
Peak output voltage	≤ 7.7 kV	≤ 12.7 kV	≤ 15.5 kV
Average output power	≤ 13.5 kW	–	–
Isolation between inputs	≥ 35 dB		
VSWR	≤ 1.1		
Dimensions (L x W x H) mm	1200 x 520 x 1420 + 50 mm bottom frame		
Weight	≈ 285 kg		
Liquid cooling interface	Stainless steel tube 12 x 1 mm ending horizontally at the bottom frame		
Environmental conditions	For limitations see „Environmental Conditions for Broadcast Products“.		

Band 3 DAB CIB Combiners

- Compact design
- For 1.54 MHz block width
- Integrated mask filters for DAB and T-DMB
- Adjacent block operation
- Temperature compensated
- Filters with cross coupling (notch function)
- High power version

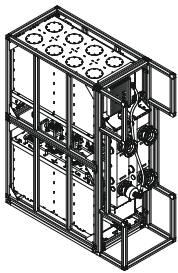
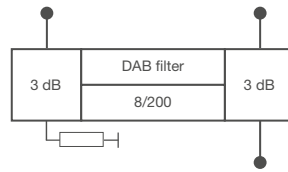

BN 576826

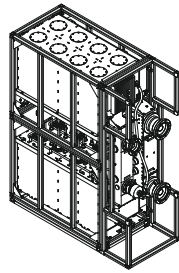

BN 576827

Part Number Cooling	BN 576826 Liquid cooling	BN 576827 Liquid cooling
Frequency range	174 - 240 MHz	
Block spacing	≥ 0	
Narrowband input	3 1/8" EIA	
Filter type integrated cavities/size	8/200 ≡ BN 617167	
Temperature stability	≤ 1 kHz / K	
Harmonics attenuation	≥ 50 dB for f < 500 MHz	
DAB and T-DMB mask filtering	DAB / T-DMB @ 1.54 MHz ($\dot{U}/U_{rms}=13$ dB)	
Average input power	≤ 16 kW @ 0 – 500m	
Tuning instruction	AS8180	
Insertion loss & mask filtering (alternative tuning on request)	$f_0 \leq 0.7$ dB $f_0 \pm 0.77 \leq 1.45$ dB $f_0 \pm 0.97 \geq 28$ dB $f_0 \pm 1.75 \geq 61$ dB $f_0 \pm 2.20 \geq 69$ dB $f_0 \pm 3.00 \geq 70$ dB	
Group delay variation	$\Delta\tau \leq 1300$ ns	
Wideband input	3 1/8" EIA	4 1/2" EIA
Average input power	≤ 30 kW	≤ 60 kW
	Attention: The power at the wideband input must be reduced by 50 % of the power fed into the narrowband input.	
Mask filtering	No	
Insertion loss	≤ 0.1 dB (non adjacent)	
Output	3 1/8" EIA	4 1/2" EIA
Peak output voltage	≤ 12.7 kV	≤ 15.5 kV
Isolation between inputs	≥ 35 dB	
VSWR	≤ 1.1	
Dimensions (L x W x H) mm	1200 x 520 x 1420 + 50 mm bottom frame	
Weight	≈ 300 kg	
Liquid cooling interface	Stainless steel tube 12 x 1 mm ending horizontally at the bottom frame	
Environmental conditions	For limitations see „Environmental Conditions for Broadcast Products“.	

Band 3 DAB CIB Combiners

- Compact design
- For 1.54 MHz block width
- Integrated mask filters for DAB and T-DMB
- Adjacent block operation
- Temperature compensated
- Filters with cross coupling (notch function)

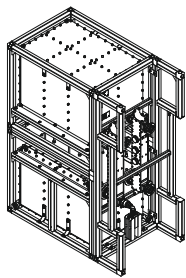
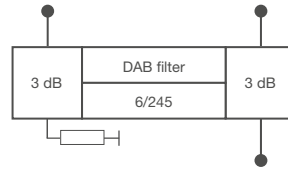

BN 576870

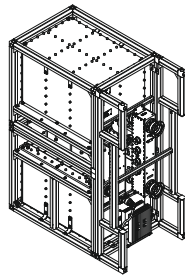

BN 576871

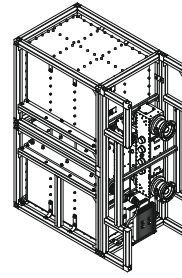

BN 576872

Multi Channel Combiners

Part Number	BN 576870	BN 576871	BN 576872
Frequency range	174 - 240 MHz		
Block spacing	≥ 0		
Narrowband input	1 5/8" EIA		
Filter type integrated cavities/size	6/245 ≡ BN 617146		
Temperature stability	≤ 1 kHz / K		
Harmonics attenuation	≥ 50 dB for f < 460 MHz ≥ 40 dB for 460 - 480 MHz		
DAB and T-DMB mask filtering	DAB / T-DMB @ 1.54 MHz (Ü/U _{rms} =13 dB)		
Average input power	≤ 10 kW		
Tuning instruction	AS6525		
Insertion loss & mask filtering (alternative tuning on request)	$f_0 \leq 0.55$ dB $f_0 \pm 0.77 \leq 1.35$ dB $f_0 \pm 0.97 \leq 15$ dB $f_0 \pm 1.75 \leq 46$ dB $f_0 \pm 2.20 \leq 59$ dB $f_0 \pm 3.00 \leq 59$ dB		
Group delay variation	$\Delta\tau \leq 1300$ ns		
Wideband input	1 5/8" EIA	3 1/8" EIA	4 1/2" EIA
Average input power	≤ 14 kW	≤ 30 kW	≤ 60 kW
	Attention: The power at the wideband input must be reduced by 50 % of the power fed into the narrowband input.		
Mask filtering	No		
Insertion loss	≤ 0.1 dB (non adjacent)		
Output	1 5/8" EIA	3 1/8" EIA	4 1/2" EIA
Peak output voltage	≤ 7.7 kV	≤ 12.7 kV	≤ 15.5 kV
Average output power	≤ 13.5 kW	-	-
Isolation between inputs	≥ 35 dB		
VSWR	≤ 1.1		
Dimensions (L x W x H) mm	1200 x 670 x 1530		
Weight	≈ 280 kg		
Environmental conditions	For limitations see „Environmental Conditions for Broadcast Products“.		

Band 3 DAB CIB Combiners

- Compact design
- For 1.54 MHz block width
- Integrated mask filters for DAB and T-DMB
- Adjacent block operation
- Temperature compensated
- Filters with cross coupling (notch function)

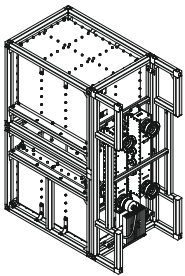
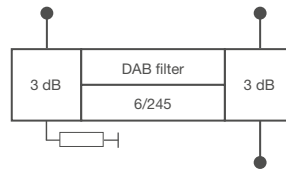

BN 576873

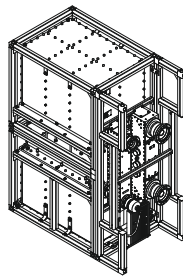

BN 576874

Part Number	BN 576873 Liquid cooling	BN 576874 Liquid cooling
Frequency range	174 - 240 MHz	
Block spacing	≥ 0	
Narrowband input	3 1/8" EIA	
Filter type integrated cavities/size	6/245 ≡ BN 617146	
Temperature stability	≤ 1 kHz / K	
Harmonics attenuation	≥ 50 dB for f < 460 MHz ≥ 40 dB for 460 - 480 MHz	
DAB and T-DMB mask filtering	DAB / T-DMB @ 1.54 MHz ($\dot{U}/U_{rms}=13$ dB)	
Average input power	≤ 20 kW	
Tuning instruction	AS6525	
Insertion loss & mask filtering (alternative tuning on request)	$f_0 \leq 0.55$ dB $f_0 \pm 0.77 \leq 1.35$ dB $f_0 \pm 0.97 \leq 15$ dB $f_0 \pm 1.75 \leq 46$ dB $f_0 \pm 2.20 \leq 59$ dB $f_0 \pm 3.00 \leq 59$ dB	
Group delay variation	$\Delta\tau \leq 1300$ ns	
Wideband input	3 1/8" EIA	4 1/2" EIA
Average input power	≤ 30 kW	≤ 60 kW
	Attention: The power at the wideband input must be reduced by 50 % of the power fed into the narrowband input.	
Mask filtering	No	
Insertion loss	≤ 0.1 dB (non adjacent)	
Output	3 1/8" EIA	4 1/2" EIA
Peak output voltage	≤ 12.7 kV	≤ 15.5 kV
Isolation between inputs	≥ 35 dB	
VSWR	≤ 1.1	
Dimensions (L x W x H) mm	1200 x 670 x 1530	
Weight	≈ 280 kg	
Environmental conditions	For limitations see „Environmental Conditions for Broadcast Products“.	

Band 3 DAB CIB Combiners

- Compact design
- For 1.54 MHz block width
- Integrated mask filters for DAB and T-DMB
- Adjacent block operation
- Temperature compensated
- Filters with cross coupling (notch function)

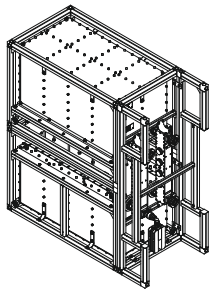
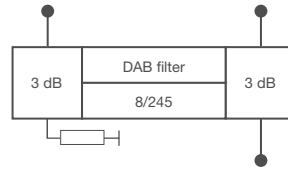

BN 576880

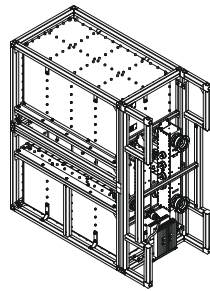

BN 576881

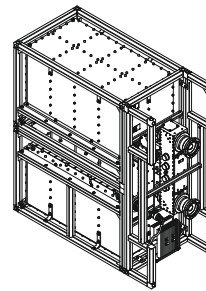

BN 576882

Multi Channel
Combiners

Part Number	BN 576880 Natural cooling	BN 576881 Natural cooling	BN 576882 Natural cooling
Frequency range	174 - 240 MHz		
Block spacing	≥ 0		
Narrowband input	1 5/8" EIA		
Filter type integrated cavities/size	8/245 ≡ BN 617148		
Temperature stability	≤ 1 kHz / K		
Harmonics attenuation	≥ 50 dB for f < 460 MHz ≥ 40 dB for 460 - 480 MHz		
DAB and T-DMB mask filtering	DAB / T-DMB @ 1.54 MHz (Ü/U _{rms} =13 dB)		
Average input power	≤ 10 kW		
Tuning instruction	AS8164		
Insertion loss & mask filtering (alternative tuning on request)	$f_0 \leq 0.65$ dB $f_0 \pm 0.77 \leq 1.45$ dB $f_0 \pm 0.97 \leq 8$ dB $f_0 \pm 1.75 \leq 50$ dB $f_0 \pm 2.20 \leq 70$ dB $f_0 \pm 3.00 \leq 70$ dB		
Group delay variation	$\Delta\tau \leq 1200$ ns		
Wideband input	1 5/8" EIA	3 1/8" EIA	4 1/2" EIA
Average input power	≤ 14 kW	≤ 30 kW	≤ 60 kW
	Attention: The power at the wideband input must be reduced by 50 % of the power fed into the narrowband input.		
Mask filtering	No		
Insertion loss	≤ 0.1 dB (non adjacent)		
Output	1 5/8" EIA	3 1/8" EIA	4 1/2" EIA
Peak output voltage	≤ 7.7 kV	≤ 12.7 kV	≤ 15.5 kV
Average output power	≤ 13.5 kW	-	-
Isolation between inputs	≥ 35 dB		
VSWR	≤ 1.1		
Dimensions (L x W x H) mm	1455 x 670 x 1530		
Weight	≈ 360 kg		
Environmental conditions	For limitations see „Environmental Conditions for Broadcast Products“.		

Band 3 DAB CIB Combiners

- Compact design
- For 1.54 MHz block width
- Integrated mask filters for DAB and T-DMB
- Adjacent block operation
- Temperature compensated
- Filters with cross coupling (notch function)

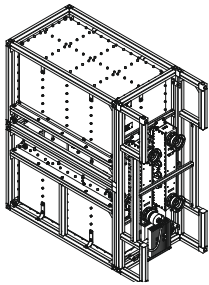
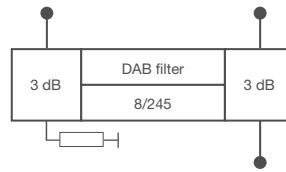

BN 576883

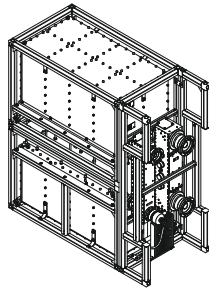

BN 576884

Part Number	BN 576883 Liquid cooling	BN 576884 Liquid cooling
Frequency range	174 - 240 MHz	
Block spacing	≥ 0	
Narrowband input	3 1/8" EIA	
Filter type integrated cavities/size	8/245 ≡ BN 617148	
Temperature stability	≤ 1 kHz / K	
Harmonics attenuation	≥ 50 dB for f < 460 MHz ≥ 40 dB for 460 - 480 MHz	
DAB and T-DMB mask filtering	DAB / T-DMB @ 1.54 MHz (\dot{U}/U_{rms} =13 dB)	
Average input power	≤ 20 kW	
Tuning instruction	AS8164	
Insertion loss & mask filtering (alternative tuning on request)	$f_0 \leq 0.65$ dB $f_0 \pm 0.77 \leq 1.45$ dB $f_0 \pm 0.97 \leq 18$ dB $f_0 \pm 1.75 \leq 50$ dB $f_0 \pm 2.20 \leq 70$ dB $f_0 \pm 3.00 \leq 70$ dB	
Group delay variation	$\Delta\tau \leq 1200$ ns	
Wideband input	3 1/8" EIA	4 1/2" EIA
Average input power	≤ 30 kW	≤ 60 kW
	Attention: The power at the wideband input must be reduced by 50 % of the power fed into the narrowband input.	
Mask filtering	No	
Insertion loss	≤ 0.1 dB (non adjacent)	
Output	3 1/8" EIA	4 1/2" EIA
Peak output voltage	≤ 12.7 kV	≤ 15.5 kV
Isolation between inputs	≥ 35 dB	
VSWR	≤ 1.1	
Dimensions (L x W x H) mm	1455 x 670 x 1530	
Weight	≈ 360 kg	
Environmental conditions	For limitations see „Environmental Conditions for Broadcast Products“.	

Band 3 DTV Starpoint Combiners

- Compact design as 19" slide-in unit
- For 6, 7 and 8 MHz channel bandwidth
- Integrated mask filters for DTV
- Temperature compensated
- Filters with cross coupling (notch function)
- Tuneable within the whole band 3

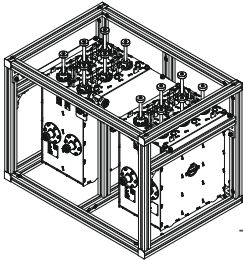
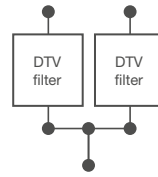

Typical design

Part Number	BN 574669		
Frequency range	174 - 230 MHz		
Block spacing	≥ 1		
Narrowband input	7-16 female		
Filter type integrated cavities/size	6/100 ≡ BN 617190		
Temperature stability	≤ 2 kHz / K		
Harmonics attenuation	≥ 50 dB for f ≤ 500 MHz		
Mask filtering	DVB-T @ 8 MHz ($\dot{U}/U_{rms}=13$ dB)	DVB-T @ 7 MHz ($\dot{U}/U_{rms}=13$ dB)	ATSC 1.0 @ 6 MHz ($\dot{U}/U_{rms}=11$ dB)
Average input power	≤ 1.1 kW	≤ 1.0 kW	≤ 900 W
Tuning instruction	AS6164	AS6162	AS6161
Insertion loss & mask filtering (alternative tuning on request)	$f_0 \leq 0.35$ dB $f_0 \pm 3.805 \leq 0.75$ dB $f_0 \pm 4.200 \geq 4.0$ dB $f_0 \pm 6.000 \geq 20$ dB $f_0 \pm 12.00 \geq 55$ dB	$f_0 \leq 0.35$ dB $f_0 \pm 3.35 \leq 0.80$ dB $f_0 \pm 3.50 \geq 1.2$ dB $f_0 \pm 3.65 \geq 4.0$ dB $f_0 \pm 5.00 \geq 20$ dB $f_0 \pm 12.0 \geq 55$ dB	$f_0 \leq 0.40$ dB $f_0 \pm 2.69 \leq 0.60$ dB $f_0 \pm 3.00 \geq 1.2$ dB $f_0 \pm 3.50 \geq 8.0$ dB $f_0 \pm 4.00 \geq 15$ dB $f_0 \pm 6.00 \geq 30$ dB $f_0 \pm 9.00 \geq 64$ dB
Group delay variation	$\Delta\tau \leq 350$ ns	$\Delta\tau \leq 350$ ns	$\Delta\tau \leq 220$ ns
Output	7-16 female		
Isolation between inputs	≥ 35 dB		
VSWR	≤ 1.2		
Dimensions (L x W x H) mm	689 x 448 x 510		
Weight	≈ 55 kg		
Environmental conditions	For limitations see „Environmental Conditions for Broadcast Products“.		

Band 3 DTV CIB Combiners

- Compact design
- For 6, 7 and 8 MHz channel bandwidth
- Integrated mask filters for DTV
- Adjacent channel operation
- Temperature compensated
- Filters with cross coupling (notch function)
- Tuneable within the whole band 3

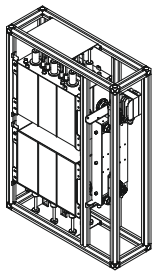
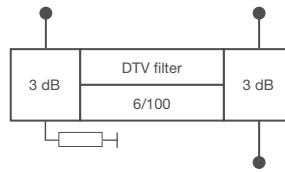

BN 576800

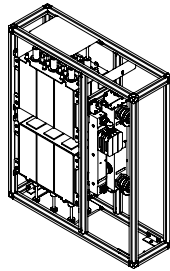

BN 576801

Part Number	BN 576800		BN 576801
Frequency range	174 - 230 MHz		
Block spacing	≥ 0		
Narrowband input	7-16 female		
Filter type integrated cavities/size	6/100 ≡ BN 617190		
Temperature stability	≤ 2 kHz / K		
Harmonics attenuation	≥ 50 dB for f ≤ 500 MHz		
Mask filtering	DVB-T @ 8 MHz ($\dot{U}/U_{rms}=13$ dB)	DVB-T @ 7 MHz ($\dot{U}/U_{rms}=13$ dB)	ATSC 1.0 @ 6 MHz ($\dot{U}/U_{rms}=11$ dB)
Average input power	≤ 2.2 kW	≤ 2.0 kW	≤ 1.8 kW
Tuning instruction	AS6164	AS6162	AS6161
Insertion loss & mask filtering (alternative tuning on request)	$f_0 \leq 0.35$ dB $f_0 \pm 3.805 \leq 0.75$ dB $f_0 \pm 4.20 \geq 4.0$ dB $f_0 \pm 6.00 \geq 20$ dB $f_0 \pm 12.0 \geq 55$ dB	$f_0 \leq 0.35$ dB $f_0 \pm 3.35 \leq 0.80$ dB $f_0 \pm 3.50 \geq 1.3$ dB $f_0 \pm 3.65 \geq 4.0$ dB $f_0 \pm 5.00 \geq 20$ dB $f_0 \pm 12.0 \geq 55$ dB	$f_0 \leq 0.40$ dB $f_0 \pm 2.69 \leq 0.60$ dB $f_0 \pm 3.00 \geq 1.2$ dB $f_0 \pm 3.50 \geq 8.0$ dB $f_0 \pm 4.00 \geq 15$ dB $f_0 \pm 6.00 \geq 30$ dB $f_0 \pm 9.00 \geq 64$ dB
Group delay variation	$\Delta\tau \leq 350$ ns	$\Delta\tau \leq 350$ ns	$\Delta\tau \leq 220$ ns
Wideband input	7-16 female		1 5/8" EIA
Average input power	≤ 3 kW		≤ 14 kW
	Attention: The power at the wideband input must be reduced by 50 % of the power fed into the narrowband input.		
DTV mask filtering	No		
Insertion loss	≤ 0.1 dB (non adjacent)		
Output	7-16 female		1 5/8" EIA
Peak output voltage	≤ 3.2 kV		≤ 7.7 kV
Average output power	≤ 3.8 kW		≤ 13.5 kW
Isolation between inputs	≥ 35 dB		
VSWR	≤ 1.1		
Dimensions (L x W x H) mm	700 x 310 x 1250		
Weight	≈ 65 kg		
Environmental conditions	For limitations see „Environmental Conditions for Broadcast Products“.		

Band 3 DTV CIB Combiners

- Compact design
- For 6, 7 and 8 MHz channel bandwidth
- Integrated mask filters for DTV
- Adjacent channel operation
- Temperature compensated
- Filters with cross coupling (notch function)
- Tuneable within the whole band 3

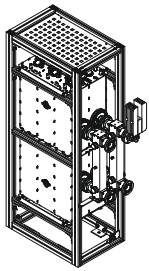
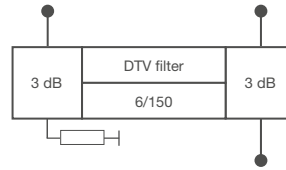

BN 574936

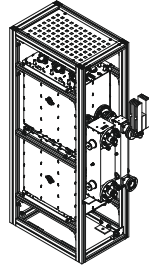

BN 574938

Multi Channel Combiners

Part Number	BN 574936	BN 574938
Frequency range	174 - 230 MHz	
Block spacing	≥ 0	
Narrowband input	1 5/8" EIA	
Filter type integrated cavities/size	6/150 ≡ BN 617126	
Temperature stability	≤ 2 kHz / K	
Mask filtering	DVB-T @ 7 MHz ($\dot{U}/U_{rms}=13$ dB)	ATSC 1.0 @ 6 MHz ($\dot{U}/U_{rms}=11$ dB)
Average input power	≤ 8 kW	≤ 7.2 kW
Tuning instruction	AS6044	AS6079
Insertion loss & mask filtering (alternative tuning on request)	f_0 ≤ 0.40 dB $f_0 \pm 3.35$ ≤ 0.70 dB $f_0 \pm 3.50$ ≥ 0.80 dB $f_0 \pm 3.65$ ≥ 2.0 dB $f_0 \pm 5.00$ ≥ 35 dB $f_0 \pm 12.0$ ≥ 55 dB	f_0 ≤ 0.45 dB $f_0 \pm 2.69$ ≤ 0.70 dB $f_0 \pm 3.00$ ≥ 1.4 dB $f_0 \pm 3.50$ ≥ 5.0 dB $f_0 \pm 4.00$ ≥ 11 dB $f_0 \pm 6.00$ ≥ 30 dB $f_0 \pm 9.00$ ≥ 65 dB
Group delay variation	$\Delta\tau$ ≤ 350 ns	$\Delta\tau$ ≤ 200 ns
Wideband input	1 5/8" EIA	3 1/8" EIA male
Average input power	≤ 14 kW	≤ 30 kW
	Attention: The power at the wideband input must be reduced by 50 % of the power fed into the narrowband input.	
DTV mask filtering	No	
Insertion loss	≤ 0.1 dB (non adjacent)	
Output	1 5/8" EIA	3 1/8" EIA male
Peak output voltage	≤ 7.7 kV	≤ 12.7 kV
Average output power	≤ 13.5 kW	-
Isolation between inputs	≥ 35 dB	
VSWR	≤ 1.1	
Dimensions (L x W x H) mm	≈ 852 x 390 x 1420	≈ 852 x 390 x 1420
Weight	≈ 120 kg	≈ 130 kg
Environmental conditions	For limitations see „Environmental Conditions for Broadcast Products“.	

Band 3 DTV CIB Combiners

- Compact design
- For 6, 7 and 8 MHz channel bandwidth
- Integrated mask filters for DTV
- Adjacent channel operation
- Temperature compensated
- Filters with cross coupling (notch function)
- Tuneable within the whole band 3

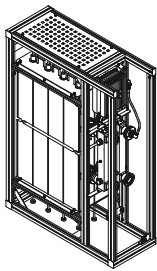
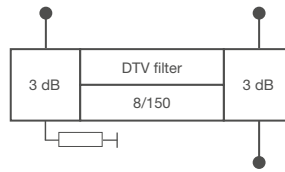

BN 574686



BN 574687

Part Number	BN 574686	BN 574687
Frequency range	174 - 230 MHz	
Block spacing	≥ 0	
Narrowband input	1 5/8" EIA	
Filter type integrated cavities/size	8/150 ≡ BN 617191	
Temperature stability	≤ 2 kHz / K	
Mask filtering	DVB-T @ 7 MHz ($\dot{U}/U_{rms}=13$ dB)	
Average input power	≤ 7 kW	
Tuning instruction	AS8049	
Insertion loss & mask filtering (alternative tuning on request)	f_0 ≤ 0.45 dB $f_0 \pm 3.35$ ≤ 0.95 dB $f_0 \pm 3.70$ ≥ 15 dB $f_0 \pm 5.25$ ≥ 30 dB $f_0 \pm 10.5$ ≥ 50 dB $f_0 \pm 11.75$ ≥ 55 dB	
Group delay variation	$\Delta\tau \leq 600$ ns	
Wideband input	1 5/8" EIA	3 1/8" EIA male
Average input power	≤ 14 kW	≤ 30 kW
	Attention: The power at the wideband input must be reduced by 50 % of the power fed into the narrowband input.	
DTV mask filtering	No	
Insertion loss	≤ 0.1 dB (non adjacent)	
Output	1 5/8" EIA	3 1/8" EIA male
Peak output voltage	≤ 7.7 kV	≤ 12.7 kV
Average output power	≤ 13.5 kW	-
Isolation between inputs	≥ 35 dB	
VSWR	≤ 1.1	
Dimensions (L x W x H) mm	≈ 1000 x 390 x 1420	
Weight	≈ 155 kg	≈ 160 kg
Environmental conditions	For limitations see „Environmental Conditions for Broadcast Products“.	

CCS UHF Stretchline Combiners

- **CCS** compact design
- Suitable for analogue and digital TV
- For 6, 7 and 8 MHz channel bandwidth

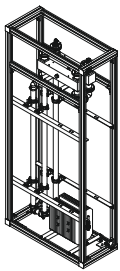
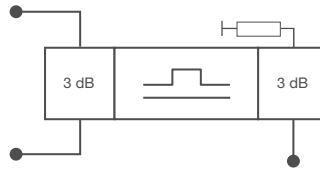

Typical design

Multi Channel Combiners

Part Number	BN 574931	BN 574634	BN 574635	BN 574636	BN 574637
Frequency range	470 - 860 MHz				
Channel spacing	≥ 3				
Narrowband input	7-16 female	1 5/8" EIA	3 1/8" EIA male	4 1/2" EIA male	4 1/2" EIA
Average input power	≤ 0.8 kW	≤ 7 kW	≤ 17.5 kW	≤ 23 kW	≤ 37 kW
DTV mask filtering	No				
Insertion loss Channel spacing ≥ 3	Typ. ≤ 0.7dB	Typ. ≤ 0.5 dB			
Insertion loss Channel spacing ≥ 5	Typ. ≤ 0.3 dB	Typ. ≤ 0.1 dB			
Output	7-16 female	3 1/8" EIA male	4 1/2" EIA	6 1/8" EIA	
Peak output voltage	≤ 2 kV	≤ 12.5 kV	≤ 18 kV	≤ 22 kV	≤ 34 kV
Isolation between inputs	≥ 34 dB				
VSWR	≤ 1.06				
Dimensions (L x W x H) mm	600 x 483 x 90	900 x 390 x 1980		900 x 480 x 1980	
Weight	≈ 12 kg	≈ 62 kg	≈ 115 kg	≈ 170 kg	≈ 200 kg
Environmental conditions	For limitations see „Environmental Conditions for Broadcast Products“.				

UHF Starpoint Combiners

- Compact design as 19" slide-in unit
- Integrated mask filters for DTV
- Applicable within the whole UHF range
- For 6, 7 and 8 MHz channel bandwidth
- Temperature compensated
- Wall mount available

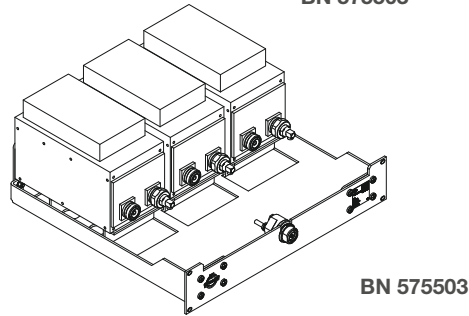
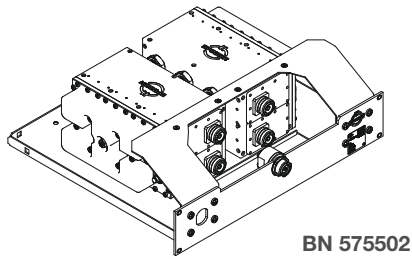
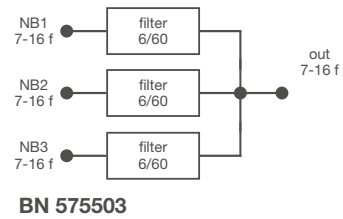
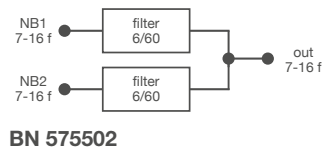

Part Number Number of Inputs	BN 575502 2-Way		BN 575503 3-Way						
Frequency range	470 - 860 MHz								
Channel spacing	≥ 1								
Narrowband inputs	7-16 female								
Filter type integrated cavities/size	6/60 ≡ BN 616566								
Temperature stability	≤ 2 kHz / K								
Harmonics attenuation	≥ 50 dB for f ≤ 1200 MHz								
DTV mask filtering	DVB-T @ 8 MHz ($\dot{U}/U_{rms}=13$ dB)	ISDB-T @ 6 MHz ($\dot{U}/U_{rms}=13$ dB)	ATSC 1.0 @ 6 MHz ($\dot{U}/U_{rms}=11$ dB)						
Average input power	≤ 375 W		≤ 300 W	≤ 300 W					
Tuning instruction	AS6201		AS6192	AS6257					
Insertion loss & mask filtering (alternative tuning on request)	470 MHz	860 MHz	470 MHz	803 MHz	470 MHz	803 MHz			
	f_0	≤ 0.55 dB	≤ 0.65 dB	f_0	≤ 0.7 dB	≤ 0.85 dB	f_0	≤ 0.8 dB	≤ 1.1 dB
	$f_0 \pm 3.805$	≤ 1.35 dB	≤ 1.85 dB	$f_0 \pm 2.79$	≤ 1.7 dB	≤ 2.3 dB	$f_0 \pm 2.69$	≤ 1.5 dB	≤ 1.8 dB
	$f_0 \pm 3.885$	≤ 1.55 dB	≤ 2.10 dB	$f_0 \pm 3.00$	≥ 4 dB		$f_0 \pm 3.0$	≤ 2.7 dB	≤ 2.8 dB
	$f_0 \pm 4.2$	≥ 4 dB		$f_0 \pm 3.15$	≥ 8 dB		$f_0 \pm 3.25$	≥ 4 dB	
	$f_0 \pm 6.0$	≥ 20 dB		$f_0 \pm 4.5$	≥ 23 dB		$f_0 \pm 4.0$	≥ 15 dB	
	$f_0 \pm 12.0$	≥ 40 dB		$f_0 \pm 9.0$	≥ 48 dB		$f_0 \pm 6.0$	≥ 40 dB	
				$f_0 \pm 15.0$	≥ 50 dB		$f_0 \pm 9.0$	≥ 65 dB	
Group delay variation	$\Delta\tau \leq 350$ ns		$\Delta\tau \leq 350$ ns		$\Delta\tau \leq 200$ ns				
Output	7-16 female								
Average output power	≤ 900 W								
Peak output voltage	≤ 2 kV								
Isolation between inputs	≥ 35 dB								
VSWR	≤ 1.2								
Dimensions (L x W x H) mm	404 x 483 x 136		533 x 483 x 206						
Weight	≈ 17 kg		≈ 26 kg						
Environmental conditions	For limitations see „Environmental Conditions for Broadcast Products“.								

CCS UHF Starpoint Combiners

- **CCS** compact design
- Integrated mask filters for DTV
- Applicable within the whole UHF range
- For 6, 7 and 8 MHz channel bandwidth
- Temperature compensated

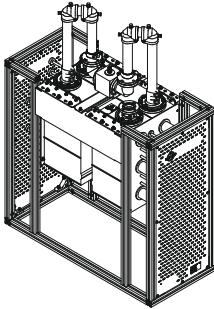

Typical design

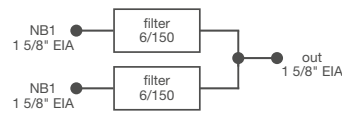

BN 574610

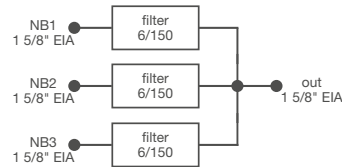

BN 574611

Multi Channel Combiners

Part Number Number of Inputs	BN 574610 2-Way		BN 574611 3-Way						
Frequency range	470 - 860 MHz								
Channel spacing	≥ 1								
Narrowband input	1 5/8" EIA								
Filter type integrated cavities/size	6/150 ≡ BN 616518								
Temperature stability	≤ 2 kHz / K								
Harmonics attenuation	≥ 50 dB for f ≤ 860 MHz								
DTV mask filtering	DVB-T @ 8 MHz ($\dot{U}/U_{rms}=13$ dB)	ISDB-T @ 6 MHz ($\dot{U}/U_{rms}=13$ dB)	DVB-T @ 7 MHz ($\dot{U}/U_{rms}=13$ dB)						
Average input power	≤ 2.5 kW	≤ 2.0 kW	≤ 2.25 kW						
Tuning instruction	AS6193	AS6184	AS6289						
Insertion loss & mask filtering (alternative tuning on request)	470 MHz	860 MHz	470 MHz	803 MHz	470 MHz	820 MHz			
	f_0	≤ 0.4 dB	≤ 0.55 dB	f_0	≤ 0.5 dB	≤ 0.7 dB	f_0	≤ 0.45 dB	≤ 0.60 dB
	$f_0 \pm 3.805$	≤ 0.85 dB	≤ 1.3 dB	$f_0 \pm 2.79$	≤ 1.2 dB	≤ 1.6 dB	$f_0 \pm 3.2$	≤ 0.65 dB	≤ 0.95 dB
	$f_0 \pm 3.885$	≤ 1.05 dB	≤ 1.5 dB	$f_0 \pm 3.00$	≥ 3.5 dB		$f_0 \pm 4.2$	≥ 13 dB	
	$f_0 \pm 4.2$	≥ 4 dB		$f_0 \pm 3.15$	≥ 8 dB		$f_0 \pm 10.5$	≥ 38 dB	
	$f_0 \pm 6.0$	≥ 20 dB		$f_0 \pm 4.5$	≥ 23 dB				
	$f_0 \pm 12.0$	≥ 40 dB		$f_0 \pm 9.0$	≥ 48 dB				
			$f_0 \pm 15.0$	≥ 50 dB					
Group delay variation	$\Delta\tau \leq 350$ ns		$\Delta\tau \leq 500$ ns		$\Delta\tau \leq 150$ ns				
Output	1 5/8" EIA male								
Isolation between inputs	≥ 35 dB								
VSWR	≤ 1.2								
Dimensions (L x W x H) mm	900 x 390 x 1200		900 x 780 x 1200						
Weight	≈ 80 kg		≈ 130 kg						
Environmental conditions	For limitations see „Environmental Conditions for Broadcast Products“.								

CCS UHF Starpoint Combiners

- **CCS** compact design
- Integrated mask filters for DTV
- Applicable within the whole UHF range
- For 6, 7 and 8 MHz channel bandwidth
- Temperature compensated

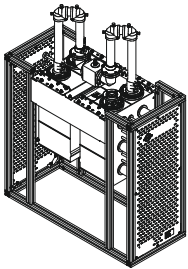

Typical design

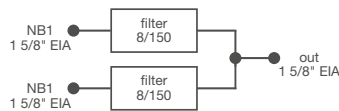

BN 574612

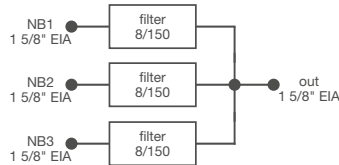

BN 574613

Part Number Number of Inputs	BN 574612 2-Way				BN 574613 3-Way				
Frequency range	470 - 860 MHz								
Channel spacing	≥ 1								
Narrowband input	1 5/8" EIA								
Filter type integrated cavities/size	8/150 ≡ BN 616542								
Temperature stability	≤ 2 kHz / K								
Harmonics attenuation	≥ 50 dB for f ≤ 860 MHz								
DTV mask filtering	DVB-T @ 8 MHz ($\dot{U}/U_{rms}=13$ dB)		ISDB-T @ 6 MHz ($\dot{U}/U_{rms}=13$ dB)		DVB-T @ 7 MHz ($\dot{U}/U_{rms}=13$ dB)				
Average input power	≤ 2.0 kW		≤ 1.6 kW		≤ 1.6 kW				
Tuning instruction	AS8071		AS8096		AS8094				
Insertion loss & mask filtering (alternative tuning on request)		470 MHz	860 MHz		470 MHz	803 MHz	470 MHz	803 MHz	
	f_0	≤ 0.5 dB	≤ 0.75 dB	f_0	≤ 0.6 dB	≤ 0.80 dB	f_0	≤ 0.8 dB	≤ 1.0 dB
	$f_0 \pm 3.805$	≤ 1.6 dB	≤ 2.2 dB	$f_0 \pm 2.79$	≤ 1.4 dB	≤ 1.85 dB	$f_0 \pm 2.69$	≤ 1.6 dB	≤ 1.7 dB
	$f_0 \pm 3.885$	≤ 1.8 dB	≤ 2.5 dB	$f_0 \pm 3.15$	≥ 15 dB		$f_0 \pm 3.00$	≥ 4.0 dB	
	$f_0 \pm 4.2$	≥ 15 dB		$f_0 \pm 4.5$	≥ 30 dB		$f_0 \pm 3.25$	≥ 18 dB	
	$f_0 \pm 6.0$	≥ 40 dB		$f_0 \pm 9.0$	≥ 55 dB		$f_0 \pm 9.00$	≥ 64 dB	
	$f_0 \pm 12.0$	≥ 55 dB							
Group delay variation	$\Delta\tau \leq 500$ ns		$\Delta\tau \leq 500$ ns		$\Delta\tau \leq 400$ ns				
Output	1 5/8" EIA male								
Isolation between inputs	≥ 35 dB								
VSWR	≤ 1.2								
Dimensions (L x W x H) mm	900 x 390 x 1200				900 x 780 x 1200				
Weight	≈ 120 kg				≈ 175 kg				
Environmental conditions	For limitations see „Environmental Conditions for Broadcast Products“.								

UHF Low-Power Manifold Combiners

- 4 RU compact design as 19" slide-in unit
- Suitable for analogue and digital TV
- Applicable within the whole UHF range
- For 6, 7 and 8 MHz channel bandwidth
- Temperature compensated



Typical design

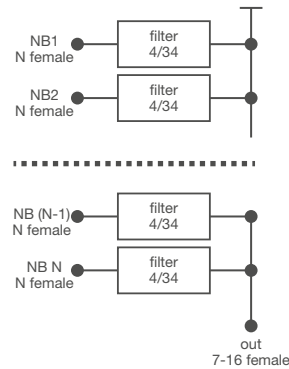

Multi Channel Combiners

Part Number	BN 574582 2 Inputs		BN 574583 3 Inputs		BN 574584 4 Inputs		BN 574585 5 Inputs	
Frequency range	470 - 860 MHz							
Channel spacing	≥ 2 (1 channel available on request)							
Narrowband input	N female							
Filter type integrated cavities/size	4/34 ≡ BN 616507							
Temperature stability	≤ 10 kHz / K							
Harmonics attenuation	≥ 50 dB for f ≤ 1500 MHz							
DTV mask filtering	No							
Average input power/channel width	50 W per input / 8 MHz 45 W per input / 7 MHz 40 W per input / 6 MHz							
Insertion loss (varying with sequence) AS4054 for 8 MHz (Û/U _{rms} =13 dB)	f ₀ 0.7 - 0.85 dB	f ₀ 0.7 - 0.9 dB	f ₀ 0.7 - 1.0 dB	f ₀ 0.7 - 1.1 dB	f ₀ 0.7 - 1.1 dB	f ₀ 0.7 - 1.1 dB	f ₀ 0.7 - 1.1 dB	f ₀ 0.7 - 1.1 dB
	f ₀ ± 3.885 0.8 - 0.95 dB	f ₀ ± 3.885 0.8 - 1.0 dB	f ₀ ± 3.885 0.8 - 1.1 dB	f ₀ ± 3.885 0.8 - 1.2 dB	f ₀ ± 3.885 0.8 - 1.2 dB	f ₀ ± 3.885 0.8 - 1.2 dB	f ₀ ± 3.885 0.8 - 1.2 dB	f ₀ ± 3.885 0.8 - 1.2 dB
	f ₀ ± 12.0 ≥ 17 dB	f ₀ ± 12.0 ≥ 17 dB	f ₀ ± 12.0 ≥ 17 dB	f ₀ ± 12.0 ≥ 17 dB	f ₀ ± 12.0 ≥ 17 dB	f ₀ ± 12.0 ≥ 17 dB	f ₀ ± 12.0 ≥ 17 dB	f ₀ ± 12.0 ≥ 17 dB
Group delay variation	Δτ ≤ 100 ns							
Insertion loss (varying with sequence) AS4046 for 7 MHz (Û/U _{rms} =13 dB)	f ₀ 0.75 - 0.9 dB	f ₀ 0.75 - 0.95 dB	f ₀ 0.75 - 1.05 dB	f ₀ 0.75 - 1.15 dB	f ₀ 0.75 - 1.15 dB	f ₀ 0.75 - 1.15 dB	f ₀ 0.75 - 1.15 dB	f ₀ 0.75 - 1.15 dB
	f ₀ ± 3.325 0.85 - 1.0 dB	f ₀ ± 3.325 0.85 - 1.05 dB	f ₀ ± 3.325 0.85 - 1.15 dB	f ₀ ± 3.325 0.85 - 1.25 dB	f ₀ ± 3.325 0.85 - 1.25 dB	f ₀ ± 3.325 0.85 - 1.25 dB	f ₀ ± 3.325 0.85 - 1.25 dB	f ₀ ± 3.325 0.85 - 1.25 dB
	f ₀ ± 10.5 ≥ 20 dB	f ₀ ± 10.5 ≥ 20 dB	f ₀ ± 10.5 ≥ 20 dB	f ₀ ± 10.5 ≥ 20 dB	f ₀ ± 10.5 ≥ 20 dB	f ₀ ± 10.5 ≥ 20 dB	f ₀ ± 10.5 ≥ 20 dB	f ₀ ± 10.5 ≥ 20 dB
Group delay variation	Δτ ≤ 65 ns							
Insertion loss (varying with sequence) AS4029 for 6 MHz (Û/U _{rms} =11 dB)	f ₀ 0.8 - 0.95 dB	f ₀ 0.8 - 1.0 dB	f ₀ 0.8 - 1.1 dB	f ₀ 0.8 - 1.2 dB	f ₀ 0.8 - 1.2 dB	f ₀ 0.8 - 1.2 dB	f ₀ 0.8 - 1.2 dB	f ₀ 0.8 - 1.2 dB
	f ₀ ± 2.885 0.9 - 1.05 dB	f ₀ ± 2.885 0.9 - 1.1 dB	f ₀ ± 2.885 0.9 - 1.2 dB	f ₀ ± 2.885 0.9 - 1.3 dB	f ₀ ± 2.885 0.9 - 1.3 dB	f ₀ ± 2.885 0.9 - 1.3 dB	f ₀ ± 2.885 0.9 - 1.3 dB	f ₀ ± 2.885 0.9 - 1.3 dB
	f ₀ ± 9.0 ≥ 25 dB	f ₀ ± 9.0 ≥ 25 dB	f ₀ ± 9.0 ≥ 25 dB	f ₀ ± 9.0 ≥ 25 dB	f ₀ ± 9.0 ≥ 25 dB	f ₀ ± 9.0 ≥ 25 dB	f ₀ ± 9.0 ≥ 25 dB	f ₀ ± 9.0 ≥ 25 dB
Group delay variation	Δτ ≤ 30 ns							
Output	7-16 female							
Peak output voltage	≤ 2 kV							
Isolation between inputs	≥ 25 dB							
VSWR (one WB channel)	≤ 1.2							
Dimensions (L x W x H) mm	340 x 483 x 177 (4RU)							
Weight	≈ 5 kg	≈ 8 kg	≈ 9 kg	≈ 9 kg	≈ 9 kg	≈ 9 kg	≈ 10 kg	≈ 10 kg
Environmental conditions	For limitations see „Environmental Conditions for Broadcast Products“.							

UHF Low-Power Manifold Combiners

- 4 RU compact design as 19" slide-in unit
- Suitable for analogue and digital TV
- Applicable within the whole UHF range
- For 6, 7 and 8 MHz channel bandwidth
- Temperature compensated



Typical design

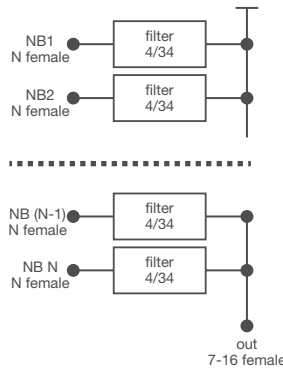

Part Number	BN 574586 6 Inputs		BN 574587 7 Inputs		BN 574588 8 Inputs		BN 574589 9 Inputs	
Frequency range	470 - 860 MHz							
Channel spacing	≥ 2 (1 channel available on request)							
Narrowband input	N female							
Filter type integrated cavities/size	4/34 ≡ BN 616507							
Temperature stability	≤ 10 kHz / K							
Harmonics attenuation	≥ 50 dB for f ≤ 1500 MHz							
DTV mask filtering	No							
Average input power/channel width	50 W per input / 8 MHz 45 W per input / 7 MHz 40 W per input / 6 MHz							
Insertion loss (varying with sequence) AS4054 for 8 MHz ($\dot{U}/U_{rms}=13$ dB)	f_0 0.7 - 1.15 dB	$f_0 \pm 3.885$ 0.8 - 1.25 dB	f_0 0.7 - 1.2 dB	$f_0 \pm 3.885$ 0.8 - 1.3 dB	f_0 0.7 - 1.3 dB	$f_0 \pm 3.885$ 0.8 - 1.4 dB	f_0 0.7 - 1.4 dB	$f_0 \pm 3.885$ 0.8 - 1.5 dB
	$f_0 \pm 12.0$ ≥ 17 dB	$f_0 \pm 12.0$ ≥ 17 dB	$f_0 \pm 12.0$ ≥ 17 dB	$f_0 \pm 12.0$ ≥ 17 dB	$f_0 \pm 12.0$ ≥ 17 dB	$f_0 \pm 12.0$ ≥ 17 dB	$f_0 \pm 12.0$ ≥ 17 dB	$f_0 \pm 12.0$ ≥ 17 dB
Group delay variation	$\Delta\tau \leq 100$ ns							
Insertion loss (varying with sequence) AS4046 for 7 MHz ($\dot{U}/U_{rms}=13$ dB)	f_0 0.75 - 1.2 dB	$f_0 \pm 3.325$ 0.85 - 1.3 dB	f_0 0.75 - 1.25 dB	$f_0 \pm 3.325$ 0.85 - 1.35 dB	f_0 0.75 - 1.35 dB	$f_0 \pm 3.325$ 0.85 - 1.45 dB	f_0 0.75 - 1.45 dB	$f_0 \pm 3.325$ 0.85 - 1.45 dB
	$f_0 \pm 10.5$ ≥ 20 dB	$f_0 \pm 10.5$ ≥ 20 dB	$f_0 \pm 10.5$ ≥ 20 dB	$f_0 \pm 10.5$ ≥ 20 dB	$f_0 \pm 10.5$ ≥ 20 dB	$f_0 \pm 10.5$ ≥ 20 dB	$f_0 \pm 10.5$ ≥ 20 dB	$f_0 \pm 10.5$ ≥ 20 dB
Group delay variation	$\Delta\tau \leq 65$ ns							
Insertion loss (varying with sequence) AS4029 for 6 MHz ($\dot{U}/U_{rms}=11$ dB)	f_0 0.8 - 1.25 dB	$f_0 \pm 2.885$ 0.9 - 1.35 dB	f_0 0.8 - 1.3 dB	$f_0 \pm 2.885$ 0.9 - 1.4 dB	f_0 0.8 - 1.4 dB	$f_0 \pm 2.885$ 0.9 - 1.5 dB	f_0 0.8 - 1.5 dB	$f_0 \pm 2.885$ 0.9 - 1.6 dB
	$f_0 \pm 9.0$ ≥ 25 dB	$f_0 \pm 9.0$ ≥ 25 dB	$f_0 \pm 9.0$ ≥ 25 dB	$f_0 \pm 9.0$ ≥ 25 dB	$f_0 \pm 9.0$ ≥ 25 dB	$f_0 \pm 9.0$ ≥ 25 dB	$f_0 \pm 9.0$ ≥ 25 dB	$f_0 \pm 9.0$ ≥ 25 dB
Group delay variation	$\Delta\tau \leq 30$ ns							
Output	7-16 female							
Average output power	≤ 450 W							
Peak output voltage	≤ 2 kV							
Isolation between inputs	≥ 25 dB							
VSWR (one WB channel)	≤ 1.2							
Dimensions (L x W x H) mm	340 x 483 x 177 (4RU)							
Weight	≈ 12 kg	≈ 13 kg	≈ 15 kg	≈ 15 kg	≈ 15 kg	≈ 18 kg	≈ 18 kg	≈ 18 kg
Environmental conditions	For limitations see „Environmental Conditions for Broadcast Products“.							

UHF Manifold Combiners

- Compact design as 19" slide-in unit
- Integrated mask filters for DTV
- Applicable within the whole UHF range
- For 6, 7 and 8 MHz channel bandwidth
- Temperature compensated

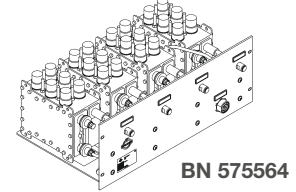
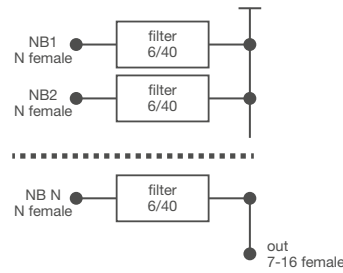
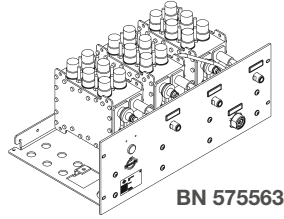
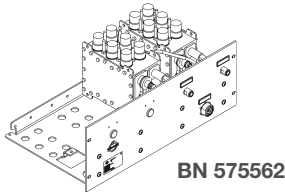

Part Number	BN 575562 - 2 Inputs	BN 575563 - 3 Inputs	BN 575564 - 4 Inputs
Frequency range	470 - 860 MHz		
Narrowband input	N female		
Filter type integrated cavities/size	6/40 ≡ BN 616660		
Temperature stability	≤ 2 kHz / K		
Harmonics attenuation	≥ 60 dB for f ≤ 1400 MHz		
Standard	DVB-T @ 8 MHz, (Û/U _{rms} =13 dB)		
Average input power/channel width	130 W per input for non-adjacent channels or 100 W for adjacent channels		
Channel spacing	≥ 0 (pairs of adjacent channels possible)		
Tuning instruction AS6361	f ₀ 0.8 - 1.1 dB	f ₀ 0.9 - 1.2 dB	f ₀ 0.9 - 1.2 dB
Insertion loss for non-adjacent channels	f ₀ ± 3.805 2.0 - 2.5 dB	f ₀ ± 3.805 2.0 - 2.6 dB	f ₀ ± 3.805 2.0 - 2.7 dB
	f ₀ ± 3.885 2.3 - 2.8 dB	f ₀ ± 3.885 2.3 - 2.9 dB	f ₀ ± 3.885 2.3 - 3.0 dB
Mask filtering		f ₀ ± 4.2 ≥ 4 dB	
		f ₀ ± 6 ≥ 20 dB	
		f ₀ ± 12 ≥ 40 dB	
Group delay variation	Δτ ≤ 350 ns (≤ 500 ns at adjacent channel slopes)		
Isolation between inputs	≥ 35 dB (for adjacent channels: ≥ 30 dBrms in channel and 15 dB at adjacent channel slopes)		
Standard	ISDB-T @ 6 MHz, (Û/U _{rms} =13 dB)		
Average input power/channel width	100 W per input for non-adjacent channels or 75 W for adjacent channels		
Channel spacing	≥ 0 (pairs of adjacent channels possible)		
Tuning instruction AS6368	f ₀ 1.1 - 1.4 dB	f ₀ 1.1 - 1.5 dB	f ₀ 1.1 - 1.6 dB
Insertion loss for non-adjacent channels	f ₀ ± 2.79 2.7 - 3.3 dB	f ₀ ± 2.79 2.7 - 3.4 dB	f ₀ ± 2.79 2.7 - 3.5 dB
Mask filtering		f ₀ ± 3 ≥ 4 dB	
		f ₀ ± 3.15 ≥ 8 dB	
		f ₀ ± 4.5 ≥ 22 dB	
		f ₀ ± 9 ≥ 50 dB	
		f ₀ ± 15 ≥ 50 dB	
Group delay variation	Δτ ≤ 350 ns		
Isolation between inputs	≥ 35 dB (for adjacent channels: ≥ 30 dBrms in channel and 15 dB at adjacent channel slopes)		
Standard	ATSC 1.0 @ 6 MHz, (Û/U _{rms} =11 dB)		
Average input power/channel width	100 W per input for non-adjacent channels or 75 W for adjacent channels		
Channel spacing	≥ 0 (pairs of adjacent channels possible)		
Tuning instruction AS6362	f ₀ 1.3 - 1.8 dB	f ₀ 1.3 - 1.9 dB	f ₀ 1.3 - 2.0 dB
Insertion loss for non-adjacent channels	f ₀ ± 2.69 2.3 - 2.7 dB	f ₀ ± 2.69 2.3 - 2.8 dB	f ₀ ± 2.69 2.3 - 2.9 dB
Mask filtering		f ₀ ± 3.25 ≥ 4 dB	
		f ₀ ± 3.5 ≥ 8 dB	
		f ₀ ± 4 ≥ 15 dB	
		f ₀ ± 6 ≥ 40 dB	
		f ₀ ± 9 ≥ 65 dB	
Group delay variation	Δτ ≤ 200 ns		
Isolation between inputs	≥ 35 dB (for adjacent channels: ≥ 30 dBrms in channel and 15 dB at adjacent channel slopes)		
Output	7-16 female		
Average output power	≤ 600 W		
Peak output voltage	≤ 2 kV		
VSWR	≤ 1.15		≤ 1.2
Dimensions (L x W x H) mm	300 x 483 x 177 (4RU)		
Weight	≈ 9 kg	≈ 13 kg	≈ 17 kg
Environmental conditions	For limitations see „Environmental Conditions for Broadcast Products“.		

Multi Channel Combiners

UHF Manifold Combiners

- Compact design as 19" slide-in unit
- Integrated mask filters for DTV
- Applicable within the whole UHF range
- For 6, 7 and 8 MHz channel bandwidth
- Temperature compensated

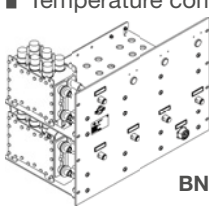

BN 575565

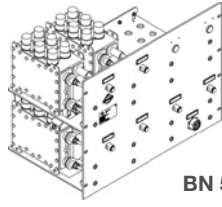

BN 575566

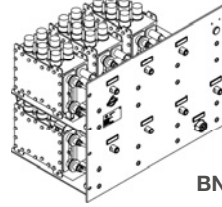
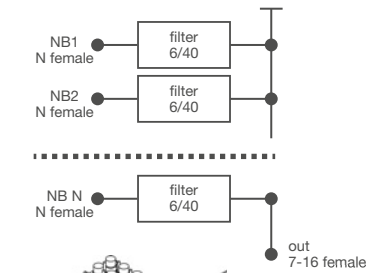

BN 575567

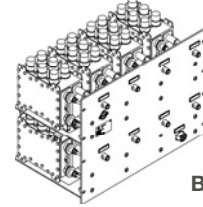

BN 575568

Part Number	BN 575565 - 5 Inputs	BN 575566 - 6 Inputs	BN 575567 - 7 Inputs	BN 575568 - 8 Inputs
Frequency range	470 - 860 MHz			
Narrowband input	N female			
Filter type integrated cavities/size	6/40 ≡ BN 616660			
Temperature stability	≤ 2 kHz / K			
Harmonics attenuation	≥ 60 dB for f ≤ 1400 MHz			
Standard	DVB-T @ 8 MHz, (Û/U _{rms} =13 dB)			
Average input power/channel width	130 W per input for non-adjacent channels or 100 W for adjacent channels			
Channel spacing	≥ 0 (pairs of adjacent channels possible)			
Tuning instruction AS6361	f ₀ 0.9-1.3 dB	f ₀ 0.9-1.3 dB	f ₀ 0.9-1.4 dB	f ₀ 0.9-1.5 dB
Insertion loss for non-adjacent channels	f ₀ ± 3.805 2.0-2.8 dB	f ₀ ± 3.805 2.0-2.8 dB	f ₀ ± 3.805 2.0-2.9 dB	f ₀ ± 3.805 2.0-3.0 dB
	f ₀ ± 3.885 2.3-3.1 dB	f ₀ ± 3.885 2.3-3.1 dB	f ₀ ± 3.885 2.3-3.2 dB	f ₀ ± 3.885 2.3-3.3 dB
Mask filtering	f ₀ ± 4.2 ≥ 4 dB f ₀ ± 6 ≥ 20 dB f ₀ ± 12 ≥ 40 dB			
Group delay variation	Δτ ≤ 350 ns (≤ 500 ns at adjacent channel slopes)			
Isolation between inputs	≥ 35 dB (for adjacent channels: ≥ 30 dBrms in channel and 15 dB at adjacent channel slopes)			
Standard	ISDB-T @ 6 MHz, (Û/U _{rms} =13 dB)			
Average input power/channel width	100 W per input for non-adjacent channels or 75 W for adjacent channels			
Channel spacing	≥ 0 (pairs of adjacent channels possible)			
Tuning instruction AS6368	f ₀ 1.1-1.7 dB	f ₀ 1.1-1.7 dB	f ₀ 1.1-1.8 dB	f ₀ 1.1-1.9 dB
Insertion loss for non-adjacent channels	f ₀ ± 2.79 2.7-3.6 dB	f ₀ ± 2.79 2.7-3.6 dB	f ₀ ± 2.79 2.7-3.7 dB	f ₀ ± 2.79 2.7-3.8 dB
	f ₀ ± 3 ≥ 4 dB f ₀ ± 3.15 ≥ 8 dB f ₀ ± 4.5 ≥ 22 dB f ₀ ± 9 ≥ 50 dB f ₀ ± 15 ≥ 50 dB			
Mask filtering	Δτ ≤ 350 ns			
Group delay variation	Δτ ≤ 350 ns			
Isolation between inputs	≥ 35 dB (for adjacent channels: ≥ 30 dBrms in channel and 15 dB at adjacent channel slopes)			
Standard	ATSC 1.0 @ 6 MHz, (Û/U _{rms} =11 dB)			
Average input power/channel width	100 W per input for non-adjacent channels or 75 W for adjacent channels			
Channel spacing	≥ 0 (pairs of adjacent channels possible)			
Tuning instruction AS6362	f ₀ 1.3-2.1 dB	f ₀ 1.3-2.1 dB	f ₀ 1.3-2.2 dB	f ₀ 1.3-2.3 dB
Insertion loss for non-adjacent channels	f ₀ ± 2.69 2.3-3.0 dB	f ₀ ± 2.69 2.3-3.0 dB	f ₀ ± 2.69 2.3-3.1 dB	f ₀ ± 2.69 2.3-3.2 dB
	f ₀ ± 3.25 ≥ 4 dB f ₀ ± 3.5 ≥ 8 dB f ₀ ± 4 ≥ 15 dB f ₀ ± 6 ≥ 40 dB f ₀ ± 9 ≥ 65 dB			
Mask filtering	Δτ ≤ 200 ns			
Group delay variation	Δτ ≤ 200 ns			
Isolation between inputs	≥ 35 dB (for adjacent channels: ≥ 30 dBrms in channel and 15 dB at adjacent channel slopes)			
Output	7-16 female			
Average output power	≤ 600 W			
Peak output voltage	≤ 2 kV			
VSWR	≤ 1.2			
Dimensions (L x W x H) mm	300 x 483 x 355 (8RU)			
Weight	≈ 21 kg	≈ 25 kg	≈ 29 kg	≈ 32 kg
Environmental conditions	For limitations see „Environmental Conditions for Broadcast Products“.			

UHF Manifold Combiners

- Compact design as 19" slide-in unit
- Integrated mask filters for DTV
- Applicable within the whole UHF range
- For 6, 7 and 8 MHz channel bandwidth
- Temperature compensated

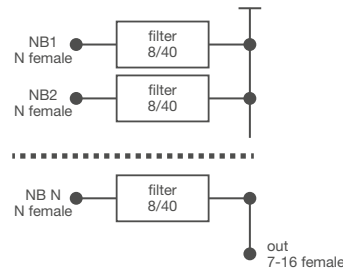
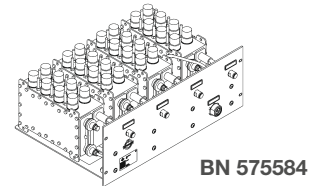
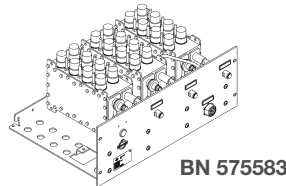
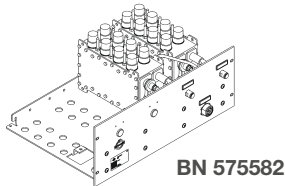

Part Number	BN 575582 - 2 Inputs	BN 575583 - 3 Inputs	BN 575584 - 4 Inputs
Frequency range	470 - 860 MHz		
Narrowband input	N female		
Filter type integrated cavities/size	8/40 ≡ BN 616661		
Temperature stability	≤ 2 kHz / K		
Harmonics attenuation	≥ 60 dB for f ≤ 1400 MHz		
Standard	DVB-T @ 8 MHz, ($\hat{U}/U_{rms}=13$ dB)		
Average input power/channel width	120 W per input for non-adjacent channels or 85 W for adjacent channels		
Channel spacing	≥ 0 (pairs of adjacent channels possible)		
Tuning instruction AS8131	f_0 1.3-1.7 dB	f_0 1.3-1.8 dB	f_0 1.3-1.9 dB
Insertion loss for non-adjacent channels	$f_0 \pm 3.805$ 3.7-5.5 dB $f_0 \pm 3.885$ 4.5-6.1 dB	$f_0 \pm 3.805$ 3.8-5.6 dB $f_0 \pm 3.885$ 4.5-6.2 dB	$f_0 \pm 3.805$ 3.8-5.7 dB $f_0 \pm 3.885$ 4.5-6.3 dB
Mask filtering	$f_0 \pm 4.2$ ≥ 15 dB $f_0 \pm 6$ ≥ 40 dB $f_0 \pm 12$ ≥ 55 dB		
Group delay variation	$\Delta\tau \leq 650$ ns (≤ 800 ns at adjacent channel slopes)		
Isolation between inputs	≥ 35 dB (for adjacent channels: ≥ 30 dBrms in channel and 15 dB at adjacent channel slopes)		
Standard	ISDB-T @ 6 MHz, ($\hat{U}/U_{rms}=13$ dB)		
Average input power/channel width	100 W per input		
Channel spacing	≥ 1		
Tuning instruction AS8133	f_0 1.6-1.9 dB	f_0 1.6-2.0 dB	f_0 1.6-2.1 dB
Insertion loss for non-adjacent channels	$f_0 \pm 2.79$ 4.6-5.3 dB	$f_0 \pm 2.79$ 4.6-5.4 dB $f_0 \pm 3.15$ ≥ 15 dB $f_0 \pm 4.5$ ≥ 30 dB $f_0 \pm 9$ ≥ 55 dB $f_0 \pm 15$ ≥ 65 dB	$f_0 \pm 2.79$ 4.6-5.5 dB
Mask filtering	$f_0 \pm 9$ ≥ 55 dB $f_0 \pm 15$ ≥ 65 dB		
Group delay variation	$\Delta\tau \leq 500$ ns $\Delta\tau \leq 500$ ns		
Isolation between inputs	≥ 35 dB		
Standard	ATSC 1.0 @ 6 MHz, ($\hat{U}/U_{rms}=11$ dB)		
Average input power/channel width	100 W per input		
Channel spacing	≥ 1		
Tuning instruction AS8132	f_0 1.7-2.2 dB	f_0 1.7-2.3 dB	f_0 1.7-2.4 dB
Insertion loss for non-adjacent channels	$f_0 \pm 2.69$ 4.0-4.7 dB	$f_0 \pm 2.69$ 4.0-4.8 dB $f_0 \pm 3.25$ ≥ 5 dB $f_0 \pm 3.5$ ≥ 18 dB $f_0 \pm 9$ ≥ 64 dB	$f_0 \pm 2.69$ 4.0-4.9 dB
Mask filtering	$f_0 \pm 9$ ≥ 64 dB		
Group delay variation	$\Delta\tau \leq 400$ ns		
Isolation between inputs	≥ 35 dB		
Output	7-16 female		
Average output power	≤ 600 W		
Peak output voltage	≤ 2 kV		
VSWR	≤ 1.2		
Dimensions (L x W x H) mm	300 x 483 x 177 (4RU)		
Weight	≈ 10 kg	≈ 14 kg	≈ 18 kg
Environmental conditions	For limitations see „Environmental Conditions for Broadcast Products“.		

Multi Channel Combiners

UHF Manifold Combiners

- Compact design as 19" slide-in unit
- Integrated mask filters for DTV
- Applicable within the whole UHF range
- For 6, 7 and 8 MHz channel bandwidth
- Temperature compensated

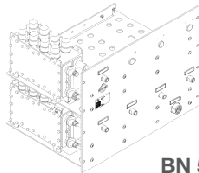
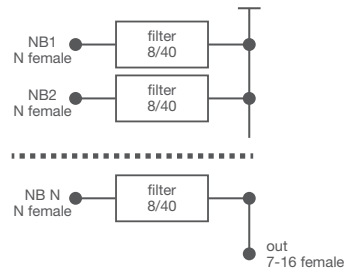

BN 575585

Part Number	BN 575585 - 5 Inputs	BN 575586 - 6 Inputs	BN 575587 - 7 Inputs	BN 575588 - 8 Inputs
Frequency range	470 - 860 MHz			
Narrowband input	N female			
Filter type integrated cavities/size	8/40 ≡ BN 616661			
Temperature stability	≤ 2 kHz / K			
Harmonics attenuation	≥ 60 dB for f ≤ 1400 MHz			
Standard	DVB-T @ 8 MHz, (Ū/U _{rms} =13 dB)			
Average input power/channel width	120 W per input for non-adjacent channels or 85 W for adjacent channels			
Channel spacing	≥ 0 (pairs of adjacent channels possible)			
Tuning instruction AS8131	f ₀ 1.4-2.0 dB	f ₀ 1.4-2.1 dB	f ₀ 1.4-2.2 dB	f ₀ 1.4-2.3 dB
Insertion loss for non-adjacent channels	f ₀ ± 3.805 3.8-5.7 dB	f ₀ ± 3.805 3.8-5.8 dB	f ₀ ± 3.805 3.8-5.9 dB	f ₀ ± 3.805 3.8-5.9 dB
	f ₀ ± 3.885 4.6-6.4 dB	f ₀ ± 3.885 4.6-6.5 dB	f ₀ ± 3.885 4.6-6.6 dB	f ₀ ± 3.885 4.6-6.7 dB
Mask filtering	f ₀ ± 4.2 ≥ 15 dB			
	f ₀ ± 6 ≥ 40 dB			
	f ₀ ± 12 ≥ 55 dB			
Group delay variation	Δτ ≤ 650 ns (≤ 800 ns at adjacent channel slopes)			
Isolation between inputs	≥ 35 dB (for adjacent channels: ≥ 30 dB _{rms} in channel and 15 dB at adjacent channel slopes)			
Standard	ISDB-T @ 6 MHz, (Ū/U _{rms} =13 dB)			
Average input power/channel width	100 W per input			
Channel spacing	≥ 1			
Tuning instruction AS8133	f ₀ 1.7-2.2 dB	f ₀ 1.7-2.3 dB	f ₀ 1.7-2.4 dB	f ₀ 1.7-2.5 dB
Insertion loss for non-adjacent channels	f ₀ ± 2.79 4.7-5.6 dB	f ₀ ± 2.79 4.7-5.7 dB	f ₀ ± 2.79 4.7-5.8 dB	f ₀ ± 2.79 4.7-5.9 dB
	f ₀ ± 3.15 ≥ 15 dB			
Mask filtering	f ₀ ± 4.5 ≥ 30 dB			
	f ₀ ± 9 ≥ 55 dB			
	f ₀ ± 15 ≥ 65 dB			
Group delay variation	Δτ ≤ 500 ns			
Isolation between inputs	≥ 35 dB			
Standard	ATSC 1.0 @ 6 MHz, (Ū/U _{rms} =11 dB)			
Average input power/channel width	100 W per input			
Channel spacing	≥ 1			
Tuning instruction AS8132	f ₀ 1.8-2.5 dB	f ₀ 1.8-2.6 dB	f ₀ 1.8-2.7 dB	f ₀ 1.8-2.8 dB
Insertion loss for non-adjacent channels	f ₀ ± 2.69 4.1-5.0 dB	f ₀ ± 2.69 4.1-5.1 dB	f ₀ ± 2.69 4.1-5.2 dB	f ₀ ± 2.69 4.1-5.3 dB
	f ₀ ± 3 ≥ 5 dB			
Mask filtering	f ₀ ± 3.25 ≥ 18 dB			
	f ₀ ± 9 ≥ 64 dB			
Group delay variation	Δτ ≤ 400 ns			
Isolation between inputs	≥ 35 dB			
Output	7-16 female			
Average output power	≤ 600 W			
Peak output voltage	≤ 2 kV			
VSWR	≤ 1.2			
Dimensions (L x W x H) mm	300 x 483 x 355 (8RU)			
Weight	≈ 22 kg	≈ 26 kg	≈ 30 kg	≈ 34 kg
Environmental conditions	For limitations see „Environmental Conditions for Broadcast Products“.			

UHF Manifold Combiners

- Compact design as 19" slide-in unit
- Integrated mask filters for DTV
- Applicable within the whole UHF range
- For 6, 7 and 8 MHz channel bandwidth
- Temperature compensated

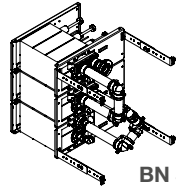
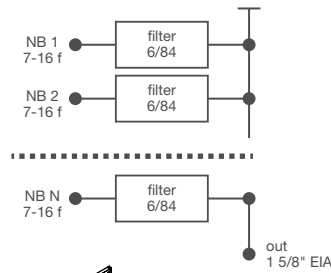

BN 574913C0003

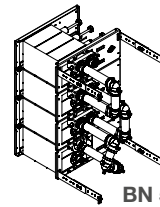

BN 574914C0003

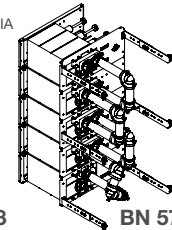

BN 574911C0003

Multi Channel Combiners

Part Number	BN 574912C0003 2 Inputs	BN 574913C0003 3 Inputs	BN 574914C0003 4 Inputs	BN 574911C0003 5 Inputs	BN 574960C0003 6 Inputs
Frequency range	470 - 860 MHz				
Narrowband input	7-16 female				
Filter type integrated cavities/size	6/84 ≡ BN 616402				
Temperature stability	≤ 2 kHz / K				
Harmonics attenuation	≥ 50 dB for f ≤ 950 MHz				
Standard	DVB-T @ 8 MHz, (Û/U _{rms} =13 dB)				
Average input power/channel width	750 W per input for non-adjacent channels or 600 W for adjacent channels				
Channel spacing	≥ 0 (pairs of adjacent channels possible)				
Tuning instruction AS6186	f ₀ 0.5-0.6 dB	f ₀ 0.5-0.8 dB	f ₀ 0.5-1.0 dB	f ₀ 0.5-1.1 dB	f ₀ 0.5-1.2 dB
Insertion loss for non-adjacent channels	f ₀ ± 3.805 1.2-1.5 dB	f ₀ ± 3.805 1.2-1.6 dB	f ₀ ± 3.805 1.2-1.9 dB	f ₀ ± 3.805 1.3-2.0 dB	f ₀ ± 3.805 1.2-2.1 dB
	f ₀ ± 3.885 1.3-1.6 dB	f ₀ ± 3.885 1.4-1.7 dB	f ₀ ± 3.885 1.4-2.0 dB	f ₀ ± 3.885 1.4-2.1 dB	f ₀ ± 3.885 1.4-2.2 dB
Mask filtering	f ₀ ± 4.2 ≥ 4 dB f ₀ ± 6 ≥ 20 dB f ₀ ± 12 ≥ 40 dB				
Group delay variation	Δτ ≤ 350 ns (≤ 700 ns at adjacent channel slopes)				
Isolation between inputs	≥ 35 dB (for adjacent channels: ≥ 26 dB _{rms} in channel and 12 dB at adjacent channel slopes)				
Standard	ISDB-T @ 6 MHz, (Û/U _{rms} =13 dB)				
Average input power/channel width	600 W per input for non-adjacent channels or 500 W for adjacent channels				
Channel spacing	≥ 0 (pairs of adjacent channels possible)				
Tuning instruction AS6182	f ₀ 0.6-0.8 dB	f ₀ 0.6-0.9 dB	f ₀ 0.6-1.1 dB	f ₀ 0.6-1.2 dB	f ₀ 0.6-1.3 dB
Insertion loss for non-adjacent channels	f ₀ ± 2.79 1.6-2.2 dB	f ₀ ± 2.79 1.7-2.3 dB	f ₀ ± 2.79 1.7-2.5 dB	f ₀ ± 2.79 1.6-2.6 dB	f ₀ ± 2.79 1.6-2.7 dB
			f ₀ ± 3 ≥ 4 dB	f ₀ ± 3.15 ≥ 8 dB	
Mask filtering	f ₀ ± 4.5 ≥ 23 dB f ₀ ± 9 ≥ 50 dB f ₀ ± 15 ≥ 50 dB				
Group delay variation	Δτ ≤ 500 ns (≤ 800 ns at adjacent channel slopes)				
Isolation between inputs	≥ 35 dB (for adjacent channels: ≥ 30 dB _{rms} in channel and 20 dB at adjacent channel slopes)				
Standard	ATSC 1.0 @ 6 MHz, (Û/U _{rms} =11 dB)				
Average input power/channel width	600 W per input for non-adjacent channels or 500 W for adjacent channels				
Channel spacing	≥ 0 (pairs of adjacent channels possible)				
Tuning instruction AS6156	f ₀ 0.7-0.9 dB	f ₀ 0.7-1.0 dB	f ₀ 0.7-1.2 dB	f ₀ 0.7-1.3 dB	f ₀ 0.7-1.4 dB
Insertion loss for non-adjacent channels	f ₀ ± 2.69 1.1-1.6 dB	f ₀ ± 2.69 1.2-1.7 dB	f ₀ ± 2.69 1.2-1.8 dB	f ₀ ± 2.69 1.2-1.9 dB	f ₀ ± 2.69 1.2-2.0 dB
	f ₀ ± 3.00 1.9-2.5 dB	f ₀ ± 3.00 1.9-2.6 dB	f ₀ ± 3.00 1.9-2.7 dB	f ₀ ± 3.00 1.9-2.8 dB	f ₀ ± 3.00 1.9-2.9 dB
Mask filtering	f ₀ ± 3.25 ≥ 4 dB f ₀ ± 3.5 ≥ 8 dB f ₀ ± 4 ≥ 15 dB f ₀ ± 6 ≥ 40 dB f ₀ ± 9 ≥ 65 dB				
Group delay variation	Δτ ≤ 200 ns (≤ 500 ns at adjacent channel slopes)				
Isolation between inputs	≥ 35 dB (for adjacent channels: ≥ 28 dB _{rms} in channel and 13 dB at adjacent channel slopes)				
Output	1 5/8" SMS clamp				
VSWR	≤ 1.17 (≤ 1.2 for adjacent channels)				
Dimensions (L x W x H) mm	640 x 483 x 354 (8RU)	640 x 483 x 532 (12RU)	640 x 483 x 809 (16RU)	640 x 483 x 888 (20RU)	640x483x1064(24RU)
Weight	≈ 26 kg	≈ 38 kg	≈ 51 kg	≈ 64 kg	≈ 76 kg
Environmental conditions	For limitations see „Environmental Conditions for Broadcast Products“.				

UHF Manifold Combiners

- Compact design as 19" slide-in unit
- Integrated mask filters for DTV
- Applicable within the whole UHF range
- For 6, 7 and 8 MHz channel bandwidth
- Temperature compensated

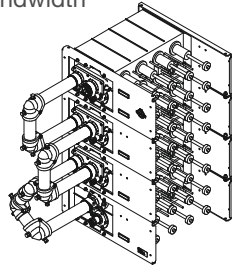

Typical design

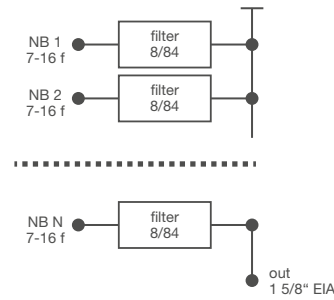

Part Number	BN 574922C0003 2 Inputs	BN 574923C0003 3 Inputs	BN 574924C0003 4 Inputs	BN 574921C0003 5 Inputs	BN 574998C0003 6 Inputs
Frequency range	470 - 860 MHz				
Narrowband input	7-16 female				
Filter type integrated cavities/size	8/84 ≡ BN 616403				
Temperature stability	≤ 2 kHz / K				
Harmonics attenuation	≥ 50 dB for f ≤ 950 MHz				
Standard	DVB-T @ 8 MHz, ($\hat{U}/U_{rms}=13$ dB)				
Average input power/channel width	750 W per input for non-adjacent channels or 600 W for adjacent channels				
Channel spacing	≥ 0 (pairs of adjacent channels possible)				
Tuning instruction AS8068	f_0 0.6-0.75 dB	f_0 0.6-0.9 dB	f_0 0.6-1.0 dB	f_0 0.6-1.1 dB	f_0 0.6-1.2 dB
Insertion loss for non-adjacent channels	$f_0 \pm 3.805$ 1.8-2.2 dB	$f_0 \pm 3.805$ 1.8-2.3 dB	$f_0 \pm 3.805$ 1.8-2.4 dB	$f_0 \pm 3.805$ 1.8-2.5 dB	$f_0 \pm 3.805$ 1.8-2.6 dB
	$f_0 \pm 3.885$ 2.1-2.6 dB	$f_0 \pm 3.885$ 2.1-2.7 dB	$f_0 \pm 3.885$ 2.1-2.8 dB	$f_0 \pm 3.885$ 2.1-2.9 dB	$f_0 \pm 3.885$ 2.1-3.0 dB
Mask filtering	$f_0 \pm 4.2$ ≥ 15 dB $f_0 \pm 6$ ≥ 40 dB $f_0 \pm 12$ ≥ 55 dB				
Group delay variation	$\Delta\tau \leq 600$ ns (at non-adjacent channel slopes)				
Isolation between inputs	≥ 35 dB (at non-adjacent channel slopes)				
Standard	ISDB-T @ 6 MHz, ($\hat{U}/U_{rms}=13$ dB)				
Average input power/channel width	600 W per input for non-adjacent channels or 500 W for adjacent channels				
Channel spacing	≥ 0 (pairs of adjacent channels possible)				
Tuning instruction AS8091	f_0 0.7-1.3 dB	f_0 0.7-1.4 dB	f_0 0.7-1.5 dB	f_0 0.7-1.6 dB	f_0 0.7-1.7 dB
Insertion loss for non-adjacent channels	$f_0 \pm 2.79$ 1.8-3.1 dB	$f_0 \pm 2.79$ 1.8-3.2 dB	$f_0 \pm 2.79$ 1.8-3.3 dB	$f_0 \pm 2.79$ 1.8-3.4 dB	$f_0 \pm 2.79$ 1.8-3.5 dB
	$f_0 \pm 3.15$ ≥ 15 dB $f_0 \pm 4.5$ ≥ 30 dB $f_0 \pm 9$ ≥ 55 dB				
Mask filtering	$f_0 \pm 3.15$ ≥ 15 dB $f_0 \pm 4.5$ ≥ 30 dB $f_0 \pm 9$ ≥ 55 dB				
Group delay variation	$\Delta\tau \leq 500$ ns (at non-adjacent channel slopes)				
Isolation between inputs	≥ 35 dB (at non-adjacent channel slopes)				
Standard	ATSC 1.0 @ 6 MHz, ($\hat{U}/U_{rms}=11$ dB)				
Average input power/channel width	600 W per input for non-adjacent channels or 500 W for adjacent channels				
Channel spacing	≥ 0 (pairs of adjacent channels possible)				
Tuning instruction AS8051	f_0 0.9-1.3 dB	f_0 0.9-1.4 dB	f_0 0.9-1.5 dB	f_0 0.9-1.6 dB	f_0 0.9-1.7 dB
Insertion loss for non-adjacent channels	$f_0 \pm 2.69$ 1.9-2.7 dB	$f_0 \pm 2.69$ 1.9-2.8 dB	$f_0 \pm 2.69$ 1.9-2.9 dB	$f_0 \pm 2.69$ 1.9-3.0 dB	$f_0 \pm 2.69$ 1.9-3.1 dB
	$f_0 \pm 3$ ≥ 3 dB $f_0 \pm 3.25$ ≥ 18 dB $f_0 \pm 9$ ≥ 64 dB				
Mask filtering	$f_0 \pm 3$ ≥ 3 dB $f_0 \pm 3.25$ ≥ 18 dB $f_0 \pm 9$ ≥ 64 dB				
Group delay variation	$\Delta\tau \leq 400$ ns (at non-adjacent channel slopes)				
Isolation between inputs	≥ 35 dB (at non-adjacent channel slopes)				
Output	1 5/8" SMS clamp				
VSWR	≤ 1.17				
Dimensions (L x W x H) mm	720 x 483 x 354 (8RU)	720 x 483 x 532 (12RU)	720 x 483 x 809 (16RU)	720 x 483 x 888 (20RU)	720 x 483 x 1066 (24RU)
Weight	≈ 34 kg	≈ 51 kg	≈ 68 kg	≈ 85 kg	≈ 102 kg
Environmental conditions	For limitations see „Environmental Conditions for Broadcast Products“.				

UHF Manifold Combiners

- Compact design as 19" slide-in unit (7RU per channel)
- Delivered in rack
- Installation in customer-owned rack on request
- Integrated mask filters for DTV
- Applicable within the whole UHF range
- For 6, 7 and 8 MHz channel bandwidth
- Temperature compensated

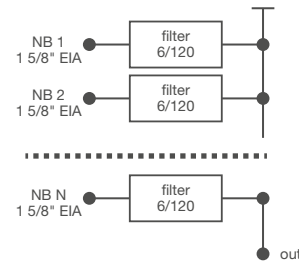
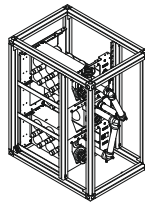

BN 578003C0001

Multi Channel Combiners

Part Number	BN 578002C0001 2 Inputs	BN 578003C0001 3 Inputs	BN 578004C0001 4 Inputs	BN 578005C0001 5 Inputs
Frequency range	470 - 700 MHz			
Narrowband input	1 5/8" EIA			
Filter type integrated cavities/size	6/120 ≡ BN 616663			
Temperature stability	≤ 2 kHz / K			
Harmonics attenuation	≥ 50 dB for f ≤ 500 MHz			
Standard	DVB-T @ 8 MHz, ($\hat{U}/U_{rms}=13$ dB)			
Average input power/channel width	1.6 kW per input for non-adjacent channels or 1.2 kW for adjacent channels			
Channel spacing	≥ 0 (pairs of adjacent channels possible)			
Tuning instruction AS6224	f_0	f_0	f_0	f_0
Insertion loss for non-adjacent channels	0.4-0.5 dB $f_0 \pm 3.805$ 0.9-1.2 dB $f_0 \pm 3.885$ 1.0-1.4 dB	0.4-0.7 dB $f_0 \pm 3.805$ 0.9-1.3 dB $f_0 \pm 3.885$ 1.1-1.5 dB	0.4-0.9 dB $f_0 \pm 3.805$ 0.9-1.5 dB $f_0 \pm 3.885$ 1.2-1.7 dB	0.4-1.0 dB $f_0 \pm 3.805$ 0.9-1.6 dB $f_0 \pm 3.885$ 1.2-1.7 dB
Mask filtering	$f_0 \pm 4.2$ ≥ 4 dB $f_0 \pm 6$ ≥ 20 dB $f_0 \pm 12$ ≥ 40 dB			
Group delay variation	$\Delta\tau \leq 350$ ns (at adjacent channel slopes: on request)			
Isolation between inputs	≥ 35 dB (for adjacent channels: on request)			
Standard	ISDB-T @ 6 MHz, ($\hat{U}/U_{rms}=13$ dB)			
Average input power/channel width	1.3 kW per input for non-adjacent channels or 1 kW for adjacent channels			
Channel spacing	≥ 0			
Tuning instruction AS6229	f_0	f_0	f_0	f_0
Insertion loss for non-adjacent channels	0.5-0.6 dB $f_0 \pm 2.79$ 1.2-1.5 dB	0.5-0.8 dB $f_0 \pm 2.79$ 1.2-1.7 dB	0.5-0.9 dB $f_0 \pm 2.79$ 1.2-1.8 dB	0.5-1.0 dB $f_0 \pm 2.79$ 1.2-1.9 dB
Mask filtering	$f_0 \pm 3$ ≥ 3 dB $f_0 \pm 3.15$ ≥ 5 dB $f_0 \pm 4.5$ ≥ 17 dB $f_0 \pm 9$ ≥ 38 dB $f_0 \pm 15$ ≥ 48 dB			
Group delay variation	$\Delta\tau \leq 450$ ns (at adjacent channel slopes: on request)			
Isolation between inputs	≥ 35 dB (for adjacent channels: on request)			
Standard	ATSC 1.0 @ 6 MHz, ($\hat{U}/U_{rms}=11$ dB)			
Average input power/channel width	1.3 kW per input for non-adjacent channels or 1 kW for adjacent channels			
Channel spacing	≥ 0			
Tuning instruction AS6228	f_0	f_0	f_0	f_0
Insertion loss for non-adjacent channels	0.5-0.65 dB $f_0 \pm 2.69$ 0.65-1.4 dB	0.5-0.85 dB $f_0 \pm 2.69$ 0.65-1.75 dB	0.5-0.95 dB $f_0 \pm 2.69$ 0.65-1.9 dB	0.5-1.1 dB $f_0 \pm 2.69$ 0.65-2.0 dB
Mask filtering	$f_0 \pm 3.5$ ≥ 3 dB $f_0 \pm 4$ ≥ 8 dB $f_0 \pm 6$ ≥ 30 dB $f_0 \pm 9$ ≥ 65 dB			
Group delay variation	$\Delta\tau \leq 250$ ns (at adjacent channel slopes: on request)			
Isolation between inputs	≥ 35 dB (for adjacent channels: on request)			
Output	1 5/8" EIA			
Average output power	7 kW			
Peak output voltage	8.5 kV			
VSWR	≤ 1.17 (≤ 1.20 for adjacent channels)			
Dimensions (L x W x H) mm	800 x 575 x 982	800 x 575 x 982	800 x 575 x 1560	800 x 575 x 1560
Weight	≈ 65 kg	≈ 94 kg	≈ 122 kg	≈ 150 kg
Environmental conditions	For limitations see „Environmental Conditions for Broadcast Products“.			

UHF Manifold Combiners

- Compact design as 19" slide-in unit (7RU per channel)
- Delivered in rack
- Installation in customer-owned rack on request
- Integrated mask filters for DTV
- Applicable within the whole UHF range
- For 6, 7 and 8 MHz channel bandwidth
- Temperature compensated

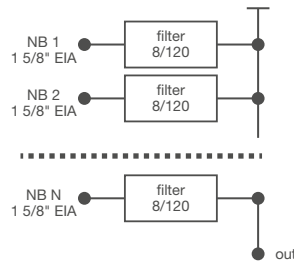
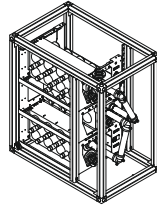

BN 578013C0001

Part Number	BN 578012C0001 2 Inputs	BN 578013C0001 3 Inputs	BN 578014C0001 4 Inputs	BN 578015C0001 5 Inputs
Frequency range	470 - 700 MHz			
Narrowband input	1 5/8" EIA			
Filter type integrated cavities/size	8/120 ≡ BN 616664			
Temperature stability	≤ 2 kHz / K			
Harmonics attenuation	≥ 50 dB for f ≤ 500 MHz			
Standard	DVB-T @ 8 MHz, ($\hat{U}/U_{rms}=13$ dB)			
Average input power/channel width	1.6 kW per input for non-adjacent channels or 1.2 kW for adjacent channels			
Channel spacing	≥ 0 (pairs of adjacent channels possible)			
Tuning instruction AS8112	f_0 0.5-0.6 dB	f_0 0.5-0.8 dB	f_0 5.1-1.0 dB	f_0 0.5-1.1 dB
Insertion loss for non-adjacent channels	$f_0 \pm 3.805$ 1.5-2.0 dB	$f_0 \pm 3.805$ 1.6-2.1 dB	$f_0 \pm 3.805$ 1.6-2.4 dB	$f_0 \pm 3.805$ 1.6-2.5 dB
	$f_0 \pm 3.885$ 1.6-2.4 dB	$f_0 \pm 3.885$ 1.7-2.5 dB	$f_0 \pm 3.885$ 1.7-2.8 dB	$f_0 \pm 3.885$ 1.7-2.9 dB
Mask filtering			$f_0 \pm 4.2$ ≥ 15 dB	
			$f_0 \pm 6$ ≥ 40 dB	
			$f_0 \pm 12$ ≥ 55 dB	
Group delay variation	$\Delta\tau \leq 550$ ns (at adjacent channel slopes: on request)			
Isolation between inputs	≥ 35 dB (for adjacent channels: on request)			
Standard	ISDB-T @ 6 MHz, ($\hat{U}/U_{rms}=13$ dB)			
Average input power/channel width	1.3 kW per input for non-adjacent channels or 1 kW for adjacent channels			
Channel spacing	≥ 0			
Tuning instruction AS8117	f_0 0.55-0.7 dB	f_0 0.55-0.9 dB	f_0 0.55-1.1 dB	f_0 1.05-1.2 dB
Insertion loss for non-adjacent channels	$f_0 \pm 2.79$ 1.3-1.8 dB	$f_0 \pm 2.79$ 1.4-1.9 dB	$f_0 \pm 2.79$ 1.4-2.2 dB	$f_0 \pm 2.79$ 1.4-2.3 dB
			$f_0 \pm 3.15$ ≥ 15 dB	
Mask filtering			$f_0 \pm 4.5$ ≥ 30 dB	
			$f_0 \pm 9$ ≥ 55 dB	
Group delay variation	$\Delta\tau \leq 600$ ns (at adjacent channel slopes: on request)			
Isolation between inputs	≥ 35 dB (for adjacent channels: on request)			
Standard	ATSC 1.0 @ 6 MHz, ($\hat{U}/U_{rms}=11$ dB)			
Average input power/channel width	1.3 kW per input for non-adjacent channels or 1 kW for adjacent channels			
Channel spacing	≥ 0			
Tuning instruction AS8115	f_0 0.6-0.7 dB	f_0 0.6-0.9 dB	f_0 0.6-1.1 dB	f_0 0.6-1.2 dB
Insertion loss for non-adjacent channels	$f_0 \pm 2.69$ 1.3-1.6 dB	$f_0 \pm 2.69$ 1.4-1.9 dB	$f_0 \pm 2.69$ 1.7-2.0 dB	$f_0 \pm 2.69$ 1.8-2.1 dB
			$f_0 \pm 3.5$ ≥ 4 dB	
Mask filtering			$f_0 \pm 3.25$ ≥ 18 dB	
			$f_0 \pm 9$ ≥ 64 dB	
Group delay variation	$\Delta\tau \leq 400$ ns (at adjacent channel slopes: on request)			
Isolation between inputs	≥ 35 dB (for adjacent channels: on request)			
Output	1 5/8" EIA			
Average output power	7 kW			
Peak output voltage	8.5 kV			
VSWR	≤ 1.17 (≤ 1.20 for adjacent channels)			
Dimensions (L x W x H) mm	900 x 575 x 982		900 x 575 x 1560	
Weight	≈ 70 kg	≈ 100 kg	≈ 130 kg	≈ 160 kg
Environmental conditions	For limitations see „Environmental Conditions for Broadcast Products“.			

UHF CIB Combiners

- 1 RU compact design as 19" slide-in unit
- Suitable for analogue and digital TV
- Tuneable within the whole UHF range
- For 6, 7 and 8 MHz channel bandwidth
- Temperature compensated
- Wall mount available

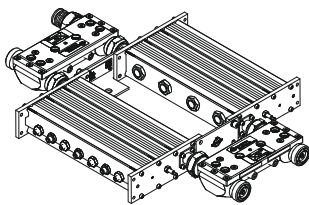
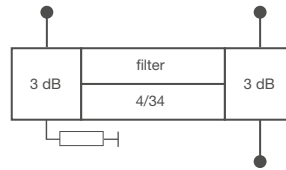

BN 578001

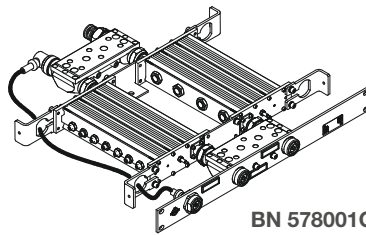

BN 578001C0001

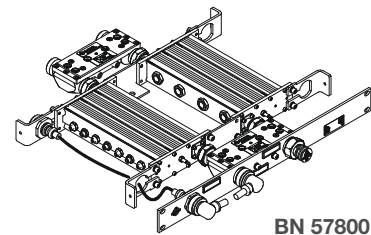

BN 578001C0002

Multi Channel Combiners

Part Number Front Plate Design	BN 578001 Without Front Plate	BN 578001C0001 Ports at Front Side	BN 578001C0002 Ports at Rear Side
Frequency range	470 - 800 MHz		
Channel spacing	≥ 1		
Narrowband input	7-16 female		
Filter type integrated cavities/size	4/34 ≡ BN 616507		
Temperature stability	≤ 10 kHz / K		
Harmonics attenuation	≥ 50 dB for f ≤ 1500 MHz		
DTV mask filtering	No		
Channel width	8 MHz ($\hat{U}/U_{rms}=13$ dB)	7 MHz ($\hat{U}/U_{rms}=13$ dB)	6 MHz ($\hat{U}/U_{rms}=11$ dB)
Average input power	≤ 100 W	≤ 90 W	≤ 80 W
Tuning instruction	AS4054	AS4046	AS4029
Insertion loss & mask filtering (alternative tuning on request)	470 MHz 860 MHz	470 MHz 803 MHz	470 MHz 803 MHz
f_0	≤ 0.8 dB ≤ 0.7 dB	f_0 ≤ 0.85 dB ≤ 0.75 dB	f_0 ≤ 0.9 dB ≤ 0.8 dB
$f_0 \pm 3.805$	≤ 0.9 dB ≤ 0.8 dB	$f_0 \pm 3.2$ ≤ 0.95 dB ≤ 0.85 dB	$f_0 \pm 2.885$ ≤ 1.0 dB ≤ 0.9 dB
$f_0 \pm 3.885$	≤ 0.9 dB ≤ 0.8 dB	$f_0 \pm 10.5$ ≥ 20 dB	$f_0 \pm 9$ ≤ 25 dB
$f_0 \pm 12$	≥ 17 dB		
Group delay variation	$\Delta\tau \leq 100$ ns	$\Delta\tau \leq 65$ ns	$\Delta\tau \leq 30$ ns
Wideband input	7-16 female		
Average input power	600 W		
	Attention: The power at the wideband input must be reduced by 50 % of the power fed into the narrowband input.		
DTV mask filtering	No		
Insertion loss	≤ 0.1 dB (non adjacent)		
Output	7-16 female		
Peak output voltage	1.6 kV		
Isolation between inputs	≥ 35 dB		
VSWR (one WB channel)	≤ 1.1		
Dimensions (L x W x H) mm	471 x 483 x 45 (1RU)		
Weight	≈ 5.5 kg		
Environmental conditions	For limitations see „Environmental Conditions for Broadcast Products“.		

UHF CIB Combiners

- Compact design as 19" slide-in unit
- For 6, 7 and 8 MHz channel bandwidth
- Integrated mask filters for DTV
- Adjacent channel operation
- Temperature compensated
- Tuneable within the whole UHF range

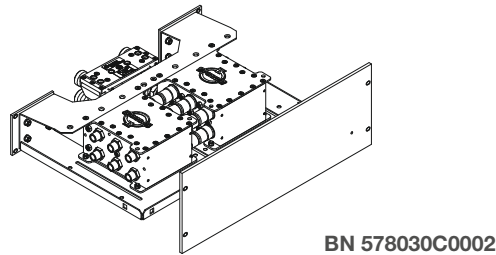
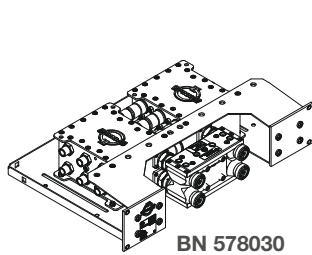
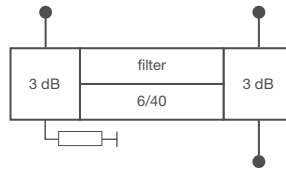

Part Number Front Plate Design	BN 578030 Without Front Plate		BN 578030C0002 With Front Plate and Ports at Rear Side	
Frequency range	470 - 800 MHz			
Channel spacing	≥ 0			
Narrowband input	7-16 female			
Filter type integrated cavities/size	6/40 ≡ BN 616660			
Temperature stability	≤ 2 kHz / K			
Harmonics attenuation	≥ 50 dB for f ≤ 1300 MHz			
DTV mask filtering	DVB-T @ 8 MHz ($\dot{U}/U_{rms}=13$ dB)	ISDB-T @ 6 MHz ($\dot{U}/U_{rms}=13$ dB)	ATSC 1.0 @ 6 MHz ($\dot{U}/U_{rms}=11$ dB)	
Average input power	≤ 260 W		≤ 200 W	
Tuning instruction	AS6361		AS6368	
Insertion loss & mask filtering (alternative tuning on request)	470 MHz	860 MHz	470 MHz	860 MHz
	f_0	f_0	f_0	f_0
	≤ 0.8 dB	≤ 1.0 dB	≤ 1.1 dB	≤ 1.4 dB
	$f_0 \pm 3.805$	≤ 2.0 dB	≤ 2.5 dB	$f_0 \pm 2.79$
	$f_0 \pm 3.885$	≤ 2.3 dB	≤ 2.8 dB	≤ 3.3 dB
	$f_0 \pm 4.2$	≥ 4 dB	$f_0 \pm 3.0$	≥ 4 dB
	$f_0 \pm 4.2$	≥ 4 dB	$f_0 \pm 3.15$	≥ 8 dB
	$f_0 \pm 6$	≥ 20 dB	$f_0 \pm 4.5$	≥ 22 dB
	$f_0 \pm 12$	≥ 40 dB	$f_0 \pm 9$	≥ 50 dB
			$f_0 \pm 15$	≥ 50 dB
			$f_0 \pm 3.25$	≥ 4 dB
			$f_0 \pm 3.5$	≥ 8 dB
			$f_0 \pm 4$	≥ 15 dB
			$f_0 \pm 6$	≥ 40 dB
			$f_0 \pm 9$	≥ 65 dB
Group delay variation	$\Delta\tau \leq 350$ ns		$\Delta\tau \leq 200$ ns	
Wideband input	7-16 female			
Average input power	1 kW			
	Attention: The power at the wideband input must be reduced by 50 % of the power fed into the narrowband input.			
DTV mask filtering	No			
Insertion loss	≤ 0.1 dB (non adjacent)			
Output	7-16 female			
Peak output voltage	≤ 2.8 kV			
Isolation between inputs	≥ 35 dB			
VSWR (one WB channel)	≤ 1.06			
Dimensions (L x W x H) mm	355 x 483 x 133 (3RU)			
Weight	≈ 12 kg			
Environmental conditions	For limitations see „Environmental Conditions for Broadcast Products“.			

UHF CIB Combiners

- Compact design as 19" slide-in unit
- For 6, 7 and 8 MHz channel bandwidth
- Integrated mask filters for DTV
- Adjacent channel operation
- Temperature compensated
- Tuneable within the whole UHF range

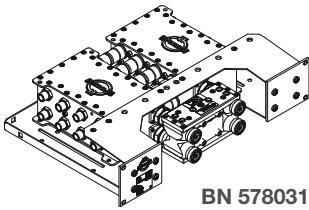
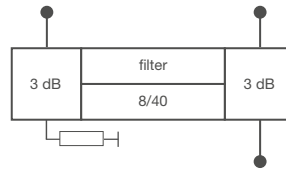

BN 578031

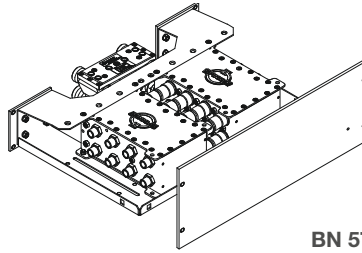

BN 578031C0002

Multi Channel Combiners

Part Number Front Plate Design	BN 578031 Without Front Plate		BN 578031C0002 With Front Plate and Ports at Rear Side	
Frequency range	470 - 800 MHz			
Channel spacing	≥ 0			
Narrowband input	7-16 female			
Filter type integrated cavities/size	8/40 ≡ BN 616661			
Temperature stability	≤ 2 kHz / K			
Harmonics attenuation	≥ 60 dB for f ≤ 1340 MHz			
DTV mask filtering	DVB-T @ 8 MHz ($\dot{U}/U_{rms}=13$ dB)	ISDB-T @ 6 MHz ($\dot{U}/U_{rms}=13$ dB)	ATSC 1.0 @ 6 MHz ($\dot{U}/U_{rms}=11$ dB)	
Average input power	≤ 240 W	≤ 200 W	≤ 200 W	
Tuning instruction	AS8131	AS8133	AS8132	
Insertion loss & mask filtering (alternative tuning on request)	470 MHz 860 MHz	470 MHz 860 MHz	470 MHz	860 MHz
	f_0 ≤ 1.2 dB ≤ 1.6 dB	f_0 ≤ 1.5 dB ≤ 1.85 dB	f_0 ≤ 1.6 dB	≤ 2.0 dB
	$f_0 \pm 3.805$ ≤ 3.7 dB ≤ 5.3 dB	$f_0 \pm 2.79$ ≤ 4.5 dB ≤ 5.1 dB	$f_0 \pm 2.69$ ≤ 3.9 dB	≤ 4.5 dB
	$f_0 \pm 3.885$ ≤ 4.5 dB ≤ 5.9 dB	$f_0 \pm 3.15$ ≥ 15 dB	$f_0 \pm 3$ ≥ 5 dB	
	$f_0 \pm 4.2$ ≥ 15 dB	$f_0 \pm 4.5$ ≥ 30 dB	$f_0 \pm 3.25$ ≥ 18 dB	
	$f_0 \pm 6$ ≥ 40 dB	$f_0 \pm 9$ ≥ 55 dB	$f_0 \pm 9$ ≥ 64 dB	
	$f_0 \pm 12$ ≥ 55 dB	$f_0 \pm 15$ ≥ 65 dB		
Group delay variation	$\Delta\tau \leq 600$ ns	$\Delta\tau \leq 500$ ns	$\Delta\tau \leq 400$ ns	
Wideband input	7-16 female			
Average input power	1 kW			
	Attention: The power at the wideband input must be reduced by 50 % of the power fed into the narrowband input.			
DTV mask filtering	No			
Insertion loss	≤ 0.1 dB (non adjacent)			
Output	7-16 female			
Peak output voltage	≤ 2.8 kV			
Isolation between inputs	≥ 35 dB			
VSWR (one WB channel)	≤ 1.06			
Dimensions (L x W x H) mm	355 x 483 x 133 (3RU)			
Weight	≈ 14 kg			
Environmental conditions	For limitations see „Environmental Conditions for Broadcast Products“.			

UHF CIB Combiners

- Compact design as 19" slide-in unit
- For 6, 7 and 8 MHz channel bandwidth
- Integrated mask filters for DTV
- Adjacent channel operation
- Temperature compensated
- Tuneable within the whole UHF range

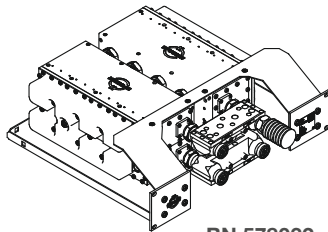
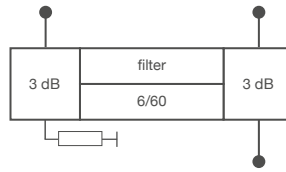

BN 578032

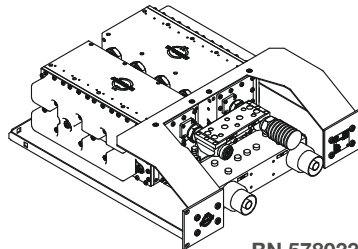

BN 578033

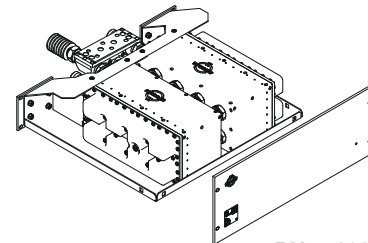

BN 578033C0002

Part Number Front Plate Design	BN 578032 Without Front Plate		BN 578033 Without Front Plate						
	BN 578032C0002 With Front Plate and Ports at Rear Side		BN 578033C0002 With Front Plate and Ports at Rear Side						
Frequency range	470 - 800 MHz								
Channel spacing	≥ 0								
Narrowband input	7-16 female								
Filter type integrated cavities/size	6/60 ≡ BN 616566								
Temperature stability	≤ 2 kHz / K								
Harmonics attenuation	≥ 50 dB for f ≤ 1200 MHz								
DTV mask filtering	DVB-T @ 8 MHz (Û/U _{rms} =13 dB)	ISDB-T @ 6 MHz (Û/U _{rms} =13 dB)	ATSC 1.0 @ 6 MHz (Û/U _{rms} =11 dB)						
Average input power	≤ 750 W		≤ 600 W	≤ 600 W					
Tuning instruction	AS6201		AS6192	AS6257					
Insertion loss & mask filtering (alternative tuning on request)	470 MHz	860 MHz	470 MHz	803 MHz	470 MHz	803 MHz			
	f ₀	≤ 0.55 dB	≤ 0.65 dB	f ₀	≤ 0.7 dB	≤ 0.85 dB	f ₀	≤ 0.8 dB	≤ 1.1 dB
	f ₀ ± 3.805	≤ 1.35 dB	≤ 1.85 dB	f ₀ ± 2.79	≤ 1.7 dB	≤ 2.30 dB	f ₀ ± 2.69	≤ 1.5 dB	≤ 1.8 dB
	f ₀ ± 3.885	≤ 1.55 dB	≤ 2.10 dB	f ₀ ± 3.0	≥ 4 dB		f ₀ ± 3.0	≤ 2.7 dB	≤ 2.8 dB
	f ₀ ± 4.2	≥ 4 dB		f ₀ ± 3.15	≥ 8 dB		f ₀ ± 3.25	≥ 4 dB	
	f ₀ ± 6	≥ 20 dB		f ₀ ± 4.5	≥ 23 dB		f ₀ ± 4	≥ 15 dB	
	f ₀ ± 12	≥ 40 dB		f ₀ ± 9	≥ 48 dB		f ₀ ± 6	≥ 40 dB	
			f ₀ ± 15	≥ 50 dB		f ₀ ± 9	≥ 65 dB		
Group delay variation	Δτ ≤ 350 ns		Δτ ≤ 350 ns		Δτ ≤ 200 ns				
Wideband input	7-16 female		1 5/8" SMS unflanged						
Average input power	≤ 1.1 kW		≤ 4 kW						
DTV mask filtering			No						
Insertion loss			≤ 0.1 dB (non adjacent)						
Output	7-16 female		1 5/8" SMS unflanged						
Peak output voltage	≤ 2.8 kV		≤ 6 kV						
Isolation between inputs			≥ 35 dB						
VSWR (one WB channel)			≤ 1.06						
Dimensions (L x W x H) mm	482 x 483 x 177 (4RU)		510 x 483 x 177 (4RU)						
Weight	≈ 17 kg		≈ 20 kg						
Environmental conditions	For limitations see „Environmental Conditions for Broadcast Products“.								

UHF CIB Combiners

- Compact design as 19" slide-in unit
- For 6, 7 and 8 MHz channel bandwidth
- Integrated mask filters for DTV
- Adjacent channel operation
- Temperature compensated
- Tuneable within the whole UHF range

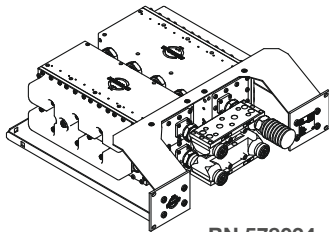
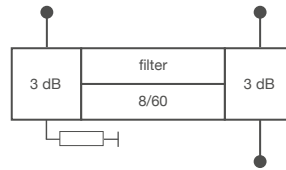

BN 578034

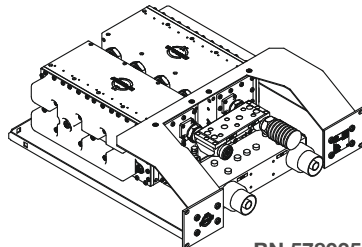

BN 578035

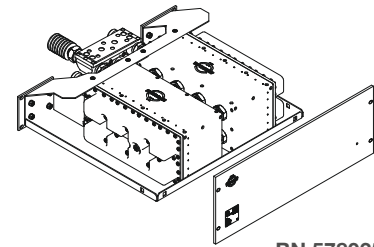

BN 578035 C0002

Multi Channel Combiners

Part Number Front Plate Design	BN 578034 Without Front Plate		BN 578035 Without Front Plate	
	BN 578034C0002 With Front Plate and Ports at Rear Side		BN 578035C0002 With Front Plate and Ports at Rear Side	
Frequency range	470 - 800 MHz			
Channel spacing	≥ 0			
Narrowband input	7-16 female			
Filter type integrated cavities/size	8/60 ≡ BN 616568			
Temperature stability	≤ 2 kHz / K			
Harmonics attenuation	≥ 50 dB for f ≤ 1200 MHz			
DTV mask filtering	DVB-T @ 8 MHz ($\dot{U}/U_{rms}=13$ dB)	ISDB-T @ 6 MHz ($\dot{U}/U_{rms}=13$ dB)	ATSC 1.0 @ 6 MHz ($\dot{U}/U_{rms}=11$ dB)	
Average input power	≤ 750 W		≤ 600 W	
Tuning instruction	AS8087		AS8095 AS8084	
Insertion loss & mask filtering (alternative tuning on request)	470 MHz	860 MHz	470 MHz	803 MHz
	f_0 ≤ 0.75 dB	≤ 1.00 dB	f_0 ≤ 0.85 dB	≤ 1.15 dB
	$f_0 \pm 3.805$ ≤ 2.35 dB	≤ 3.15 dB	$f_0 \pm 2.79$ ≤ 2.25 dB	≤ 3.10 dB
	$f_0 \pm 3.885$ ≤ 3.05 dB	≤ 3.85 dB	$f_0 \pm 3.15$ ≥ 15 dB	$f_0 \pm 3.0$ ≥ 3 dB
	$f_0 \pm 4.2$ ≥ 15 dB		$f_0 \pm 4.5$ ≥ 30 dB	$f_0 \pm 3.25$ ≥ 18 dB
	$f_0 \pm 6$ ≥ 40 dB		$f_0 \pm 9$ ≥ 55 dB	$f_0 \pm 9$ ≥ 64 dB
	$f_0 \pm 12$ ≥ 55 dB			
Group delay variation	$\Delta\tau \leq 660$ ns		$\Delta\tau \leq 500$ ns	
Wideband input	7-16 female		1 5/8" SMS unflanged	
Average input power	≤ 1.1 kW		≤ 4 kW	
	Attention: The power at the wideband input must be reduced by 50 % of the power fed into the narrowband input.			
DTV mask filtering	No			
Insertion loss	≤ 0.1 dB (non adjacent)			
Output	7-16 female		1 5/8" SMS unflanged	
Peak output voltage	≤ 2.8 kV		≤ 6 kV	
Isolation between inputs	≥ 35 dB			
VSWR (one WB channel)	≤ 1.06			
Dimensions (L x W x H) mm	482 x 483 x 177 (4RU)		510 x 483 x 177 (4RU)	
Weight	≈ 20 kg		≈ 22 kg	
Environmental conditions	For limitations see „Environmental Conditions for Broadcast Products“.			

UHF CIB Combiners

- Compact design as 19" slide-in unit
- Suitable for analogue and digital TV
- For 6, 7 and 8 MHz channel bandwidth
- Temperature compensated
- Tuneable within the whole UHF range

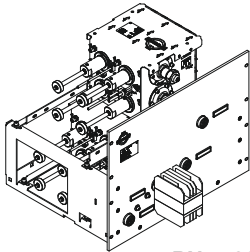
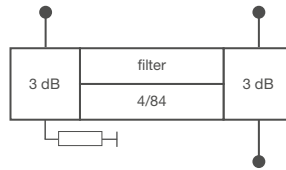

BN 578036C0001

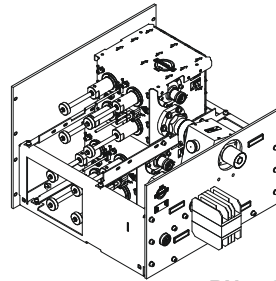

BN 578037C0002

Part Number Front Plate Design	BN 578036C0001 With Ports at Front Plate	BN 578037C0001 With Ports at Front Plate																											
	BN 578036C0002 With Ports at Rear Side	BN 578037C0002 With Ports at Rear Side																											
Frequency range	470 - 800 MHz																												
Channel spacing	≥ 1																												
Narrowband input	7-16 female																												
Filter type integrated cavities/size	4/84 ≡ BN 616400																												
Temperature stability	≤ 2 kHz / K																												
Harmonics attenuation	≥ 45 dB for f ≤ 950 MHz																												
DTV mask filtering	No																												
Channel width	8 MHz ($\hat{U}/U_{rms}=13$ dB)	6 MHz ($\hat{U}/U_{rms}=13$ dB)																											
Average input power	≤ 1.5 kW	≤ 1.5 kW																											
Tuning instruction	AS4055	AS4038																											
Insertion loss (alternative tuning on request)	<table border="0"> <tr> <td></td> <td>470 MHz</td> <td>860 MHz</td> </tr> <tr> <td>f_0</td> <td>≤ 0.40 dB</td> <td>≤ 0.45 dB</td> </tr> <tr> <td>$f_0 \pm 3.805$</td> <td>≤ 0.50 dB</td> <td>≤ 0.60 dB</td> </tr> <tr> <td>$f_0 \pm 3.885$</td> <td>≤ 0.50 dB</td> <td>≤ 0.60 dB</td> </tr> <tr> <td>$f_0 \pm 12$</td> <td colspan="2">≥ 28 dB</td> </tr> </table>		470 MHz	860 MHz	f_0	≤ 0.40 dB	≤ 0.45 dB	$f_0 \pm 3.805$	≤ 0.50 dB	≤ 0.60 dB	$f_0 \pm 3.885$	≤ 0.50 dB	≤ 0.60 dB	$f_0 \pm 12$	≥ 28 dB		<table border="0"> <tr> <td></td> <td>470 MHz</td> <td>860 MHz</td> </tr> <tr> <td>f_0</td> <td>≤ 0.45 dB</td> <td>≤ 0.55 dB</td> </tr> <tr> <td>$f_0 \pm 3$</td> <td>≤ 0.60 dB</td> <td>≤ 0.75 dB</td> </tr> <tr> <td>$f_0 \pm 9$</td> <td colspan="2">≥ 30 dB</td> </tr> </table>		470 MHz	860 MHz	f_0	≤ 0.45 dB	≤ 0.55 dB	$f_0 \pm 3$	≤ 0.60 dB	≤ 0.75 dB	$f_0 \pm 9$	≥ 30 dB	
	470 MHz	860 MHz																											
f_0	≤ 0.40 dB	≤ 0.45 dB																											
$f_0 \pm 3.805$	≤ 0.50 dB	≤ 0.60 dB																											
$f_0 \pm 3.885$	≤ 0.50 dB	≤ 0.60 dB																											
$f_0 \pm 12$	≥ 28 dB																												
	470 MHz	860 MHz																											
f_0	≤ 0.45 dB	≤ 0.55 dB																											
$f_0 \pm 3$	≤ 0.60 dB	≤ 0.75 dB																											
$f_0 \pm 9$	≥ 30 dB																												
Group delay variation	$\Delta\tau \leq 90$ ns	$\Delta\tau \leq 100$ ns																											
Wideband input	7-16 female	1 5/8" SMS unflanged																											
Average input power	≤ 1.1 kW	≤ 7 kW																											
	Attention: The power at the wideband input must be reduced by 50 % of the power fed into the narrowband input.																												
DTV mask filtering	No																												
Insertion loss	≤ 0.1 dB (non adjacent)																												
Output	7-16 female	1 5/8" SMS unflanged																											
Average output power	-	≤ 7 kW																											
Peak output voltage	≤ 2.8 kV	≤ 8.5 kV																											
Isolation between inputs	≥ 35 dB																												
VSWR (one WB channel)	≤ 1.06																												
Dimensions (L x W x H) mm	503 x 483 x 355 (8RU)	560 x 483 x 355 (8RU)																											
Weight	≈ 20 kg	≈ 25 kg																											
Environmental conditions	For limitations see „Environmental Conditions for Broadcast Products“.																												

CCS UHF CIB Combiners

- **CCS** compact design
- Suitable for analogue and digital TV
- For 6, 7 and 8 MHz channel bandwidth
- Temperature compensated
- Tuneable within the whole UHF range

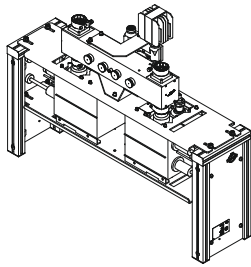
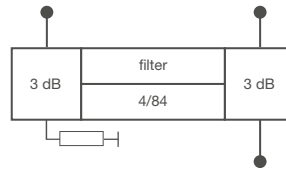

BN 576001C0002
with rack

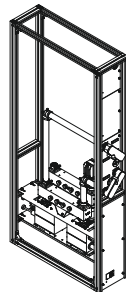

BN 576002
inside switching rack

Multi Channel Combiners

Part Number	BN 576001C0002	BN 576002C0002
Frequency range	470 - 800 MHz	
Channel spacing	≥ 1	
Narrowband input	7-16 female	1 5/8" EIA
Filter type integrated cavities/size	4/84 ≡ BN 616400	
Temperature stability	≤ 2 kHz / K	
Harmonics attenuation	≥ 45 dB for f ≤ 950 MHz	
DTV mask filtering	No	
Channel width	8 MHz ($\dot{U}/U_{rms}=13$ dB)	6 MHz ($\dot{U}/U_{rms}=13$ dB)
Average input power	≤ 1.5 kW BN 576001C0002 ≤ 2.5 kW BN 576002C0002	
Tuning instruction	AS4055	AS4038
Insertion loss (alternative tuning on request)	470 MHz 860 MHz f_0 ≤ 0.4 dB ≤ 0.45 dB $f_0 \pm 3.805$ ≤ 0.5 dB ≤ 0.6 dB $f_0 \pm 3.885$ ≤ 0.5 dB ≤ 0.6 dB $f_0 \pm 12$ ≥ 28 dB	470 MHz 860 MHz f_0 ≤ 0.45 dB ≤ 0.55 dB $f_0 \pm 3$ ≤ 0.60 dB ≤ 0.75 dB $f_0 \pm 9$ ≥ 30 dB
Group delay variation	$\Delta\tau \leq 90$ ns	$\Delta\tau \leq 100$ ns
Wideband input	1 5/8" EIA	
Average input power	≤ 7 kW	
	Attention: The power at the wideband input must be reduced by 50 % of the power fed into the narrowband input.	
DTV mask filtering	No	
Insertion loss	≤ 0.1 dB (non adjacent)	
Output	1 5/8" SMS unflanged	
Average output power	≤ 7 kW	
Peak output voltage	≤ 8.5 kV	
Isolation between inputs	≥ 35 dB	
VSWR (one WB channel)	≤ 1.06	
Dimensions (L x W x H) mm	900 x 226 x 660	900 x 226 x 965
Weight	≈ 30 kg	≈ 40 kg
Environmental conditions	For limitations see „Environmental Conditions for Broadcast Products“.	

UHF CIB Combiners

- Compact design as 19" slide-in unit
- Integrated mask filters for DTV
- Adjacent channel operation
- For 6, 7 and 8 MHz channel bandwidth
- Temperature compensated
- Tuneable within the whole UHF range

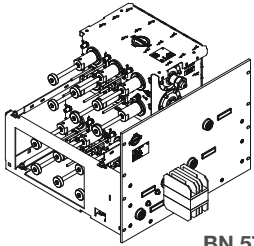
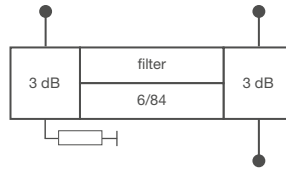

BN 578038C0001

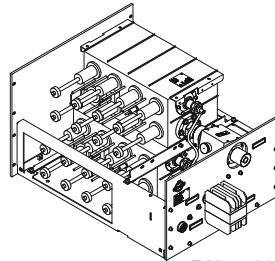

BN 578039C0002

Part Number Front Plate Design	BN 578038C0001 With Ports at Front Plate		BN 578039C0001 With Ports at Front Plate						
	BN 578038C0002 With Ports at Rear Side		BN 578039C0002 With Ports at Rear Side						
Frequency range	470 - 800 MHz								
Channel spacing	≥ 0								
Narrowband input	7-16 female								
Filter type integrated cavities/size	6/84 ≡ BN 616402								
Temperature stability	≤ 2 kHz / K								
Harmonics attenuation	≥ 50 dB for f ≤ 950 MHz								
DTV mask filtering	DVB-T @ 8 MHz ($\dot{U}/U_{rms}=13$ dB)	ISDB-T @ 6 MHz ($\dot{U}/U_{rms}=13$ dB)	ATSC 1.0 @ 6 MHz ($\dot{U}/U_{rms}=11$ dB)						
Average input power	≤ 1.5 kW	≤ 1.2 kW	≤ 1.2 kW						
Tuning instruction	AS6186	AS6182	AS6156						
Insertion loss & mask filtering (alternative tuning on request)	470 MHz	860 MHz	470 MHz	803 MHz	470 MHz	803 MHz			
	f_0	≤ 0.5 dB	≤ 0.6 dB	f_0	≤ 0.6 dB	≤ 0.8 dB	f_0	≤ 0.7 dB	≤ 0.9 dB
	$f_0 \pm 3.805$	≤ 1.2 dB	≤ 1.5 dB	$f_0 \pm 2.79$	≤ 1.6 dB	≤ 2.2 dB	$f_0 \pm 2.69$	≤ 1.1 dB	≤ 1.55 dB
	$f_0 \pm 3.885$	≤ 1.3 dB	≤ 1.6 dB	$f_0 \pm 3.0$	≥ 4 dB		$f_0 \pm 3.0$	≤ 1.9 dB	≤ 2.45 dB
	$f_0 \pm 4.2$	≥ 4 dB		$f_0 \pm 3.15$	≥ 8 dB		$f_0 \pm 3.25$	≥ 4 dB	
	$f_0 \pm 6$	≥ 20 dB		$f_0 \pm 4.5$	≥ 24 dB		$f_0 \pm 3.5$	≥ 8 dB	
	$f_0 \pm 12$	≥ 40 dB		$f_0 \pm 9$	≥ 48 dB		$f_0 \pm 4$	≥ 15 dB	
				$f_0 \pm 15$	≥ 50 dB		$f_0 \pm 6$	≥ 40 dB	
						$f_0 \pm 9$	≥ 65 dB		
Group delay variation	$\Delta\tau \leq 330$ ns		$\Delta\tau \leq 500$ ns		$\Delta\tau \leq 200$ ns				
Wideband input	7-16 female		1 5/8" SMS unflanged						
Average input power	≤ 1.1 kW		≤ 7 kW						
	Attention: The power at the wideband input must be reduced by 50 % of the power fed into the narrowband input.								
DTV mask filtering	No								
Insertion loss	≤ 0.1 dB (non adjacent)								
Output	7-16 female		1 5/8" SMS unflanged						
Average output power	-		≤ 7 kW						
Peak output voltage	≤ 2.8 kV		≤ 8.5 kV						
Isolation between inputs	≥ 35 dB								
VSWR (one WB channel)	≤ 1.06								
Dimensions (L x W x H) mm	586 x 483 x 355 (8RU)								
Weight	≈ 30 kg		≈ 32 kg						
Environmental conditions	For limitations see „Environmental Conditions for Broadcast Products“.								

CCS UHF CIB Combiners

- **CCS** compact design
- Integrated mask filters for DTV
- Adjacent channel operation
- For 6, 7 and 8 MHz channel bandwidth
- Temperature compensated
- Tuneable within the whole UHF range

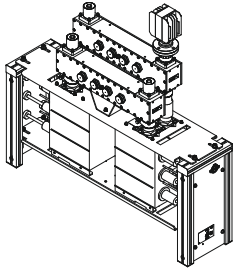
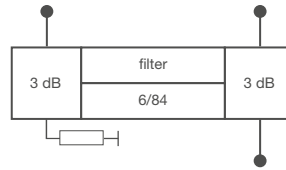

BN 576005C0002 with rack

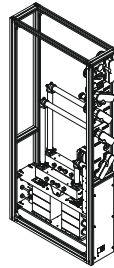

BN 576005 inside switching rack

Multi Channel Combiners

Part Number	BN 576004C0002		BN 576005C0002						
Frequency range	470 - 800 MHz								
Channel spacing	≥ 0								
Narrowband input	7-16 female		1 5/8" EIA						
Filter type integrated cavities/size	6/84 ≡ BN 616402								
Temperature stability	≤ 2 kHz / K								
Harmonics attenuation	≥ 50 dB for f ≤ 950 MHz								
DTV mask filtering	DVB-T @ 8 MHz ($\dot{U}/U_{rms}=13$ dB)	ISDB-T @ 6 MHz ($\dot{U}/U_{rms}=13$ dB)	ATSC 1.0 @ 6 MHz ($\dot{U}/U_{rms}=11$ dB)						
Average input power	≤ 1.5 kW		≤ 1.2 kW						
Tuning instruction	AS6186		AS6182						
Insertion loss & mask filtering (alternative tuning on request)	470 MHz	860 MHz	470 MHz	803 MHz	470 MHz	803 MHz			
	f_0	≤ 0.5 dB	≤ 0.6 dB	f_0	≤ 0.6 dB	≤ 0.8 dB	f_0	≤ 0.7 dB	≤ 0.9 dB
	$f_0 \pm 3.805$	≤ 1.2 dB	≤ 1.5 dB	$f_0 \pm 2.79$	≤ 1.6 dB	≤ 2.2 dB	$f_0 \pm 2.69$	≤ 1.1 dB	≤ 1.55 dB
	$f_0 \pm 3.885$	≤ 1.3 dB	≤ 1.6 dB	$f_0 \pm 3.0$	≥ 4 dB		$f_0 \pm 3.0$	≤ 1.9 dB	≤ 2.45 dB
	$f_0 \pm 4.2$	≥ 4 dB		$f_0 \pm 3.15$	≥ 8 dB		$f_0 \pm 3.25$	≥ 4 dB	
	$f_0 \pm 6$	≥ 20 dB		$f_0 \pm 4.5$	≥ 23 dB		$f_0 \pm 3.5$	≥ 8 dB	
	$f_0 \pm 12$	≥ 40 dB		$f_0 \pm 9$	≥ 48 dB		$f_0 \pm 4$	≥ 15 dB	
				$f_0 \pm 15$	≥ 50 dB		$f_0 \pm 6$	≥ 40 dB	
						$f_0 \pm 9$	≥ 65 dB		
Group delay variation	$\Delta\tau \leq 330$ ns		$\Delta\tau \leq 500$ ns		$\Delta\tau \leq 200$ ns				
Wideband input	1 5/8" EIA								
Average input power	≤ 7 kW								
	Attention: The power at the wideband input must be reduced by 50 % of the power fed into the narrowband input.								
DTV mask filtering	No								
Insertion loss	≤ 0.1 dB (non adjacent)								
Output	1 5/8" EIA								
Average output power	≤ 7 kW								
Peak output voltage	≤ 8.5 kV								
Isolation between inputs	≥ 35 dB								
VSWR (one WB channel)	≤ 1.06								
Dimensions (L x W x H) mm	900 x 226 x 665		900 x 226 x 965						
Weight	≈ 30 kg		≈ 40 kg						
Environmental conditions	For limitations see „Environmental Conditions for Broadcast Products“.								

UHF CIB Combiners

- Compact design as 19" slide-in unit
- Integrated mask filters for DTV
- Adjacent channel operation
- For 6, 7 and 8 MHz channel bandwidth
- Temperature compensated
- Tuneable within the whole UHF range

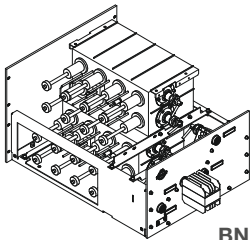
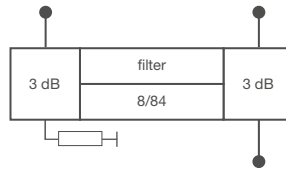

BN 578040C0002

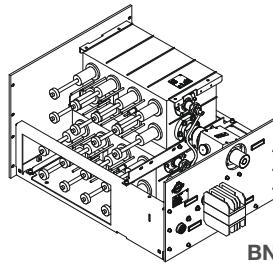

BN 578041C0002

Part Number Front Plate Design	BN 578040C0001 With Ports at Front Plate		BN 578041C0001 With Ports at Front Plate						
	BN 578040C0002 With Ports at Rear Side		BN 578041C0002 With Ports at Rear Side						
Frequency range	470 - 800 MHz								
Channel spacing	≥ 0								
Narrowband input	7-16 female								
Filter type integrated cavities/size	8/84 ≡ BN 616403								
Temperature stability	≤ 2 kHz / K								
Harmonics attenuation	≥ 50 dB for f ≤ 950 MHz								
DTV mask filtering	DVB-T @ 8 MHz ($\dot{U}/U_{rms}=13$ dB)	ISDB-T @ 6 MHz ($\dot{U}/U_{rms}=13$ dB)	ATSC 1.0 @ 6 MHz ($\dot{U}/U_{rms}=11$ dB)						
Average input power	≤ 1.5 kW	≤ 1.2 kW	≤ 1.2 kW						
Tuning instruction	AS8068	AS8091	AS8051						
Insertion loss & mask filtering (alternative tuning on request)	470 MHz	860 MHz	470 MHz	803 MHz	470 MHz	803 MHz			
	f_0	≤ 0.6 dB	≤ 0.75 dB	f_0	≤ 0.7 dB	≤ 1.3 dB	f_0	≤ 0.9 dB	≤ 1.3 dB
	$f_0 \pm 3.805$	≤ 1.8 dB	≤ 2.2 dB	$f_0 \pm 2.79$	≤ 1.8 dB	≤ 3.1 dB	$f_0 \pm 2.69$	≤ 1.9 dB	≤ 2.7 dB
	$f_0 \pm 3.885$	≤ 2.1 dB	≤ 2.6 dB	$f_0 \pm 3.15$	≥ 15 dB		$f_0 \pm 3.0$	≥ 3 dB	
	$f_0 \pm 4.2$	≥ 15 dB		$f_0 \pm 4.5$	≥ 30 dB		$f_0 \pm 3.25$	≥ 18 dB	
	$f_0 \pm 6$	≥ 40 dB		$f_0 \pm 9$	≥ 55 dB		$f_0 \pm 9$	≥ 64 dB	
	$f_0 \pm 12$	≥ 55 dB							
Group delay variation	$\Delta\tau \leq 600$ ns		$\Delta\tau \leq 500$ ns		$\Delta\tau \leq 400$ ns				
Wideband input	7-16 female		1 5/8" SMS unflanged						
Average input power	≤ 1.1 kW		≤ 7 kW						
DTV mask filtering	No								
Insertion loss	≤ 0.1 dB (non adjacent)								
Output	7-16 female		1 5/8" SMS unflanged						
Average output power	-		≤ 7 kW						
Peak output voltage	≤ 2.8 kV		≤ 8.5 kV						
Isolation between inputs	≥ 35 dB								
VSWR (one WB channel)	≤ 1.06								
Dimensions (L x W x H) mm	600 x 483 x 355								
Weight	≈ 35 kg		≈ 40 kg						
Environmental conditions	For limitations see „Environmental Conditions for Broadcast Products“.								

CCS UHF CIB Combiners

- **CCS** compact design
- Integrated mask filters for DTV
- Adjacent channel operation
- For 6, 7 and 8 MHz channel bandwidth
- Temperature compensated
- Tuneable within the whole UHF range

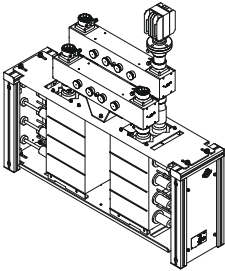
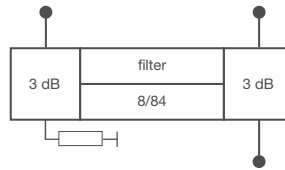

BN 576008C0002
with rack

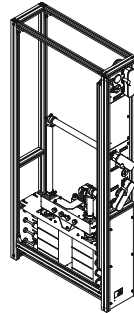

BN 576007
inside switching rack

Multi Channel
Combiners

Part Number	BN 576007C0002		BN 576008C0002	
Frequency range	470 - 800 MHz			
Channel spacing	≥ 0			
Narrowband input	7-16 female		1 5/8" EIA	
Filter type integrated cavities/size	8/84 ≡ BN 616403			
Temperature stability	≤ 2 kHz / K			
Harmonics attenuation	≥ 50 dB for f ≤ 950 MHz			
DTV mask filtering	DVB-T @ 8 MHz ($\dot{U}/U_{rms}=13$ dB)	ISDB-T @ 6 MHz ($\dot{U}/U_{rms}=13$ dB)	ATSC 1.0 @ 6 MHz ($\dot{U}/U_{rms}=11$ dB)	
Average input power	≤ 1.5 kW		≤ 1.2 kW	≤ 1.2 kW
Tuning instruction	AS8068		AS8091	AS8051
Insertion loss & mask filtering (alternative tuning on request)	470 MHz 860 MHz	470 MHz 803 MHz	470 MHz 803 MHz	470 MHz 803 MHz
	f_0 ≤ 0.6 dB ≤ 0.75 dB	f_0 ≤ 0.7 dB ≤ 1.3 dB	f_0 ≤ 0.9 dB ≤ 1.3 dB	f_0 ≤ 0.9 dB ≤ 1.3 dB
	$f_0 \pm 3.805$ ≤ 1.8 dB ≤ 2.2 dB	$f_0 \pm 2.79$ ≤ 1.8 dB ≤ 3.1 dB	$f_0 \pm 2.69$ ≤ 1.9 dB ≤ 2.7 dB	$f_0 \pm 2.69$ ≤ 1.9 dB ≤ 2.7 dB
	$f_0 \pm 3.885$ ≤ 2.1 dB ≤ 2.6 dB	$f_0 \pm 3.15$ ≥ 15 dB	$f_0 \pm 3.0$ ≤ 3 dB	$f_0 \pm 3.0$ ≤ 3 dB
	$f_0 \pm 4.2$ ≥ 15 dB	$f_0 \pm 4.5$ ≥ 30 dB	$f_0 \pm 3.25$ ≥ 18 dB	$f_0 \pm 3.25$ ≥ 18 dB
	$f_0 \pm 6$ ≥ 40 dB	$f_0 \pm 9$ ≥ 55 dB	$f_0 \pm 9$ ≥ 64 dB	$f_0 \pm 9$ ≥ 64 dB
	$f_0 \pm 12$ ≥ 55 dB			
Group delay variation	$\Delta\tau$ ≤ 600 ns		$\Delta\tau$ ≤ 500 ns	$\Delta\tau$ ≤ 400 ns
Wideband input	1 5/8" EIA			
Average input power	≤ 7 kW			
	Attention: The power at the wideband input must be reduced by 50 % of the power fed into the narrowband input.			
DTV mask filtering	No			
Insertion loss	≤ 0.1 dB (non adjacent)			
Output	1 5/8" SMS unflanged			
Average output power	≤ 7 kW			
Peak output voltage	≤ 8.5 kV			
Isolation between inputs	≥ 35 dB			
VSWR (one WB channel)	≤ 1.06			
Dimensions (L x W x H) mm	900 x 226 x 665		900 x 226 x 965	
Weight	≈ 35 kg		≈ 45 kg	
Environmental conditions	For limitations see „Environmental Conditions for Broadcast Products“.			

CCS UHF CIB Combiners

- **CCS** compact design
- Integrated mask filters for DTV
- Adjacent channel operation
- For 6, 7 and 8 MHz channel bandwidth
- Temperature compensated
- Tuneable within the whole UHF range

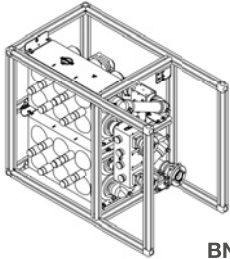
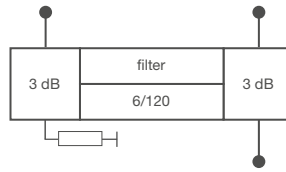

BN 578011A0070

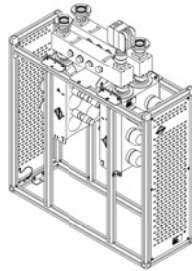

BN 576012A0040

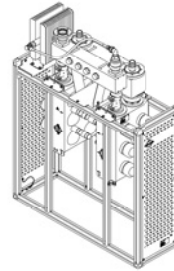

BN 576013A0040

Part Number/Size	BN 578011A0070 19"	BN 576012A0030 700 BN 576012A0040 900	BN 576013A0030 700 BN 576013A0040 900
Frequency range	470 - 800 MHz		
Channel spacing	≥ 0		
Narrowband input	1 5/8" EIA		
Filter type integrated cavities/size	6/120 ≡ BN 616663		
Temperature stability	≤ 2 kHz / K		
Harmonics attenuation	≥ 50 dB for f ≤ 1100 MHz		
DTV mask filtering	DVB-T @ 8 MHz (Ü/U _{rms} =13 dB)	ISDB-T @ 6 MHz (Ü/U _{rms} =13 dB)	ATSC 1.0 @ 6 MHz (Ü/U _{rms} =11 dB)
Average input power	≤ 3.2 kW	≤ 2.6 kW	≤ 2.6 kW
Tuning instruction	AS6224	AS6229	AS6228
Insertion loss & mask filtering (alternative tuning on request)	470 MHz 860 MHz	470 MHz 803 MHz	470 MHz 803 MHz
	f ₀ ≤ 0.4 dB ≤ 0.5 dB	f ₀ ≤ 0.45 dB ≤ 0.6 dB	f ₀ ≤ 0.50 dB ≤ 0.65 dB
	f ₀ ± 3.805 ≤ 0.9 dB ≤ 1.2 dB	f ₀ ± 2.79 ≤ 1.20 dB ≤ 1.5 dB	f ₀ ± 2.69 ≤ 0.65 dB ≤ 1.40 dB
	f ₀ ± 3.885 ≤ 1.0 dB ≤ 1.4 dB	f ₀ ± 3.0 ≥ 3 dB	f ₀ ± 3.5 ≥ 3 dB
	f ₀ ± 4.2 ≥ 4 dB	f ₀ ± 3.15 ≥ 5 dB	f ₀ ± 4 ≥ 8 dB
	f ₀ ± 6 ≥ 20 dB	f ₀ ± 4.5 ≥ 17 dB	f ₀ ± 6 ≥ 30 dB
	f ₀ ± 12 ≥ 40 dB	f ₀ ± 9 ≥ 38 dB	f ₀ ± 9 ≥ 65 dB
Group delay variation	Δτ ≤ 350 ns	f ₀ ± 15 ≥ 48 dB Δτ ≤ 450 ns	Δτ ≤ 250 ns
Wideband input	1 5/8" EIA		3 1/8" EIA male
Average input power	≤ 7 kW		≤ 17.5 kW
	Attention: The power at the wideband input must be reduced by 50 % of the power fed into the narrowband input.		
DTV mask filtering	No		
Insertion loss	≤ 0.1 dB (non adjacent)		
Output	1 5/8" EIA		3 1/8" EIA male
Peak output voltage	≤ 8.5 kV		≤ 12.5 kV
Average output power	≤ 7 kW		-
Isolation between inputs	≥ 35 dB		
VSWR (one WB channel)	≤ 1.06		
Dimensions (L x W x H) mm	800 x 448 x 617	BN 576012A0030, BN 576013A0030: 700 x 315 x 1200 BN 576012A0040, BN 576013A0040: 900 x 315 x 1200	
Weight	≈ 70 kg		≈ 80 kg
Environmental conditions	For limitations see „Environmental Conditions for Broadcast Products“.		

CCS UHF CIB Combiners

- **CCS** compact design
- Integrated mask filters for DTV
- Adjacent channel operation
- For 6, 7 and 8 MHz channel bandwidth
- Temperature compensated
- Tuneable within the whole UHF range

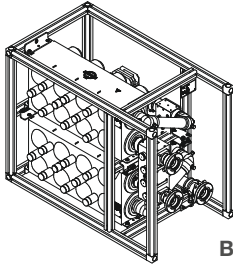
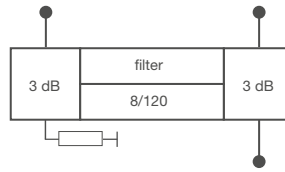

BN 578010A0070

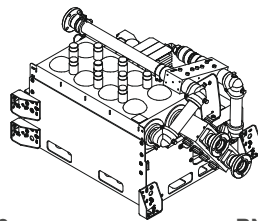

BN 578010A0075

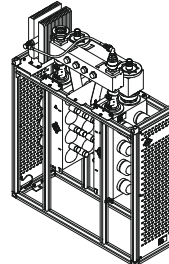

BN 576017A0040

Multi Channel Combiners

Part Number/Size	BN 578010A0070 BN 578010A0075	448 570	BN 576016A0030 BN 576016A0040	700 900	BN 576017A0030 BN 576017A0040	700 900
Frequency range	470 - 800 MHz					
Channel spacing	≥ 0					
Narrowband input	1 5/8" EIA					
Filter type integrated cavities/size	8/120 ≡ BN 616664					
Temperature stability	≤ 2 kHz / K					
Harmonics attenuation	≥ 50 dB for f ≤ 1100 MHz					
DTV mask filtering	DVB-T @ 8 MHz ($\dot{U}/U_{rms}=13$ dB)		ISDB-T @ 6 MHz ($\dot{U}/U_{rms}=13$ dB)		ATSC 1.0 @ 6 MHz ($\dot{U}/U_{rms}=11$ dB)	
Average input power	≤ 3.2 kW		≤ 2.6 kW		≤ 2.6 kW	
Tuning instruction	AS8112		AS8117		AS8115	
Insertion loss & mask filtering (alternative tuning on request)	470 MHz 860 MHz		470 MHz 803 MHz		470 MHz 803 MHz	
	f_0	≤ 0.5 dB ≤ 0.6 dB	f_0	≤ 0.55 dB ≤ 0.7 dB	f_0	≤ 0.6 dB ≤ 0.7 dB
	$f_0 \pm 3.805$	≤ 1.5 dB ≤ 1.8 dB	$f_0 \pm 2.79$	≤ 1.30 dB ≤ 1.8 dB	$f_0 \pm 2.69$	≤ 1.3 dB ≤ 1.6 dB
	$f_0 \pm 3.885$	≤ 1.6 dB ≤ 2.0 dB	$f_0 \pm 3.15$	≥ 15 dB	$f_0 \pm 3$	≥ 4 dB
	$f_0 \pm 4.2$	≥ 15 dB	$f_0 \pm 4.5$	≥ 30 dB	$f_0 \pm 3.25$	≥ 18 dB
	$f_0 \pm 6$	≥ 40 dB	$f_0 \pm 9$	≥ 55 dB	$f_0 \pm 9$	≥ 64 dB
	$f_0 \pm 12$	≥ 55 dB				
Group delay variation	$\Delta\tau \leq 550$ ns		$\Delta\tau \leq 600$ ns		$\Delta\tau \leq 400$ ns	
Wideband input	1 5/8" EIA				3 1/8" EIA male	
Average input power	≤ 7 kW				≤ 17.5 kW	
	Attention: The power at the wideband input must be reduced by 50 % of the power fed into the narrowband input.					
DTV mask filtering	No					
Insertion loss	≤ 0.1 dB (non adjacent)					
Output	1 5/8" EIA				3 1/8" EIA male	
Peak output voltage	≤ 8.5 kV				≤ 12.5 kV	
Average output power	≤ 7 kW				-	
Isolation between inputs	≥ 35 dB					
VSWR (one WB channel)	≤ 1.06					
Dimensions (L x W x H) mm	BN 575515A0070: 800x448x617 BN 575515A0075: 800x570x389		BN 576016A0030, BN 576017A0030: 700 x 315 x 1200 BN 576016A0040, BN 576017A0040: 900 x 315 x 1200			
Weight	≈ 75 kg		≈ 80 kg		≈ 90 kg	
Environmental conditions	For limitations see „Environmental Conditions for Broadcast Products“.					

CCS UHF CIB Combiners

- **CCS** compact design
- For 6, 7 and 8 MHz channel bandwidth
- Temperature compensated
- Tuneable within the whole UHF range

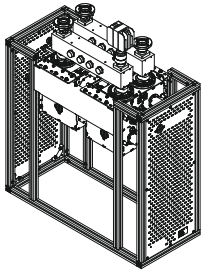
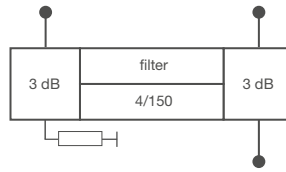

BN 576030A0000

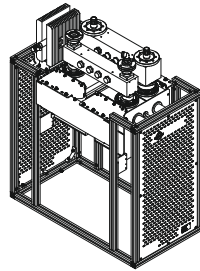

BN 576031A0010

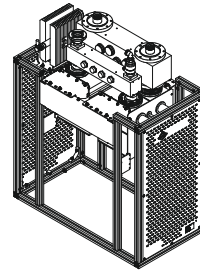

BN 576032A0010

Part Number	BN 576030A0000	BN 576031A0010	BN 576032A0010
Frequency range		470 - 800 MHz	
Channel spacing		≥ 1	
Narrowband input		1 5/8" EIA	
Filter type integrated cavities/size		4/150 ≡ BN 616404	
Temperature stability		≤ 2 kHz / K	
Harmonics attenuation		≥ 40 dB for f ≤ 860 MHz	
DTV mask filtering		No	
Channel width	8 MHz ($\hat{U}/U_{rms}=13$ dB)		6 MHz ($\hat{U}/U_{rms}=13$ dB)
Average input power	≤ 7 kW ATV ≤ 5 kW DTV		≤ 7 kW ATV ≤ 5 kW DTV
Tuning instruction	AS4005		AS4034
Insertion loss (alternative tuning on request)		470 MHz 860 MHz f_0 ≤ 0.30 dB ≤ 0.35 dB $f_0 \pm 3.885$ ≤ 0.35 dB ≤ 0.40 dB $f_0 \pm 12$ ≥ 12 dB	470 MHz 803 MHz f_0 ≤ 0.35 dB ≤ 0.45 dB $f_0 \pm 3.0$ ≤ 0.45 dB ≤ 0.50 dB
Group delay variation	$\Delta\tau \leq 30$ ns		$\Delta\tau \leq 40$ ns
Wideband input	1 5/8" EIA	3 1/8" EIA male	4 1/2" EIA male
Average input power	≤ 7 kW	≤ 17.5 kW	≤ 33 kW
	Attention: The power at the wideband input must be reduced by 50 % of the power fed into the narrowband input.		
DTV mask filtering		No	
Insertion loss		≤ 0.1 dB (non adjacent)	
Output	1 5/8" EIA	3 1/8" EIA male	4 1/2" EIA male
Peak output voltage	≤ 8.5 kV	≤ 12.5 kV	≤ 15.5 kV
Average output power	≤ 7 kW	–	–
Isolation between inputs		≥ 35 dB	
VSWR (one WB channel)		≤ 1.06	
Dimensions (L x W x H) mm	900 x 390 x 1200	900 x 480 x 1200	900 x 480 x 1200
Weight	≈ 80 kg	≈ 90 kg	≈ 100 kg
Environmental conditions	For limitations see „Environmental Conditions for Broadcast Products“.		

CCS UHF CIB Combiners

- **CCS** compact design
- Integrated mask filters for ATSC
- For 6 MHz channel bandwidth
- Temperature compensated
- Tuneable within the whole UHF range

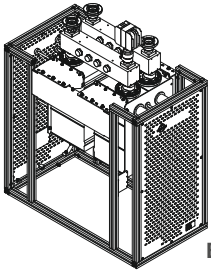
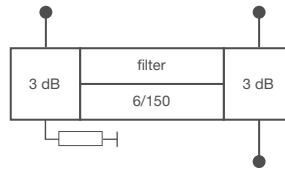

BN 576090A0010

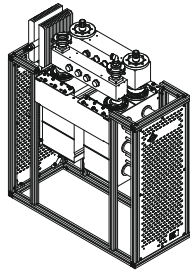

BN 576091A0000

Multi Channel Combiners

Part Number	BN 576090A0010	BN 576091A0000																					
Frequency range	470 - 800 MHz																						
Channel spacing	≥ 1																						
Narrowband input	1 5/8" EIA																						
Filter type integrated cavities/size	6/150 ≡ BN 616572																						
Temperature stability	≤ 2 kHz / K																						
Harmonics attenuation	≥ 50 dB for f ≤ 860 MHz																						
DTV mask filtering	ATSC 1.0 @ 6 MHz ($\dot{U}/U_{rms}=11$ dB)																						
Average input power	≤ 4.5 kW																						
Tuning instruction	AS6081																						
Insertion loss & mask filtering (alternative tuning on request)	<table border="0"> <tr> <td></td> <td>470 MHz</td> <td>860 MHz</td> </tr> <tr> <td>f_0</td> <td>≤ 0.5 dB</td> <td>≤ 0.6 dB</td> </tr> <tr> <td>$f_0 \pm 3.805$</td> <td>≤ 1.5 dB</td> <td>≤ 1.8 dB</td> </tr> <tr> <td>$f_0 \pm 3.885$</td> <td>≤ 1.6 dB</td> <td>≤ 2.0 dB</td> </tr> <tr> <td>$f_0 \pm 4.2$</td> <td colspan="2">≥ 15 dB</td> </tr> <tr> <td>$f_0 \pm 6$</td> <td colspan="2">≥ 40 dB</td> </tr> <tr> <td>$f_0 \pm 12$</td> <td colspan="2">≥ 55 dB</td> </tr> </table>			470 MHz	860 MHz	f_0	≤ 0.5 dB	≤ 0.6 dB	$f_0 \pm 3.805$	≤ 1.5 dB	≤ 1.8 dB	$f_0 \pm 3.885$	≤ 1.6 dB	≤ 2.0 dB	$f_0 \pm 4.2$	≥ 15 dB		$f_0 \pm 6$	≥ 40 dB		$f_0 \pm 12$	≥ 55 dB	
	470 MHz	860 MHz																					
f_0	≤ 0.5 dB	≤ 0.6 dB																					
$f_0 \pm 3.805$	≤ 1.5 dB	≤ 1.8 dB																					
$f_0 \pm 3.885$	≤ 1.6 dB	≤ 2.0 dB																					
$f_0 \pm 4.2$	≥ 15 dB																						
$f_0 \pm 6$	≥ 40 dB																						
$f_0 \pm 12$	≥ 55 dB																						
Group delay variation	$\Delta\tau \leq 200$ ns																						
Wideband input	1 5/8" EIA	3 1/8" EIA male																					
Average input power	≤ 7 kW	≤ 17.5 kW																					
	Attention: The power at the wideband input must be reduced by 50 % of the power fed into the narrowband input.																						
DTV mask filtering	No																						
Insertion loss	≤ 0.1 dB (non adjacent)																						
Output	1 5/8" EIA	3 1/8" EIA male																					
Peak output voltage	≤ 8.5 kV	≤ 12.5 kV																					
Average output power	≤ 7 kW	-																					
Isolation between inputs	≥ 35 dB																						
VSWR (one WB channel)	≤ 1.06																						
Dimensions (L x W x H) mm	900 x 480 x 1200	900 x 390 x 1200																					
Weight	≈ 95 kg	≈ 105 kg																					
Environmental conditions	For limitations see „Environmental Conditions for Broadcast Products“.																						

CCS UHF CIB Combiners

- **CCS** compact design
- Integrated mask filters for DTV
- Adjacent channel operation
- For 6, 7 and 8 MHz channel bandwidth
- Temperature compensated
- Tuneable within the whole UHF range

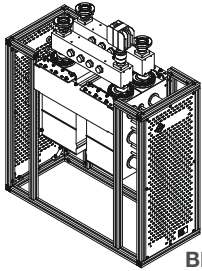
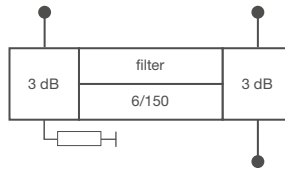

BN 576036A0000

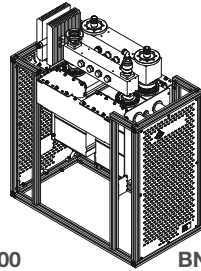

BN 576034A0000

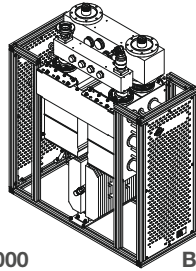

BN 576035A0000

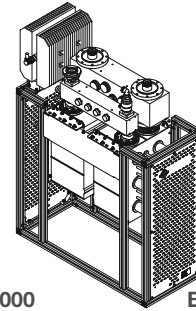

BN 576035A0010

Part Number/Size	BN 576036A0000 390		BN 576034A0000 390		BN 576035A0000 390				
	BN 576036A0010 480		BN 576034A0010 480		BN 576035A0010 480				
Frequency range	470 - 800 MHz								
Channel spacing	≥ 0								
Narrowband input	1 5/8" EIA								
Filter type integrated cavities/size	6/150 ≡ BN 616518								
Temperature stability	≤ 2 kHz / K								
Harmonics attenuation	≥ 50 dB for f ≤ 860 MHz								
DTV mask filtering	DVB-T @ 8 MHz (Ü/U _{rms} =13 dB)		ISDB-T @ 6 MHz (Ü/U _{rms} =13 dB)		DVB-T @ 7 MHz (Ü/U _{rms} =13 dB)				
Average input power	≤ 5 kW		≤ 4 kW		≤ 4.5 kW				
Tuning instruction	AS6193		AS6184		AS6289				
Insertion loss & mask filtering (alternative tuning on request)	470 MHz	860 MHz	470 MHz	803 MHz	470 MHz	820 MHz			
	f ₀	≤ 0.40 dB	≤ 0.55 dB	f ₀	≤ 0.5 dB	≤ 0.7 dB	f ₀	≤ 0.45 dB	≤ 0.6 dB
	f ₀ ± 3.805	≤ 0.85 dB	≤ 1.3 dB	f ₀ ± 2.79	≤ 1.2 dB	≤ 1.6 dB	f ₀ ± 3.2	≤ 0.65 dB	≤ 0.95 dB
	f ₀ ± 3.885	≤ 1.05 dB	≤ 1.5 dB	f ₀ ± 3.0	≥ 3.5 dB		f ₀ ± 4.2	≥ 13 dB	
	f ₀ ± 4.2	≥ 4 dB		f ₀ ± 3.15	≥ 8 dB		f ₀ ± 10.5	≥ 38 dB	
	f ₀ ± 6	≥ 20 dB		f ₀ ± 4.5	≥ 23 dB				
	f ₀ ± 12	≥ 40 dB		f ₀ ± 9	≥ 48 dB				
			f ₀ ± 15	≥ 50 dB					
Group delay variation	Δτ ≤ 350 ns		Δτ ≤ 500 ns		Δτ ≤ 150 ns				
Wideband input	1 5/8" EIA		3 1/8" EIA male		4 1/2" EIA male				
Average input power	≤ 7 kW		≤ 17.5 kW		≤ 33 kW				
	Attention: The power at the wideband input must be reduced by 50 % of the power fed into the narrowband input.								
DTV mask filtering	No								
Insertion loss	≤ 0.1 dB (non adjacent)								
Output	1 5/8" EIA		3 1/8" EIA male		4 1/2" EIA male				
Peak output voltage	≤ 8.5 kV		≤ 12.5 kV		≤ 15.5 kV				
Average output power	≤ 7 kW		-		-				
Isolation between inputs	≥ 35 dB								
VSWR (one WB channel)	≤ 1.06								
Dimensions (L x W x H) mm	BN 576036A0000, BN 576034A0000, BN 576035A0000: 900 x 390 x 1200 BN 576036A0010, BN 576034A0010, BN 576035A0010: 900 x 480 x 1200								
Weight	≈ 90 kg		≈ 100 kg		≈ 115 kg				
Environmental conditions	For limitations see „Environmental Conditions for Broadcast Products“.								

CCS UHF CIB Combiners

- **CCS** compact design
- Integrated mask filters for DTV
- Adjacent channel operation
- For 6, 7 and 8 MHz channel bandwidth
- Temperature compensated
- Tuneable within the whole UHF range

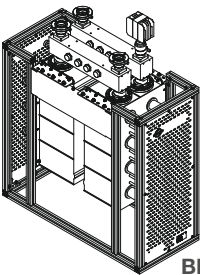
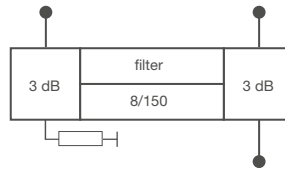

BN 576037A0000

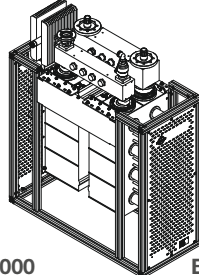

BN 576038A0000

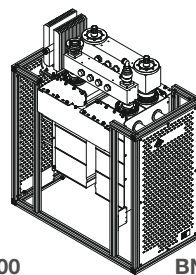

BN 576038A0010

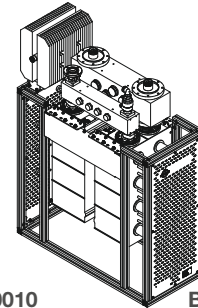

BN 576039A0000

Multi Channel Combiners

Part Number/Size	BN 576037A0000	390	BN 576038A0000	390	BN 576039A0000	390
	BN 576037A0010	480	BN 576038A0010	480	BN 576039A0010	480
Frequency range	470 - 800 MHz					
Channel spacing	≥ 0					
Narrowband input	1 5/8" EIA					
Filter type integrated cavities/size	8/150 ≡ BN 616542					
Temperature stability	≤ 2 kHz / K					
Harmonics attenuation	≥ 50 dB for f ≤ 860 MHz					
DTV mask filtering	DVB-T @ 8 MHz (Ü/U _{rms} =13 dB)		ISDB-T @ 6 MHz (Ü/U _{rms} =13 dB)		ATSC 1.0 @ 6 MHz (Ü/U _{rms} =11 dB)	
Average input power	≤ 4 kW		≤ 3.2 kW		≤ 3.2 kW	
Tuning instruction	AS8071		AS8096		AS8094	
Insertion loss & mask filtering (alternative tuning on request)	470 MHz	860 MHz	470 MHz	803 MHz	470 MHz	806 MHz
	f ₀	≤ 0.5 dB	≤ 0.75 dB	f ₀	≤ 0.6 dB	≤ 0.80 dB
	f ₀ ± 3.805	≤ 1.6 dB	≤ 2.2 dB	f ₀ ± 2.79	≤ 1.4 dB	≤ 1.85 dB
	f ₀ ± 3.885	≤ 1.8 dB	≤ 2.5 dB	f ₀ ± 3.15	≥ 15 dB	f ₀ ± 3.00
	f ₀ ± 4.2	≥ 15 dB		f ₀ ± 4.5	≥ 30 dB	f ₀ ± 3.25
	f ₀ ± 6	≥ 40 dB		f ₀ ± 9	≥ 55 dB	f ₀ ± 9
	f ₀ ± 12	≥ 55 dB				
Group delay variation	Δτ ≤ 700 ns		Δτ ≤ 500 ns		Δτ ≤ 400 ns	
Wideband input	1 5/8" EIA		3 1/8" EIA male		4 1/2" EIA male	
Average input power	≤ 7 kW		≤ 17.5 kW		≤ 33 kW	
	Attention: The power at the wideband input must be reduced by 50 % of the power fed into the narrowband input.					
DTV mask filtering	No					
Insertion loss	≤ 0.1 dB (non adjacent)					
Output	1 5/8" EIA		3 1/8" EIA male		4 1/2" EIA male	
Peak output voltage	≤ 8.5 kV		≤ 12.5 kV		≤ 15.5 kV	
Average output power	≤ 7 kW		-		-	
Isolation between inputs	≥ 35 dB					
VSWR (one WB channel)	≤ 1.06					
Dimensions (L x W x H) mm	BN 576037A0000, BN 576038A0000, BN 576039A0000: 900 x 390 x 1200 BN 576037A0010, BN 576038A0010, BN 576039A0010: 900 x 480 x 1200					
Weight	≈ 105 kg		≈ 120 kg		≈ 135 kg	
Environmental conditions	For limitations see „Environmental Conditions for Broadcast Products“.					

CCS UHF CIB Combiners

- **CCS** compact design
- Integrated mask filters for ATSC
- For 6 MHz channel bandwidth
- Temperature compensated
- Tuneable within the whole UHF range

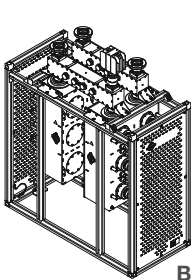
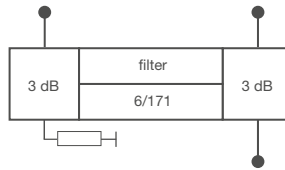

BN 578042A0060

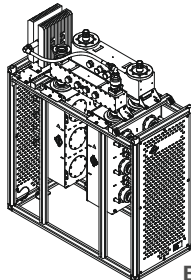

BN 578043A0060

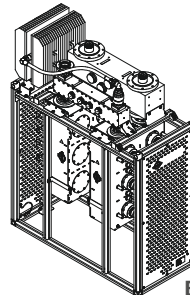

BN 578044A0060

Part Number/Size	BN 578042A0010 480 BN 578042A0060 415	BN 578043A0010 480 BN 578043A0060 415	BN 578044A0010 480 BN 578044A0060 415
Frequency range	470 - 700 MHz		
Channel spacing	≥ 1		
Narrowband input	1 5/8" EIA		
Filter type integrated cavities/size	6/171 ≡ BN 616577		
Temperature stability	≤ 2 kHz / K		
Harmonics attenuation	≥ 67 dB for f ≤ 800 MHz		
DTV mask filtering	ATSC 1.0 @ 6 MHz (Ü/U _{rms} = 11 dB)		ATSC 3.0 @ 6 MHz (Ü/U _{rms} = 13 dB)
Average input power	≤ 6 kW		
Tuning instruction	AS6585		
Insertion loss & mask filtering (alternative tuning on request)		470 MHz 700 MHz	
		f ₀ ≤ 0.50 dB ≤ 0.60 dB	
		f ₀ ± 2.69 ≤ 0.70 dB ≤ 0.75 dB	
		f ₀ ± 2.92 ≤ 0.85 dB ≤ 0.95 dB	
		f ₀ ± 3.5 ≥ 3 dB	
		f ₀ ± 3.15 ≥ 8 dB	
		f ₀ ± 6 ≥ 30 dB	
		f ₀ ± 9 ≥ 65 dB	
Group delay variation	Δτ ≤ 200 ns		
Wideband input	1 5/8" EIA	3 1/8" EIA male	4 1/2" EIA male
Average input power	≤ 7 kW	≤ 17.5 kW	≤ 33 kW
	Attention: The power at the wideband input must be reduced by 50 % of the power fed into the narrowband input.		
DTV mask filtering	No		
Insertion loss	≤ 0.1 dB (non adjacent)		
Output	1 5/8" EIA	3 1/8" EIA male	4 1/2" EIA male
Peak output voltage	≤ 8.5 kV	≤ 12.5 kV	≤ 15.5 kV
Average output power	≤ 7 kW	-	-
Isolation between inputs	≥ 35 dB		
VSWR (one WB channel)	≤ 1.06		
Dimensions (L x W x H) mm	BN 578042A0010, BN 578043A0010, BN 578044A0010: 900 x 480 x 1200 BN 578042A0060, BN 578043A0060, BN 578044A0060: 900 x 415 x 1200		
Weight	≈ 96 kg	≈ 100 kg	≈ 120 kg
Environmental conditions	For limitations see „Environmental Conditions for Broadcast Products“.		

CCS UHF CIB Combiners

- **CCS** compact design
- Integrated mask filters for DTV
- Adjacent channel operation
- For 6, 7 and 8 MHz channel bandwidth
- Temperature compensated
- Tuneable within the whole UHF range

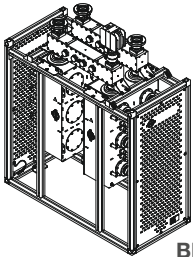
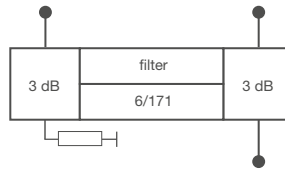

BN 578020A0060

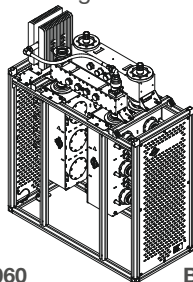

BN 578021A0060

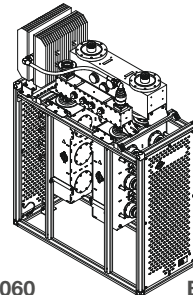

BN 578022A0060

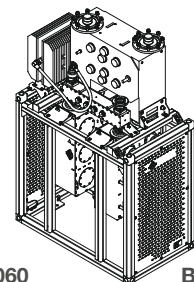

BN 578023A0020

Multi Channel Combiners

Part Number/Size	BN 578020A0010 480 BN 578020A0060 415	BN 578021A0010 480 BN 578021A0060 415	BN 578022A0010 480 BN 578022A0060 415	BN 578023A0020 520
Frequency range	470 - 700 MHz			
Channel spacing	≥ 0			
Narrowband input	1 5/8" EIA			
Filter type integrated cavities/size	6/171 ≡ BN 616576			
Temperature stability	≤ 2 kHz / K			
Harmonics attenuation	≥ 50 dB for f ≤ 1000 MHz			
DTV mask filtering	DVB-T @ 8 MHz ($\dot{U}/U_{rms}=13$ dB)		ISDB-T @ 6 MHz ($\dot{U}/U_{rms}=13$ dB)	
Average input power	≤ 7 kW		≤ 6 kW	
Tuning instruction	AS6548		AS6549	
Insertion loss & mask filtering (alternative tuning on request)	470 MHz 700 MHz		470 MHz 700 MHz	
	f_0	≤ 0.35 dB ≤ 0.45 dB	f_0	≤ 0.50 dB ≤ 0.60 dB
	$f_0 \pm 3.805$	≤ 0.85 dB ≤ 1.00 dB	$f_0 \pm 2.79$	≤ 1.15 dB ≤ 1.35 dB
	$f_0 \pm 3.885$	≤ 1.00 dB ≤ 1.10 dB	$f_0 \pm 3.0$	≥ 3 dB
	$f_0 \pm 4.2$	≥ 4 dB	$f_0 \pm 3.15$	≥ 5 dB
	$f_0 \pm 6$	≥ 20 dB	$f_0 \pm 4.5$	≥ 17 dB
	$f_0 \pm 12$	≥ 40 dB	$f_0 \pm 9$	≥ 38 dB
			$f_0 \pm 15$	≥ 48 dB
Group delay variation	$\Delta\tau \leq 350$ ns		$\Delta\tau \leq 400$ ns	
Wideband input	1 5/8" EIA	3 1/8" EIA male	4 1/2" EIA male	52-120 BT male
Average input power	≤ 7 kW	≤ 17.5 kW	≤ 33 kW	≤ 60 kW
	Attention: The power at the wideband input must be reduced by 50 % of the power fed into the narrowband input.			
DTV mask filtering	No			
Insertion loss	≤ 0.1 dB (non adjacent)			
Output	1 5/8" EIA	3 1/8" EIA male	4 1/2" EIA male	52-120 BT male
Peak output voltage	≤ 8.5 kV	≤ 12.5 kV	≤ 15.5 kV	≤ 19.5 kV
Average output power	≤ 7 kW	-	-	≤ 60 kW
Isolation between inputs	≥ 35 dB			
VSWR (one WB channel)	≤ 1.06			
Dimensions (L x W x H) mm	BN 578020A0010, BN 578021A0010, BN 578022A0010: 900 x 480 x 1200 BN 578020A0060, BN 578021A0060, BN 578022A0060: 900 x 415 x 1200			900 x 520 x 1400
Weight	≈ 95 kg	≈ 100 kg	≈ 120 kg	≈ 160 kg
Environmental conditions	For limitations see „Environmental Conditions for Broadcast Products“.			

CCS UHF CIB Combiners

- **CCS** compact design
- Integrated mask filters for DTV
- Adjacent channel operation
- For 6, 7 and 8 MHz channel bandwidth
- Temperature compensated
- Tuneable within the whole UHF range

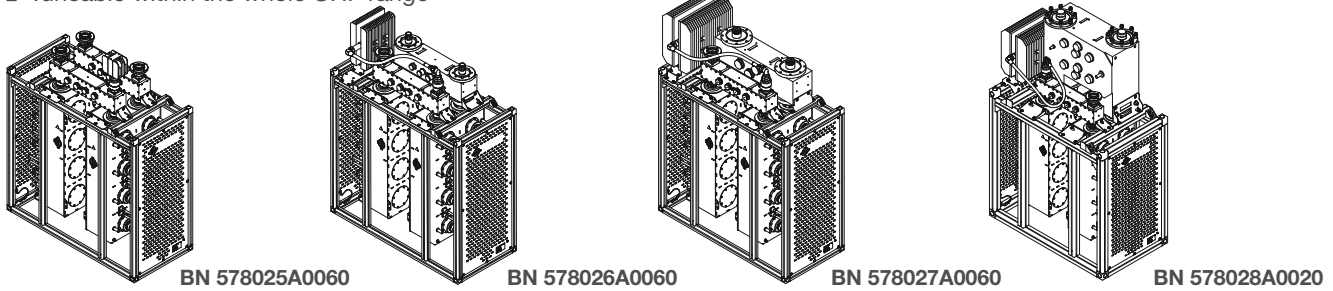
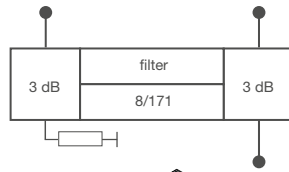

Part Number/Size	BN 578025A0010 480 BN 578025A0060 415	BN 578026A0010 480 BN 578026A0060 415	BN 578027A0010 480 BN 578027A0060 415	BN 578028A0020 520					
Frequency range	470 - 700 MHz								
Channel spacing	≥ 0								
Narrowband input	1 5/8" EIA								
Filter type integrated cavities/size	8/171 ≡ BN 616578								
Temperature stability	≤ 2 kHz / K								
Harmonics attenuation	≥ 50 dB for f ≤ 1000 MHz								
DTV mask filtering	DVB-T @ 8 MHz (Ü/U _{rms} =13 dB)	ISDB-T @ 6 MHz (Ü/U _{rms} =13 dB)	ATSC 1.0 @ 6 MHz (Ü/U _{rms} =11 dB)						
Average input power	≤ 6 kW	≤ 4.8 kW	≤ 4.8 kW						
Tuning instruction	AS8182	AS8183	AS8184						
Insertion loss & mask filtering (alternative tuning on request)	470 MHz	700 MHz	470 MHz	700 MHz	470 MHz	700 MHz			
	f ₀	≤ 0.45 dB	≤ 0.55 dB	f ₀	≤ 0.50 dB	≤ 0.6 dB	f ₀	≤ 0.55 dB	≤ 0.65 dB
	f ₀ ± 3.805	≤ 1.20 dB	≤ 1.90 dB	f ₀ ± 2.79	≤ 1.40 dB	≤ 1.8 dB	f ₀ ± 2.69	≤ 1.15 dB	≤ 1.50 dB
	f ₀ ± 3.885	≤ 1.50 dB	≤ 2.10 dB	f ₀ ± 3.15	≥ 12 dB		f ₀ ± 3	≥ 4 dB	
	f ₀ ± 4.2	≥ 15 dB		f ₀ ± 4.5	≥ 28 dB		f ₀ ± 3.25	≥ 18 dB	
	f ₀ ± 6	≥ 40 dB		f ₀ ± 9	≥ 54 dB		f ₀ ± 9	≥ 64 dB	
f ₀ ± 12	≥ 55 dB								
Group delay variation	Δτ ≤ 700 ns		Δτ ≤ 650 ns		Δτ ≤ 500 ns				
Wideband input	1 5/8" EIA	3 1/8" EIA male	4 1/2" EIA male	52-120 BT male					
Average input power	≤ 7 kW	≤ 17.5 kW	≤ 33 kW	≤ 60 kW					
	Attention: The power at the wideband input must be reduced by 50 % of the power fed into the narrowband input.								
DTV mask filtering	No								
Insertion loss	≤ 0.1 dB (non adjacent)								
Output	1 5/8" EIA	3 1/8" EIA male	4 1/2" EIA male	52-120 BT male					
Peak output voltage	≤ 8.5 kV	≤ 12.5 kV	≤ 15.5 kV	≤ 19.5 kV					
Average output power	≤ 7 kW	-	-	≤ 60 kW					
Isolation between inputs	≥ 35 dB								
VSWR (one WB channel)	≤ 1.06								
Dimensions (L x W x H) mm	BN 578025A0010, BN 578026A0010, BN 578027A0010: 900 x 480 x 1200 BN 578025A0060, BN 578026A0060, BN 578027A0060: 900 x 415 x 1200			900 x 520 x 1400					
Weight	≈ 115 kg	≈ 120 kg	≈ 140 kg	≈ 180 kg					
Environmental conditions	For limitations see „Environmental Conditions for Broadcast Products“.								

CCS UHF CIB Combiners

- **CCS** compact design
- For 6, 7 and 8 MHz channel bandwidth
- Temperature compensated
- Tuneable within the whole UHF range

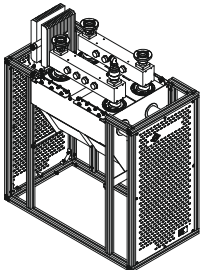
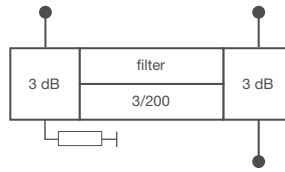

BN 576040A0010

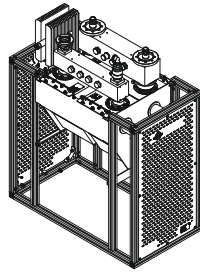

BN 576041A0010

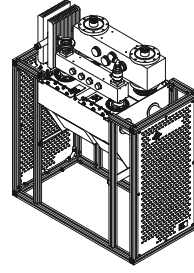

BN 576042A0010

Multi Channel Combiners

Part Number	BN 576040A0010	BN 576041A0010	BN 576042A0010
Frequency range	470 - 800 MHz		
Channel spacing	≥ 2		
Narrowband input	1 5/8" EIA		
Filter type integrated cavities/size	3/200 ≡ BN 616434		
Temperature stability	≤ 2 kHz / K		
Harmonics attenuation	≥ 25 dB for f ≤ 860 MHz		
DTV mask filtering	No		
Channel width	8 MHz ($\dot{U}/U_{rms}=13$ dB)		6 MHz ($\dot{U}/U_{rms}=13$ dB)
Average input power	≤ 7 kW		≤ 7 kW
Tuning instruction	AS3002		AS3004
Insertion loss (alternative tuning on request)	470 MHz 860 MHz f_0 ≤ 0.15 dB ≤ 0.20 dB $f_0 \pm 3.885$ ≤ 0.20 dB ≤ 0.25 dB $f_0 \pm 20$ ≥ 17 dB		470 MHz 803 MHz f_0 ≤ 0.20 dB ≤ 0.25 dB $f_0 \pm 3.0$ ≤ 0.20 dB ≤ 0.25 dB $f_0 \pm 15$ ≥ 17 dB
Group delay variation	$\Delta\tau \leq 10$ ns		$\Delta\tau \leq 10$ ns
Wideband input	1 5/8" EIA	3 1/8" EIA male	4 1/2" EIA male
Average input power	≤ 7 kW	≤ 17.5 kW	≤ 33 kW
	Attention: The power at the wideband input must be reduced by 50 % of the power fed into the narrowband input.		
DTV mask filtering	No		
Insertion loss	≤ 0.1 dB (non adjacent)		
Output	1 5/8" EIA	3 1/8" EIA male	4 1/2" EIA male
Peak output voltage	≤ 8.5 kV	≤ 12.5 kV	≤ 15.5 kV
Average output power	≤ 7 kW	–	–
Isolation between inputs	≥ 35 dB		
VSWR (one WB channel)	≤ 1.06		
Dimensions (L x W x H) mm	900 x 480 x 1200		
Weight	≈ 80 kg	≈ 90 kg	≈ 100 kg
Environmental conditions	For limitations see „Environmental Conditions for Broadcast Products“.		

CCS UHF CIB Combiners

- **CCS** compact design
- For 6, 7 and 8 MHz channel bandwidth
- Temperature compensated
- Tuneable within the whole UHF range

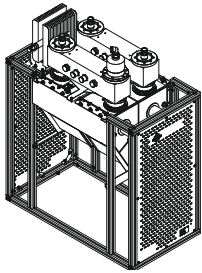
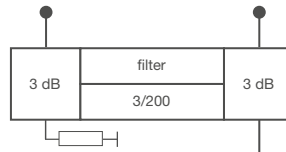

BN 576043A0010

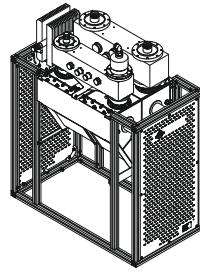

BN 576044A0010

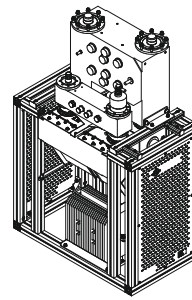

BN 576045A0020

Part Number	BN 576043A0010	BN 576044A0010	BN 576045A0020
Frequency range		470 - 800 MHz	
Channel spacing		≥ 2	
Narrowband input		3 1/8" EIA male	
Filter type integrated cavities/size		3/200 ≡ BN 616434	
Temperature stability		≤ 2 kHz / K	
Harmonics attenuation		≥ 25 dB for f ≤ 860 MHz	
DTV mask filtering		No	
Channel width	8 MHz ($\dot{U}/U_{rms}=13$ dB)		6 MHz ($\dot{U}/U_{rms}=13$ dB)
Average input power		≤ 20 kW	
Tuning instruction	AS3002		AS3004
Insertion loss (alternative tuning on request)		470 MHz 860 MHz f_0 ≤ 0.15 dB ≤ 0.20 dB $f_0 \pm 3.885$ ≤ 0.20 dB ≤ 0.25 dB $f_0 \pm 20$ ≥ 17 dB	470 MHz 803 MHz f_0 ≤ 0.20 dB ≤ 0.25 dB $f_0 \pm 3.0$ ≤ 0.20 dB ≤ 0.25 dB $f_0 \pm 15$ ≥ 17 dB
Group delay variation		$\Delta\tau \leq 10$ ns	$\Delta\tau \leq 10$ ns
Wideband input	3 1/8" EIA male	4 1/2" EIA male	52-120 BT male
Average input power	≤ 17 kW	≤ 33 kW	≤ 60 kW
	Attention: The power at the wideband input must be reduced by 50 % of the power fed into the narrowband input.		
DTV mask filtering		No	
Insertion loss		≤ 0.1 dB (non adjacent)	
Output	3 1/8" EIA male	4 1/2" EIA male	52-120 BT male
Peak output voltage	≤ 12.5 kV	≤ 15.5 kV	≤ 19.5 kV
Average output power	–	–	≤ 60 kW
Isolation between inputs		≥ 35 dB	
VSWR (one WB channel)		≤ 1.06	
Dimensions (L x W x H) mm		900 x 480 x 1200	
Weight	≈ 95 kg	≈ 115 kg	≈ 155 kg
Environmental conditions	For limitations see „Environmental Conditions for Broadcast Products“.		

CCS UHF CIB Combiners

- **CCS** compact design
- For 6, 7 and 8 MHz channel bandwidth
- Temperature compensated
- Tuneable within the whole UHF range

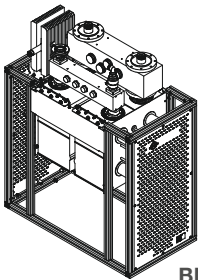
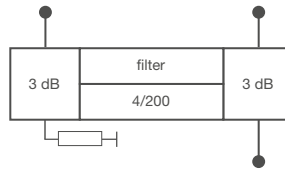

BN 576046A0010

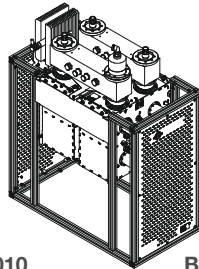

BN 576047A0010

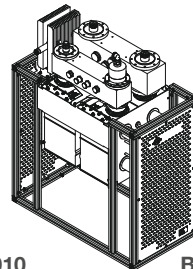

BN 576048A0010

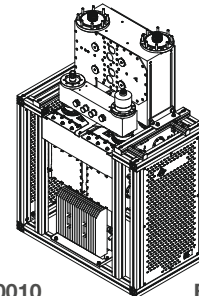

BN 576049A0020

Multi Channel Combiners

Part Number	BN 576046A0010	BN 576047A0010	BN 576048A0010	BN 576049A0020
Frequency range	470 - 800 MHz			
Channel spacing	≥ 1			
Narrowband input	1 5/8" EIA	3 1/8" EIA male		
Filter type integrated cavities/size	4/200 ≡ BN 616409			
Temperature stability	≤ 2 kHz / K			
Harmonics attenuation	≥ 40 dB for f ≤ 800 MHz			
DTV mask filtering	No			
Channel width	8 MHz ($\dot{U}/U_{rms}=13$ dB)		6 MHz ($\dot{U}/U_{rms}=13$ dB)	
Average input power	≤ 7 kW BN 576046A0010 ≤ 15 kW BN 576047A0010 ≤ 15 kW BN 576048A0010 ≤ 15 kW BN 576049A0020		≤ 7 kW BN 576046A0010 ≤ 15 kW BN 576047A0010 ≤ 15 kW BN 576048A0010 ≤ 15 kW BN 576049A0020	
Tuning instruction	AS4056		AS4057	
Insertion loss & mask filtering (alternative tuning on request)		470 MHz 860 MHz		470 MHz 803 MHz
	f_0	≤ 0.25 dB ≤ 0.3 dB	f_0	≤ 0.3 dB ≤ 0.35 dB
	$f_0 \pm 3.885$	≤ 0.25 dB ≤ 0.3 dB	$f_0 \pm 2.79$	≤ 0.3 dB ≤ 0.35 dB
	$f_0 \pm 12$	≥ 30 dB	$f_0 \pm 9$	≥ 30 dB
Group delay variation	$\Delta\tau \leq 40$ ns		$\Delta\tau \leq 40$ ns	
Wideband input	4 1/2" EIA male	3 1/8" EIA male	4 1/2" EIA male	52-120 BT male
Average input power	≤ 33 kW	≤ 17.5 kW	≤ 33 kW	≤ 60 kW
	Attention: The power at the wideband input must be reduced by 50 % of the power fed into the narrowband input.			
DTV mask filtering	No			
Insertion loss	≤ 0.1 dB (non adjacent)			
Output	4 1/2" EIA male	3 1/8" EIA male	4 1/2" EIA male	52-120 BT male
Peak output voltage	≤ 15.5 kV	≤ 12.5 kV	≤ 15.5 kV	≤ 19.5 kV
Average output power	-	-	-	≤ 60 kW
Isolation between inputs	≥ 35 dB			
VSWR (one WB channel)	≤ 1.06			
Dimensions (L x W x H) mm	900 x 480 x 1200			900 x 520 x 1400
Weight	≈ 120 kg	≈ 115 kg	≈ 125 kg	≈ 180 kg
Environmental conditions	For limitations see „Environmental Conditions for Broadcast Products“.			

CCS UHF CIB Combiners

- **CCS** compact design
- Integrated mask filters for ATSC
- For 6 MHz channel bandwidth
- Temperature compensated
- Tuneable within the whole UHF range
- Liquid cooled filter

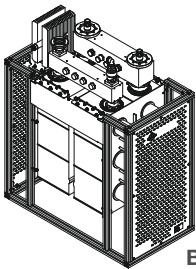
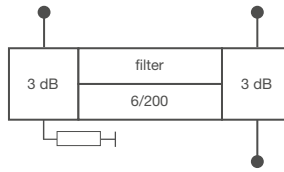

BN 576095A0010

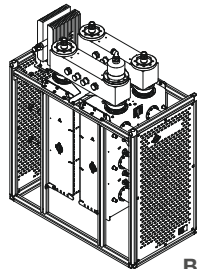

BN 576096A0010

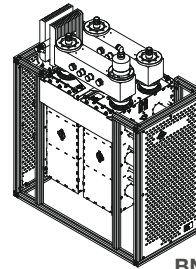

BN 576096A2010

Part Number Cooling	BN 576095A0010 Natural Cooling	BN 576096A0010 Natural Cooling	BN 576096A2010 Liquid Cooling
Frequency range		470 - 800 MHz	
Channel spacing		≥ 1	
Narrowband input	1 5/8" EIA	3 1/8" EIA male	3 1/8" EIA male
Filter type integrated cavities/size		6/200 ≡ BN 616571	
Temperature stability		≤ 2 kHz / K	
Harmonics attenuation		≥ 50 dB for f ≤ 860 MHz	
DTV mask filtering		ATSC 1.0 @ 6 MHz ($\dot{U}/U_{rms}=11$ dB)	
Average input power The input power of liquid cooled filters must be reduced if installed more than 500 m above sea level.	≤ 7 kW	≤ 9 kW	≤ 20 kW @ 0 - 600 m ≤ 18 kW @ 1200 m ≤ 16 kW @ 2000 m ≤ 14 kW @ 2800 m ≤ 12 kW @ 3400 m ≤ 10 kW @ 4000 m
Tuning instruction		AS6082	
Insertion loss & mask filtering (alternative tuning on request)		470 MHz	860 MHz
		f_0	≤ 0.5 dB ≤ 0.70 dB
		$f_0 \pm 2.69$	≤ 0.7 dB ≤ 0.90 dB
		$f_0 \pm 3$	≤ 1.5 dB ≤ 1.85 dB
		$f_0 \pm 4$	≥ 15 dB
		$f_0 \pm 6$	≥ 40 dB
		$f_0 \pm 9$	≥ 65 dB
Group delay variation		$\Delta\tau \leq 200$ ns	
Wideband input		3 1/8" EIA male	
Average input power		≤ 17.5 kW	
		Attention: The power at the wideband input must be reduced by 50 % of the power fed into the narrowband input.	
DTV mask filtering		No	
Insertion loss		≤ 0.1 dB (non adjacent)	
Output		3 1/8" EIA male	
Peak output voltage		≤ 12.5 kV	
Average output power		≤ 23.0 kW	
Isolation between inputs		≥ 35 dB	
VSWR (one WB channel)		≤ 1.06	
Dimensions (L x W x H) mm		900 x 480 x 1200	
Weight	≈ 135 kg	≈ 150 kg	≈ 150 kg
Environmental conditions	For limitations see „Environmental Conditions for Broadcast Products“.		

CCS UHF CIB Combiners

- **CCS** compact design
- Integrated mask filters for ATSC
- For 6 MHz channel bandwidth
- Temperature compensated
- Tuneable within the whole UHF range
- Liquid cooled filter

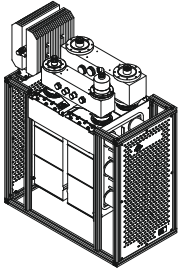
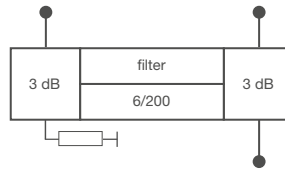

BN 576097A0010

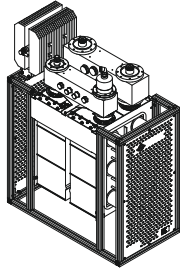

BN 576097A2010

Multi Channel Combiners

Part Number	BN 576097A0010 natural cooling	BN 576097A2010 liquid cooling																					
Frequency range	470 - 800 MHz																						
Channel spacing	≥ 1																						
Narrowband input	3 1/8" EIA																						
Filter type integrated cavities/size	6/200 ≡ BN 616571																						
Temperature stability	≤ 2 kHz / K																						
Harmonics attenuation	≥ 50 dB for f ≤ 860 MHz																						
DTV mask filtering	ATSC 1.0 @ 6 MHz ($\dot{U}/U_{rms}=11$ dB)																						
Average input power	≤ 9 kW	≤ 20 kW @ 0 - 600 m ≤ 19 kW @ 1000 m ≤ 16 kW @ 2000 m ≤ 13 kW @ 3000 m ≤ 10 kW @ 4000 m																					
Tuning instruction	AS6082																						
Insertion loss & mask filtering (alternative tuning on request)	<table border="0"> <tr> <td></td> <td>470 MHz</td> <td>803 MHz</td> </tr> <tr> <td>f_0</td> <td>≤ 0.5 dB</td> <td>≤ 0.7 dB</td> </tr> <tr> <td>$f_0 \pm 2.69$</td> <td>≤ 0.7 dB</td> <td>≤ 0.9 dB</td> </tr> <tr> <td>$f_0 \pm 3$</td> <td>≤ 1.5 dB</td> <td>≤ 1.85 dB</td> </tr> <tr> <td>$f_0 \pm 4$</td> <td>≥ 15 dB</td> <td>≥ 15 dB</td> </tr> <tr> <td>$f_0 \pm 6$</td> <td>≥ 40 dB</td> <td>≥ 40 dB</td> </tr> <tr> <td>$f_0 \pm 9$</td> <td>≥ 65 dB</td> <td>≥ 65 dB</td> </tr> </table>			470 MHz	803 MHz	f_0	≤ 0.5 dB	≤ 0.7 dB	$f_0 \pm 2.69$	≤ 0.7 dB	≤ 0.9 dB	$f_0 \pm 3$	≤ 1.5 dB	≤ 1.85 dB	$f_0 \pm 4$	≥ 15 dB	≥ 15 dB	$f_0 \pm 6$	≥ 40 dB	≥ 40 dB	$f_0 \pm 9$	≥ 65 dB	≥ 65 dB
	470 MHz	803 MHz																					
f_0	≤ 0.5 dB	≤ 0.7 dB																					
$f_0 \pm 2.69$	≤ 0.7 dB	≤ 0.9 dB																					
$f_0 \pm 3$	≤ 1.5 dB	≤ 1.85 dB																					
$f_0 \pm 4$	≥ 15 dB	≥ 15 dB																					
$f_0 \pm 6$	≥ 40 dB	≥ 40 dB																					
$f_0 \pm 9$	≥ 65 dB	≥ 65 dB																					
Group delay variation	$\Delta\tau \leq 200$ ns																						
Wideband input	4 1/2" EIA																						
Average input power	≤ 33 kW																						
	Attention: The power at the wideband input must be reduced by 50 % of the power fed into the narrowband input.																						
DTV mask filtering	No																						
Insertion loss	≤ 0.1 dB (non adjacent)																						
Output	4 1/2" EIA																						
Peak output voltage	≤ 15.5 kV																						
Average output power	≤ 40 kW																						
Isolation between inputs	≥ 35 dB																						
VSWR (one WB channel)	≤ 1.06																						
Dimensions (L x W x H) mm	900 x 480 x 1200																						
Weight	≈ 165 kg																						
Environmental conditions	For limitations see „Environmental Conditions for Broadcast Products“.																						

CCS UHF CIB Combiners

- **CCS** compact design
- Integrated mask filters for DTV
- Adjacent channel operation
- For 6, 7 and 8 MHz channel bandwidth
- Temperature compensated
- Tuneable within the whole UHF range

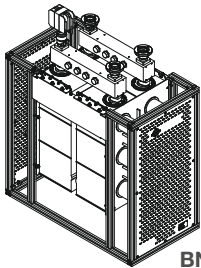
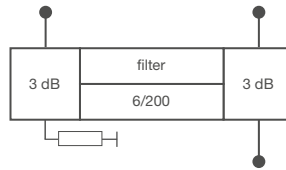

BN 576050A0010

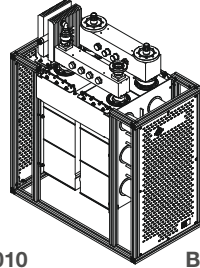

BN 576051A0010

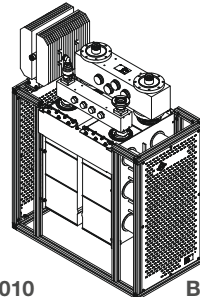

BN 576052A0010

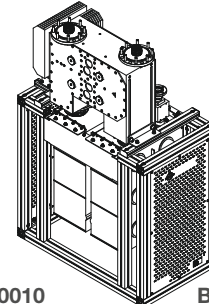

BN 576053A0020

Part Number	BN 576050A0010		BN 576051A0010		BN 576052A0010		BN 576053A0020		
Frequency range	470 - 800 MHz								
Channel spacing	≥ 0								
Narrowband input	1 5/8" EIA								
Filter type integrated cavities/size	6/200 ≡ BN 616540								
Temperature stability	≤ 2 kHz / K								
Harmonics attenuation	≥ 50 dB for f ≤ 860 MHz								
DTV mask filtering	DVB-T @ 8 MHz ($\dot{U}/U_{ms}=13$ dB)		ISDB-T @ 6 MHz ($\dot{U}/U_{ms}=13$ dB)		DVB-T @ 7 MHz ($\dot{U}/U_{ms}=13$ dB)				
Average input power	≤ 7 kW								
Tuning instruction	AS6194		AS6185		AS6290				
Insertion loss & mask filtering (alternative tuning on request)	470 MHz	860 MHz	470 MHz	803 MHz	470 MHz	820 MHz	470 MHz	820 MHz	
	f_0	≤ 0.30 dB	≤ 0.45 dB	f_0	≤ 0.4 dB	≤ 0.55 dB	f_0	≤ 0.30 dB	≤ 0.40 dB
	$f_0 \pm 3.805$	≤ 0.70 dB	≤ 1.00 dB	$f_0 \pm 2.79$	≤ 1.0 dB	≤ 1.40 dB	$f_0 \pm 3.2$	≤ 0.45 dB	≤ 0.55 dB
	$f_0 \pm 3.885$	≤ 0.85 dB	≤ 1.15 dB	$f_0 \pm 3.0$	≥ 4 dB		$f_0 \pm 4.2$	≥ 13 dB	
	$f_0 \pm 4.2$	≥ 4 dB		$f_0 \pm 3.15$	≥ 8 dB		$f_0 \pm 10.5$	≥ 38 dB	
	$f_0 \pm 6$	≥ 20 dB		$f_0 \pm 4.5$	≥ 23 dB				
	$f_0 \pm 12$	≥ 40 dB		$f_0 \pm 9$	≥ 48 dB				
			$f_0 \pm 15$	≥ 50 dB					
Group delay variation	$\Delta\tau \leq 350$ ns		$\Delta\tau \leq 500$ ns		$\Delta\tau \leq 150$ ns				
Wideband input	1 5/8" EIA		3 1/8" EIA male		4 1/2" EIA male		52-120 BT male		
Average input power	≤ 7 kW		≤ 17.5 kW		≤ 33 kW		≤ 60 kW		
	Attention: The power at the wideband input must be reduced by 50 % of the power fed into the narrowband input.								
DTV mask filtering	No								
Insertion loss	≤ 0.1 dB (non adjacent)								
Output	1 5/8" EIA		3 1/8" EIA male		4 1/2" EIA male		52-120 BT male		
Peak output voltage	≤ 8.5 kV		≤ 12.5 kV		≤ 15.5 kV		≤ 19.5 kV		
Average output power	-		-		-		≤ 60 kW		
Isolation between inputs	≥ 35 dB								
VSWR (one WB channel)	≤ 1.06								
Dimensions (L x W x H) mm	900 x 480 x 1200						900 x 520 x 1400		
Weight	≈ 130 kg		≈ 140 kg		≈ 155 kg		≈ 200 kg		
Environmental conditions	For limitations see „Environmental Conditions for Broadcast Products“.								

CCS UHF CIB Combiners

- **CCS** compact design
- Integrated mask filters for DTV
- Adjacent channel operation
- For 6, 7 and 8 MHz channel bandwidth
- Temperature compensated
- Tuneable within the whole UHF range

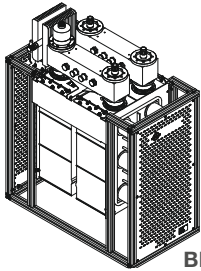

BN 576055A0010

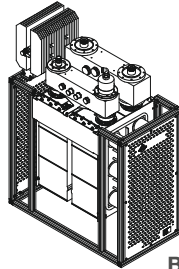

BN 576056A0010

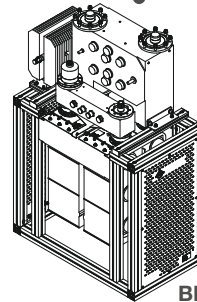
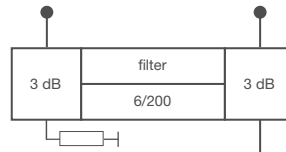

BN 576057A0020

Multi Channel Combiners

Part Number	BN 576055A0010	BN 576056A0010	BN 576057A0020
Frequency range	470 - 800 MHz		
Channel spacing	≥ 0		
Narrowband input	3 1/8" EIA male		
Filter type integrated cavities/size	6/200 ≡ BN 616540		
Temperature stability	≤ 2 kHz / K		
Harmonics attenuation	≥ 50 dB for f ≤ 860 MHz		
DTV mask filtering	DVB-T @ 8 MHz ($\dot{U}/U_{rms}=13$ dB)	ISDB-T @ 6 MHz ($\dot{U}/U_{rms}=13$ dB)	DVB-T @ 7 MHz ($\dot{U}/U_{rms}=13$ dB)
Average input power	≤ 10 kW	≤ 8 kW	≤ 9 kW
Tuning instruction	AS6194	AS6185	AS6290
Insertion loss & mask filtering (alternative tuning on request)	470 MHz 860 MHz	470 MHz 803 MHz	470 MHz 820 MHz
	f_0 ≤ 0.30 dB ≤ 0.45 dB	f_0 ≤ 0.4 dB ≤ 0.55 dB	f_0 ≤ 0.30 dB ≤ 0.40 dB
	$f_0 \pm 3.805$ ≤ 0.70 dB ≤ 1.00 dB	$f_0 \pm 2.79$ ≤ 1.0 dB ≤ 1.40 dB	$f_0 \pm 3.2$ ≤ 0.45 dB ≤ 0.55 dB
	$f_0 \pm 3.885$ ≤ 0.85 dB ≤ 1.15 dB	$f_0 \pm 3.0$ ≥ 4 dB	$f_0 \pm 4.2$ ≥ 13 dB
	$f_0 \pm 4.2$ ≥ 4 dB	$f_0 \pm 3.15$ ≥ 8 dB	$f_0 \pm 10.5$ ≥ 38 dB
	$f_0 \pm 6$ ≥ 20 dB	$f_0 \pm 4.5$ ≥ 23 dB	
	$f_0 \pm 12$ ≥ 40 dB	$f_0 \pm 9$ ≥ 48 dB	
		$f_0 \pm 15$ ≥ 50 dB	
Group delay variation	$\Delta\tau \leq 350$ ns	$\Delta\tau \leq 500$ ns	$\Delta\tau \leq 150$ ns
Wideband input	3 1/8" EIA male	4 1/2" EIA male	52-120 BT male
Average input power	≤ 17.5 kW	≤ 33 kW	≤ 60 kW
	Attention: The power at the wideband input must be reduced by 50 % of the power fed into the narrowband input.		
DTV mask filtering	No		
Insertion loss	≤ 0.1 dB (non adjacent)		
Output	3 1/8" EIA male	4 1/2" EIA male	52-120 BT male
Peak output voltage	≤ 12.5 kV	≤ 15.5 kV	≤ 19.5 kV
Average output power	-	-	≤ 60 kW
Isolation between inputs	≥ 35 dB		
VSWR (one WB channel)	≤ 1.06		
Dimensions (L x W x H) mm	900 x 480 x 1200		900 x 520 x 1400
Weight	≈ 140 kg	≈ 160 kg	≈ 205 kg
Environmental conditions	For limitations see „Environmental Conditions for Broadcast Products“.		

CCS UHF CIB Combiners

- **CCS** compact design
- For 6, 7 and 8 MHz channel bandwidth
- Tuneable within the whole UHF range
- Integrated mask filters for DTV
- Adjacent channel operation
- Temperature compensated
- Liquid cooled filters

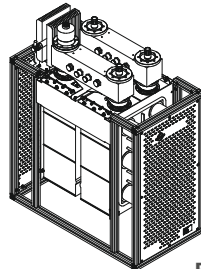
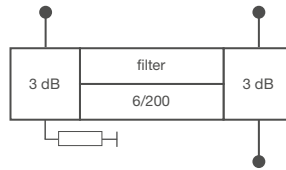

BN 576055A2010

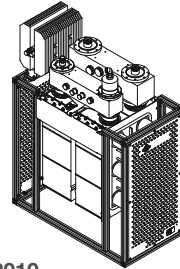

BN 576056A2020

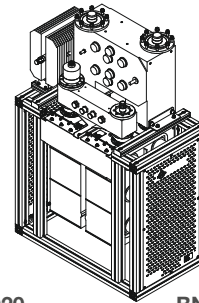

BN 576057A2020

Part Number	Liquid Cooled	BN 576055A2010	BN 576056A2010	BN 576057A2020	BN 576058A2020
Frequency range		470 - 800 MHz			
Channel spacing		≥ 0			
Narrowband input		3 1/8" EIA male			
Filter type integrated cavities/size		6/200 ≡ BN 616540			
Temperature stability		≤ 2 kHz / K			
Harmonics attenuation		≥ 50 dB for f ≤ 860 MHz			
DTV mask filtering		DVB-T @ 8 MHz (Û/U _{rms} =13 dB)	ISDB-T @ 6 MHz (Û/U _{rms} =13 dB)	DVB-T @ 7 MHz (Û/U _{rms} =13 dB)	
Average input power The input power of liquid cooled filters must be reduced if installed more than 500 m above sea level.		≤ 23 kW @ 0 - 1000 m ≤ 20 kW @ 2000 m ≤ 18 kW @ 2600 m ≤ 16 kW @ 3200 m ≤ 14 kW @ 3800 m ≤ 12 kW @ 4400 m	≤ 20 kW @ 0 - 500 m ≤ 18 kW @ 1200 m ≤ 16 kW @ 2000 m ≤ 14 kW @ 2800 m ≤ 12 kW @ 3400 m ≤ 10 kW @ 4200 m	≤ 22 kW @ 0 - 600 m ≤ 20 kW @ 1400 m ≤ 18 kW @ 2000 m ≤ 16 kW @ 2600 m ≤ 14 kW @ 3300 m ≤ 12 kW @ 4000 m	
Tuning instruction		AS6194	AS6185	AS6290	
Insertion loss & mask filtering (alternative tuning on request)		470 MHz 860 MHz	470 MHz 803 MHz	470 MHz 820 MHz	
	f ₀	≤ 0.30 dB ≤ 0.45 dB	f ₀ ≤ 0.4 dB ≤ 0.55 dB	f ₀	≤ 0.30 dB ≤ 0.40 dB
	f ₀ ± 3.805	≤ 0.70 dB ≤ 1.00 dB	f ₀ ± 2.79 ≤ 1.0 dB ≤ 1.40 dB	f ₀ ± 3.2	≤ 0.45 dB ≤ 0.55 dB
	f ₀ ± 3.885	≤ 0.85 dB ≤ 1.15 dB	f ₀ ± 3.0 ≥ 4 dB	f ₀ ± 4.2	≥ 13 dB
	f ₀ ± 4.2	≥ 4 dB	f ₀ ± 3.15 ≥ 8 dB	f ₀ ± 10.5	≥ 38 dB
	f ₀ ± 6	≥ 20 dB	f ₀ ± 4.5 ≥ 23 dB		
	f ₀ ± 12	≥ 40 dB	f ₀ ± 9 ≥ 48 dB		
			f ₀ ± 15 ≥ 50 dB		
Group delay variation		Δτ ≤ 350 ns	Δτ ≤ 500 ns	Δτ ≤ 150 ns	
Wideband input		3 1/8" EIA male	4 1/2" EIA male	52-120 BT male	6 1/8" EIA male
Average input power		≤ 17.5 kW	≤ 33 kW	≤ 60 kW	≤ 80 kW
DTV mask filtering		No			
Insertion loss		≤ 0.1 dB (non adjacent)			
Output		3 1/8" EIA male	4 1/2" EIA male	52-120 BT male	6 1/8" EIA male
Peak output voltage		≤ 12.5 kV	≤ 15.5 kV	≤ 19.5 kV	≤ 24 kV
Average output power		-	-	≤ 60 kW	
Isolation between inputs		≥ 35 dB			
VSWR (one WB channel)		≤ 1.06			
Dimensions (L x W x H) mm		900 x 480 x 1200		900 x 520 x 1400	
Weight		≈ 145 kg	≈ 165 kg	≈ 210 kg	≈ 230 kg
Liquid cooling interface		Stainless steel tube 12mm x 1 mm unflanged ending straight at the bottom			
Fan cooling interface		24 V DC mains adapter for 85 – 250 V AC / 46 – 63 Hz			
Environmental conditions		For limitations see „Environmental Conditions for Broadcast Products“.			

CCS UHF CIB Combiners

- **CCS** compact design
- Integrated mask filters for DTV
- Adjacent channel operation
- For 6, 7 and 8 MHz channel bandwidth
- Temperature compensated
- Tuneable within the whole UHF range

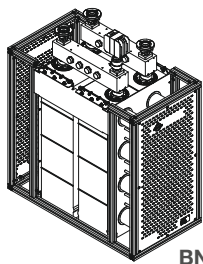
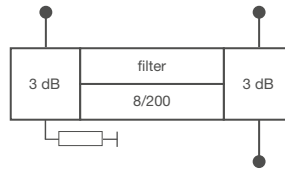

BN 576060A0010

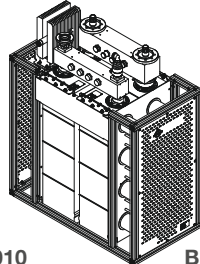

BN 576061A0010

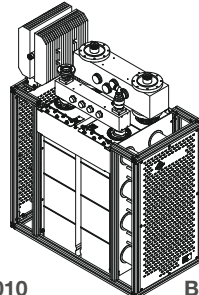

BN 576062A0010

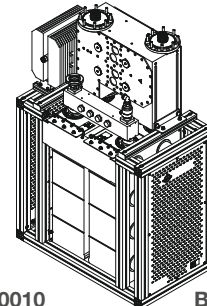

BN 576063A0020

Multi Channel
Combiners

Part Number	BN 576060A0010	BN 576061A0010	BN 576062A0010	BN 576063A0020					
Frequency range	470 - 800 MHz								
Channel spacing	≥ 0								
Narrowband input	1 5/8" EIA								
Filter type integrated cavities/size	8/200 ≡ BN 616544								
Temperature stability	≤ 2 kHz / K								
Harmonics attenuation	≥ 50 dB for f ≤ 860 MHz								
DTV mask filtering	DVB-T @ 8 MHz (Ü/U _{rms} =13 dB)	ISDB-T @ 7 MHz (Ü/U _{rms} =13 dB)	ATSC 1.0 @ 6 MHz (Ü/U _{rms} =13 dB)						
Average input power	≤ 7 kW	≤ 6.4 kW	≤ 6.4 kW						
Tuning instruction	AS8067	AS8074	AS8066						
Insertion loss & mask filtering (alternative tuning on request)	470 MHz	860 MHz	470 MHz	803 MHz	470 MHz	820 MHz			
	f ₀	≤ 0.4 dB	≤ 0.5 dB	f ₀	≤ 0.45 dB	≤ 0.5 dB	f ₀	≤ 0.5 dB	≤ 0.55 dB
	f ₀ ± 3.805	≤ 1.0 dB	≤ 1.4 dB	f ₀ ± 2.79	≤ 1.20 dB	≤ 1.5 dB	f ₀ ± 2.69	≤ 1.0 dB	≤ 1.30 dB
	f ₀ ± 3.885	≤ 1.5 dB	≤ 1.7 dB	f ₀ ± 3.15	≥ 15 dB		f ₀ ± 3.0	≥ 4 dB	
	f ₀ ± 4.2	≥ 15 dB		f ₀ ± 4.5	≥ 30 dB		f ₀ ± 3.25	≥ 18 dB	
	f ₀ ± 6	≥ 40 dB		f ₀ ± 9	≥ 55 dB		f ₀ ± 9	≥ 64 dB	
	f ₀ ± 12	≥ 55 dB							
Group delay variation	Δτ ≤ 700 ns	Δτ ≤ 500 ns		Δτ ≤ 400 ns					
Wideband input	1 5/8" EIA	3 1/8" EIA male	4 1/2" EIA male	52-120 BT male					
Average input power	≤ 7 kW	≤ 17.5 kW	≤ 33 kW	≤ 60 kW					
Attention: The power at the wideband input must be reduced by 50 % of the power fed into the narrowband input									
DTV mask filtering	No								
Insertion loss	≤ 0.1 dB (non adjacent)								
Output	1 5/8" EIA	3 1/8" EIA male	4 1/2" EIA male	52-120 BT male					
Peak output voltage	≤ 8.5 kV	≤ 12.5 kV	≤ 15.5 kV	≤ 19.5 kV					
Average output power	-	-	-	≤ 60 kW					
Isolation between inputs	≥ 35 dB								
VSWR (one WB channel)	≤ 1.06								
Dimensions (L x W x H) mm	900 x 480 x 1200			900 x 520 x 1400					
Weight	≈ 160 kg	≈ 170 kg	≈ 185 kg	≈ 230 kg					
Environmental conditions	For limitations see „Environmental Conditions for Broadcast Products“.								

CCS UHF CIB Combiners

- **CCS** compact design
- Integrated mask filters for DTV
- Adjacent channel operation
- For 6, 7 and 8 MHz channel bandwidth
- Temperature compensated
- Tuneable within the whole UHF range

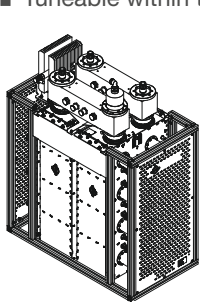

BN 576065A0010

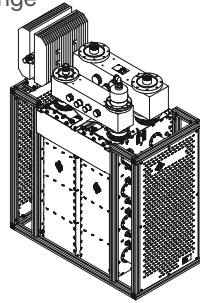

BN 576066A0010

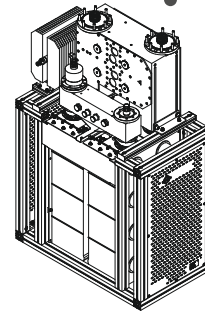
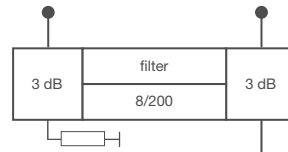

BN 576067A0020

Part Number	BN 576065A0010	BN 576066A0010	BN 576067A0020
Frequency range		470 - 800 MHz	
Channel spacing		≥ 0	
Narrowband input		3 1/8" EIA male	
Filter type integrated cavities/size		8/200 ≡ BN 616544	
Temperature stability		≤ 2 kHz / K	
Harmonics attenuation		≥ 50 dB for f ≤ 860 MHz	
DTV mask filtering	DVB-T @ 8 MHz (Ü/U _{rms} =13 dB)	ISDB-T @ 7 MHz (Ü/U _{rms} =13 dB)	ATSC 1.0 @ 6 MHz (Ü/U _{rms} =13 dB)
Average input power	≤ 8 kW	≤ 6.4 kW	≤ 6.4 kW
Tuning instruction	AS8067	AS8074	AS8066
Insertion loss & mask filtering (alternative tuning on request)	470 MHz 860 MHz f ₀ ≤ 0.4 dB ≤ 0.5 dB f ₀ ± 3.805 ≤ 1.0 dB ≤ 1.4 dB f ₀ ± 3.885 ≤ 1.5 dB ≤ 1.7 dB f ₀ ± 4.2 ≥ 15 dB f ₀ ± 6 ≥ 40 dB f ₀ ± 12 ≥ 55 dB	470 MHz 803 MHz f ₀ ≤ 0.45 dB ≤ 0.5 dB f ₀ ± 2.79 ≤ 1.20 dB ≤ 1.5 dB f ₀ ± 3.15 ≥ 15 dB f ₀ ± 4.5 ≥ 30 dB f ₀ ± 9 ≥ 55 dB	470 MHz 820 MHz f ₀ ≤ 0.5 dB ≤ 0.55 dB f ₀ ± 2.69 ≤ 1.0 dB ≤ 1.30 dB f ₀ ± 3.0 ≥ 4 dB f ₀ ± 3.25 ≥ 18 dB f ₀ ± 9 ≥ 64 dB
Group delay variation	Δτ ≤ 700 ns	Δτ ≤ 500 ns	Δτ ≤ 400 ns
Wideband input	3 1/8" EIA male	4 1/2" EIA male	52-120 BT male
Average input power	≤ 17.5 kW	≤ 33 kW	≤ 60 kW
DTV mask filtering		No	
Insertion loss		≤ 0.1 dB (non adjacent)	
Output	3 1/8" EIA male	4 1/2" EIA male	52-120 BT male
Peak output voltage	≤ 12.5 kV	≤ 15.5 kV	≤ 19.5 kV
Average output power	-	-	≤ 60 kW
Isolation between inputs		≥ 35 dB	
VSWR (one WB channel)		≤ 1.06	
Dimensions (L x W x H) mm	900 x 480 x 1200		900 x 520 x 1400
Weight	≈ 175 kg	≈ 190 kg	≈ 240 kg
Environmental conditions	For limitations see „Environmental Conditions for Broadcast Products“.		

CCS UHF CIB Combiners

- **CCS** compact design
- Integrated mask filters for DTV
- Adjacent channel operation
- For 6, 7 and 8 MHz channel bandwidth
- Temperature compensated
- Tuneable within the whole UHF range
- Liquid cooled filter

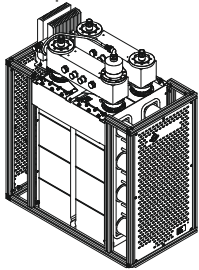

BN 576065A2010

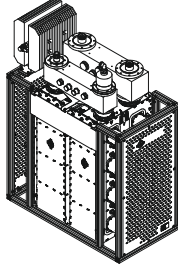

BN 576066A2010

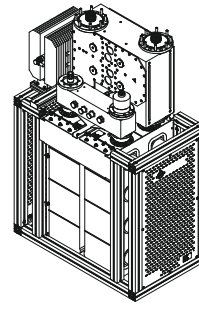
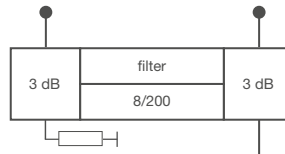

BN 576067A2020

Multi Channel Combiners

Part Number Cooling	BN 576065A2010 Liquid Cooling	BN 576066A2010 Liquid Cooling	BN 576067A2020 Liquid Cooling																																																									
Frequency range	470 - 800 MHz																																																											
Channel spacing	≥ 0																																																											
Narrowband input	3 1/8" EIA male																																																											
Filter type integrated cavities/size	8/200 ≡ BN 616544																																																											
Temperature stability	≤ 2 kHz / K																																																											
Harmonics attenuation	≥ 50 dB for f ≤ 860 MHz																																																											
DTV mask filtering	DVB-T @ 8 MHz ($\dot{U}/U_{rms}=13$ dB)	ISDB-T @ 6 MHz ($\dot{U}/U_{rms}=13$ dB)	ATSC 1.0 @ 6 MHz ($\dot{U}/U_{rms}=13$ dB)																																																									
Average input power The input power of liquid cooled filters must be reduced if installed more than 500 m above sea level.	≤ 23 kW @ 0 - 1000 m ≤ 20 kW @ 2000 m ≤ 18 kW @ 2600 m ≤ 16 kW @ 3200 m ≤ 14 kW @ 3800 m ≤ 12 kW @ 4400 m	≤ 20 kW @ 0 - 500 m ≤ 18 kW @ 1200 m ≤ 16 kW @ 2000 m ≤ 14 kW @ 2800 m ≤ 12 kW @ 3400 m ≤ 10 kW @ 4200 m	≤ 22 kW @ 0 - 600 m ≤ 20 kW @ 1400 m ≤ 18 kW @ 2000 m ≤ 16 kW @ 2600 m ≤ 14 kW @ 3300 m ≤ 12 kW @ 4000 m																																																									
Tuning instruction	AS8067	AS8074	AS8066																																																									
Insertion loss & mask filtering (alternative tuning on request)	<table border="1"> <tr> <td></td> <td>470 MHz</td> <td>860 MHz</td> </tr> <tr> <td>f_0</td> <td>≤ 0.4 dB</td> <td>≤ 0.5 dB</td> </tr> <tr> <td>$f_0 \pm 3.805$</td> <td>≤ 1.0 dB</td> <td>≤ 1.4 dB</td> </tr> <tr> <td>$f_0 \pm 3.885$</td> <td>≤ 1.5 dB</td> <td>≤ 1.7 dB</td> </tr> <tr> <td>$f_0 \pm 4.2$</td> <td>≥ 15 dB</td> <td></td> </tr> <tr> <td>$f_0 \pm 6$</td> <td>≥ 40 dB</td> <td></td> </tr> <tr> <td>$f_0 \pm 12$</td> <td>≥ 55 dB</td> <td></td> </tr> </table>		470 MHz	860 MHz	f_0	≤ 0.4 dB	≤ 0.5 dB	$f_0 \pm 3.805$	≤ 1.0 dB	≤ 1.4 dB	$f_0 \pm 3.885$	≤ 1.5 dB	≤ 1.7 dB	$f_0 \pm 4.2$	≥ 15 dB		$f_0 \pm 6$	≥ 40 dB		$f_0 \pm 12$	≥ 55 dB		<table border="1"> <tr> <td></td> <td>470 MHz</td> <td>803 MHz</td> </tr> <tr> <td>f_0</td> <td>≤ 0.45 dB</td> <td>≤ 0.5 dB</td> </tr> <tr> <td>$f_0 \pm 2.79$</td> <td>≤ 1.20 dB</td> <td>≤ 1.5 dB</td> </tr> <tr> <td>$f_0 \pm 3.15$</td> <td>≥ 15 dB</td> <td></td> </tr> <tr> <td>$f_0 \pm 4.5$</td> <td>≥ 30 dB</td> <td></td> </tr> <tr> <td>$f_0 \pm 9$</td> <td>≥ 55 dB</td> <td></td> </tr> </table>		470 MHz	803 MHz	f_0	≤ 0.45 dB	≤ 0.5 dB	$f_0 \pm 2.79$	≤ 1.20 dB	≤ 1.5 dB	$f_0 \pm 3.15$	≥ 15 dB		$f_0 \pm 4.5$	≥ 30 dB		$f_0 \pm 9$	≥ 55 dB		<table border="1"> <tr> <td></td> <td>470 MHz</td> <td>820 MHz</td> </tr> <tr> <td>f_0</td> <td>≤ 0.5 dB</td> <td>≤ 0.55 dB</td> </tr> <tr> <td>$f_0 \pm 2.69$</td> <td>≤ 1.0 dB</td> <td>≤ 1.30 dB</td> </tr> <tr> <td>$f_0 \pm 3.0$</td> <td>≥ 4 dB</td> <td></td> </tr> <tr> <td>$f_0 \pm 3.25$</td> <td>≥ 18 dB</td> <td></td> </tr> <tr> <td>$f_0 \pm 9$</td> <td>≥ 64 dB</td> <td></td> </tr> </table>		470 MHz	820 MHz	f_0	≤ 0.5 dB	≤ 0.55 dB	$f_0 \pm 2.69$	≤ 1.0 dB	≤ 1.30 dB	$f_0 \pm 3.0$	≥ 4 dB		$f_0 \pm 3.25$	≥ 18 dB		$f_0 \pm 9$	≥ 64 dB	
	470 MHz	860 MHz																																																										
f_0	≤ 0.4 dB	≤ 0.5 dB																																																										
$f_0 \pm 3.805$	≤ 1.0 dB	≤ 1.4 dB																																																										
$f_0 \pm 3.885$	≤ 1.5 dB	≤ 1.7 dB																																																										
$f_0 \pm 4.2$	≥ 15 dB																																																											
$f_0 \pm 6$	≥ 40 dB																																																											
$f_0 \pm 12$	≥ 55 dB																																																											
	470 MHz	803 MHz																																																										
f_0	≤ 0.45 dB	≤ 0.5 dB																																																										
$f_0 \pm 2.79$	≤ 1.20 dB	≤ 1.5 dB																																																										
$f_0 \pm 3.15$	≥ 15 dB																																																											
$f_0 \pm 4.5$	≥ 30 dB																																																											
$f_0 \pm 9$	≥ 55 dB																																																											
	470 MHz	820 MHz																																																										
f_0	≤ 0.5 dB	≤ 0.55 dB																																																										
$f_0 \pm 2.69$	≤ 1.0 dB	≤ 1.30 dB																																																										
$f_0 \pm 3.0$	≥ 4 dB																																																											
$f_0 \pm 3.25$	≥ 18 dB																																																											
$f_0 \pm 9$	≥ 64 dB																																																											
Group delay variation	$\Delta\tau \leq 700$ ns	$\Delta\tau \leq 500$ ns	$\Delta\tau \leq 400$ ns																																																									
Wideband input	3 1/8" EIA male	4 1/2" EIA male	52-120 BT male																																																									
Average input power	≤ 17.5 kW	≤ 33 kW	≤ 60 kW																																																									
DTV mask filtering	No																																																											
Insertion loss	≤ 0.1 dB (non adjacent)																																																											
Output	3 1/8" EIA male	4 1/2" EIA male	52-120 BT male																																																									
Peak output voltage	≤ 12.5 kV	≤ 15.5 kV	≤ 19.5 kV																																																									
Average output power	-	-	≤ 60 kW																																																									
Isolation between inputs	≥ 35 dB																																																											
VSWR (one WB channel)	≤ 1.06																																																											
Dimensions (L x W x H) mm	900 x 480 x 1200		900 x 520 x 1400																																																									
Weight	≈ 170 kg	≈ 180 kg	≈ 235 kg																																																									
Environmental conditions	For limitations see „Environmental Conditions for Broadcast Products“.																																																											

CCS UHF CIB Combiners

- **CCS** compact design
- Integrated mask filters for DTV
- Adjacent channel operation
- For 6, 7 and 8 MHz channel bandwidth
- Temperature compensated
- Tuneable within the whole UHF range

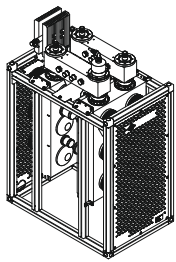
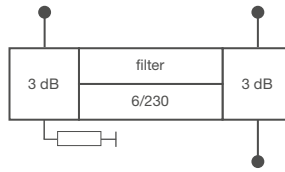

BN 576070A0080

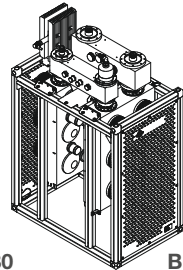

BN 576071A0080

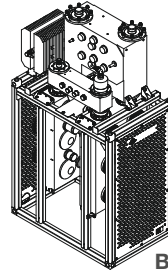

BN 576072A0080

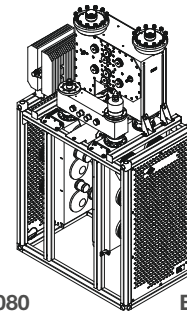

BN 576073A0080

Part Number	BN 576070A0080	BN 576071A0080	BN 576072A0080	BN 576073A0080			
Frequency range	470 - 800 MHz						
Channel spacing	≥ 0						
Narrowband input	3 1/8" EIA male						
Filter type integrated cavities/size	6/230 ≡ BN 616669						
Temperature stability	≤ 2 kHz / K						
Harmonics attenuation	≥ 50 dB for f ≤ 800 MHz						
DTV mask filtering	DVB-T @ 8 MHz ($\dot{U}/U_{rms}=13$ dB)	ISDB-T @ 6 MHz ($\dot{U}/U_{rms}=13$ dB)	ATSC 1.0 @ 6 MHz ($\dot{U}/U_{rms}=11$ dB)				
Average input power	≤ 17 kW	≤ 13.5 kW	≤ 13.5 kW				
Tuning instruction	AS6303	AS6365	AS6308				
Insertion loss & mask filtering (alternative tuning on request)	470 MHz	786 MHz	470 MHz	785 MHz			
	f_0	≤ 0.30 dB	≤ 0.4 dB	f_0	≤ 0.45 dB	≤ 0.5 dB	
	$f_0 \pm 3.805$	≤ 0.75 dB	≤ 0.9 dB	$f_0 \pm 2.79$	≤ 0.85 dB	≤ 1.0 dB	
	$f_0 \pm 3.885$	≤ 0.85 dB	≤ 1.0 dB	$f_0 \pm 3.0$	≥ 2 dB	$f_0 \pm 3.5$	≥ 3 dB
	$f_0 \pm 4.2$	≥ 4 dB		$f_0 \pm 3.15$	≥ 8 dB	$f_0 \pm 4$	≥ 8 dB
	$f_0 \pm 6$	≥ 20 dB		$f_0 \pm 4.5$	≥ 23 dB	$f_0 \pm 6$	≥ 30 dB
	$f_0 \pm 12$	≥ 40 dB		$f_0 \pm 9$	≥ 48 dB	$f_0 \pm 9$	≥ 65 dB
	$f_0 \pm 15$	≥ 50 dB					
Group delay variation	$\Delta\tau \leq 350$ ns		$\Delta\tau \leq 500$ ns				
Wideband input	3 1/8" EIA male	4 1/2" EIA male	52-120 BT male	6 1/8" EIA male			
Average input power	≤ 17.5 kW	≤ 33 kW	≤ 60 kW	≤ 60 kW			
	Attention: The power at the wideband input must be reduced by 50 % of the power fed into the narrowband input.						
DTV mask filtering	No						
Insertion loss	≤ 0.1 dB (non adjacent)						
Output	3 1/8" EIA male	4 1/2" EIA male	52-120 BT male	6 1/8" EIA male			
Peak output voltage	≤ 12.5 kV	≤ 15.5 kV	≤ 19.5 kV	≤ 24 kV			
Average output power	-	-	≤ 60 kW	-			
Isolation between inputs	≥ 35 dB						
VSWR (one WB channel)	≤ 1.06						
Dimensions (L x W x H) mm	900 x 570 x 1400		900 x 570 x 1600	900 x 570 x 1650			
Weight	≈ 160 kg	≈ 170 kg	≈ 220 kg	≈ 245 kg			
Environmental conditions	For limitations see „Environmental Conditions for Broadcast Products“.						

CCS UHF CIB Combiners

- **CCS** compact design
- Integrated mask filters for DTV
- Adjacent channel operation
- For 6, 7 and 8 MHz channel bandwidth
- Temperature compensated
- Tuneable within the whole UHF range
- Liquid cooled filters and couplers

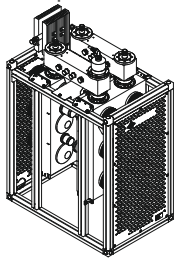
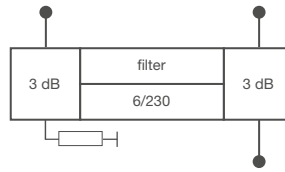

BN 576070A2080

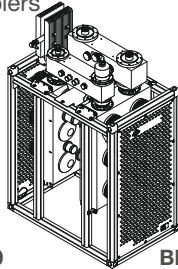

BN 576071A2080

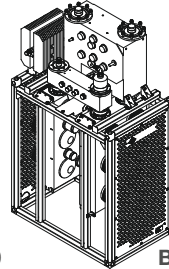

BN 576072A2080

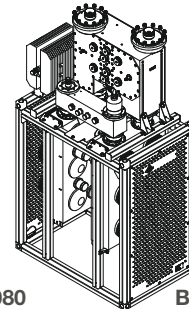

BN 576073A2080

Multi Channel Combiners

Part Number Cooling	BN 576070A2080 Liquid Cooling	BN 576071A2080 Liquid Cooling	BN 576072A2080 Liquid Cooling	BN 576073A2080 Liquid Cooling
Frequency range	470 - 800 MHz			
Channel spacing	≥ 0			
Narrowband input	3 1/8" EIA male			
Filter type integrated cavities/size	6/230 ≡ BN 616669			
Temperature stability	≤ 2 kHz / K			
Harmonics attenuation	≥ 50 dB for f ≤ 800 MHz			
DTV mask filtering	DVB-T @ 8 MHz ($\dot{U}/U_{rms}=13$ dB)	ISDB-T @ 6 MHz ($\dot{U}/U_{rms}=13$ dB)		ATSC 1.0 @ 6 MHz ($\dot{U}/U_{rms}=11$ dB)
Average input power The input power of liquid cooled filters must be reduced if installed more than 500 m above sea level.	≤ 23 kW @ 0 - 3200 m ≤ 20 kW @ 3800 m ≤ 18 kW @ 4200 m	≤ 23 kW @ 0 - 2200 m ≤ 20 kW @ 3000 m ≤ 18 kW @ 3400 m ≤ 16 kW @ 4000 m		≤ 23 kW @ 0 - 3200 m ≤ 20 kW @ 3800 m ≤ 18 kW @ 4200 m
Tuning instruction	AS6303		AS6365	
Insertion loss & mask filtering (alternative tuning on request)	AS6303		AS6365	
	470 MHz	786 MHz	470 MHz	785 MHz
f_0	≤ 0.30 dB	≤ 0.4 dB	≤ 0.4 dB	≤ 0.45 dB
$f_0 \pm 3.805$	≤ 0.75 dB	≤ 0.9 dB	≤ 0.85 dB	≤ 1.00 dB
$f_0 \pm 3.885$	≤ 0.85 dB	≤ 1.0 dB	≥ 2 dB	≥ 3 dB
$f_0 \pm 4.2$	≥ 4 dB		≥ 8 dB	≥ 8 dB
$f_0 \pm 6$	≥ 20 dB		≥ 23 dB	≥ 30 dB
$f_0 \pm 12$	≥ 40 dB		≥ 48 dB	≥ 65 dB
Group delay variation	$\Delta\tau \leq 350$ ns		$\Delta\tau \leq 500$ ns	
Wideband input	3 1/8" EIA male	4 1/2" EIA male	52-120 BT male	6 1/8" EIA male
Average input power	≤ 17.5 kW	≤ 33 kW	≤ 60 kW	≤ 80 kW
DTV mask filtering	No			
Insertion loss	≤ 0.1 dB (non adjacent)			
Output	3 1/8" EIA male	4 1/2" EIA male	52-120 BT male	6 1/8" EIA male
Peak output voltage	≤ 12.5 kV	≤ 15.5 kV	≤ 19.5 kV	≤ 24 kV
Average output power	-	-	≤ 60 kW	≤ 78 kW
Isolation between inputs	≥ 35 dB			
VSWR (one WB channel)	≤ 1.06			
Dimensions (L x W x H) mm	900 x 570 x 1400		900 x 570 x 1600	900 x 570 x 1650
Weight	≈ 160 kg	≈ 170 kg	≈ 220 kg	≈ 245 kg
Environmental conditions	For limitations see „Environmental Conditions for Broadcast Products“.			

CCS UHF CIB Combiners

- **CCS** compact design
- Integrated mask filters for DTV
- Adjacent channels operation
- For 6, 7 and 8 MHz channel bandwidth
- Temperature compensated
- Tuneable within the whole UHF range
- Liquid cooled filters

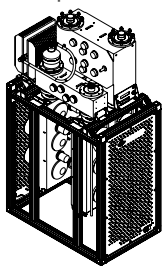
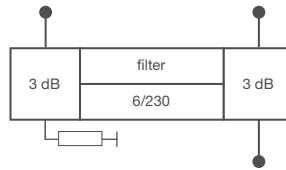

BN 576076A2080

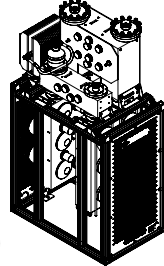

BN 576077A2080

Part Number Cooling	BN 576075A2080 Liquid Cooling	BN 576076A2080 Liquid Cooling	BN 576077A2080 Liquid Cooling	BN 576078A2080 Liquid Cooling
Frequency range	470 - 790 MHz			
Channel spacing	≥ 0			
Narrowband input	4 1/2" EIA male			
Filter type integrated cavities/size	6/230 ≡ BN 616669			
Temperature stability	≤ 2 kHz / K			
Harmonics attenuation	≥ 50 dB for f ≤ 800 MHz			
DTV mask filtering	DVB-T @ 8 MHz ($\dot{U}/U_{rms}=13$ dB)	ISDB-T @ 6 MHz ($\dot{U}/U_{rms}=13$ dB)	ATSC 1.0 @ 6 MHz ($\dot{U}/U_{rms}=11$ dB) 470 - 650 MHz	
Average input power The input power of liquid cooled filters must be reduced if installed more than 500 m above sea level.	≤ 36 kW @ 0 - 500 m ≤ 32 kW @ 1400 m ≤ 28 kW @ 2200 m ≤ 24 kW @ 3000 m ≤ 20 kW @ 3800 m	≤ 30 kW @ 0 - 500 m ≤ 28 kW @ 1000 m ≤ 24 kW @ 2000 m ≤ 20 kW @ 3000 m ≤ 16 kW @ 4000 m	≤ 40 kW @ 0 - 500 m ¹ ≤ 36 kW @ 1200 m ¹ ≤ 32 kW @ 2000 m ¹ ≤ 28 kW @ 2600 m ¹ ≤ 24 kW @ 3300 m ¹ ≤ 20 kW @ 4000 m ¹ AS6308	
Tuning instruction	AS6303		AS6365	
Insertion loss & mask filtering (alternative tuning on request)	470 MHz 790 MHz	470 MHz 790 MHz	470 MHz 790 MHz	470 MHz 650 MHz
f_0	≤ 0.30 dB ≤ 0.40 dB	f_0 ≤ 0.40 dB ≤ 0.45 dB	f_0 ≤ 0.45 dB ≤ 0.50 dB	f_0 ≤ 0.45 dB ≤ 0.50 dB
$f_0 \pm 3.805$	≤ 0.75 dB ≤ 0.90 dB	$f_0 \pm 2.79$ ≤ 0.85 dB ≤ 1.00 dB	$f_0 \pm 2.69$ ≤ 0.80 dB ≤ 0.80 dB	$f_0 \pm 2.69$ ≤ 0.80 dB ≤ 0.80 dB
$f_0 \pm 3.885$	≤ 0.85 dB ≤ 1.00 dB	$f_0 \pm 3.0$ ≥ 2 dB	$f_0 \pm 3.5$ ≥ 3 dB	$f_0 \pm 3.5$ ≥ 3 dB
$f_0 \pm 4.2$	≥ 4 dB	$f_0 \pm 3.15$ ≥ 8 dB	$f_0 \pm 4$ ≥ 8 dB	$f_0 \pm 4$ ≥ 8 dB
$f_0 \pm 6$	≥ 20 dB	$f_0 \pm 4.5$ ≥ 23 dB	$f_0 \pm 6$ ≥ 30 dB	$f_0 \pm 6$ ≥ 30 dB
$f_0 \pm 12$	≥ 40 dB	$f_0 \pm 9$ ≥ 48 dB	$f_0 \pm 9$ ≥ 65 dB	$f_0 \pm 9$ ≥ 65 dB
	$f_0 \pm 15$ ≥ 50 dB			
Group delay variation	$\Delta\tau \leq 350$ ns		$\Delta\tau \leq 500$ ns	
Wideband input	4 1/2" EIA male	52-120 BT male	6 1/8" EIA male	6 1/8" EIA male
Average input power	≤ 33 kW	≤ 60 kW	≤ 60 kW	≤ 80 kW
DTV mask filtering	No			
Insertion loss	≤ 0.1 dB (non adjacent)			
Output	4 1/2" EIA male	52-120 BT male	6 1/8" EIA male	6 1/8" EIA male
Peak output voltage	≤ 15.5 kV	≤ 19.5 kV	≤ 24 kV	≤ 24 kV
Average output power	-	≤ 60 kW	≤ 78 kW	≤ 78 kW
Isolation between inputs	≥ 35 dB			
VSWR (one WB channel)	≤ 1.06			
Dimensions (L x W x H) mm	900 x 570 x 1400		900 x 570 x 1600	
Weight	≈ 190 kg	≈ 240 kg	≈ 250 kg	≈ 260 kg
Liquid cooling interface	Stainless steel tube 12 x 1 mm unflanged ending straight at the bottom			
Environmental conditions	For limitations see „Environmental Conditions for Broadcast Products“.			

¹ P/Pmax > 90 %: Temperature stability ≤ 3 kHz / K

CCS UHF CIB Combiners

- **CCS** compact design
- Integrated mask filters for DTV
- Adjacent channel operation
- Temperature compensated
- For 6, 7 and 8 MHz channel bandwidth
- Tuneable within the whole UHF range

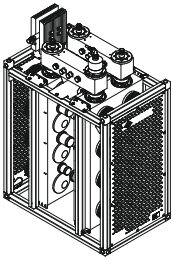
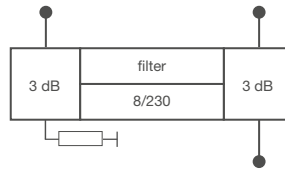

BN 576080A0080

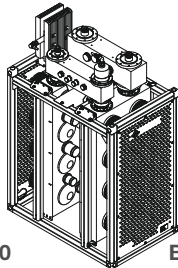

BN 576081A0080

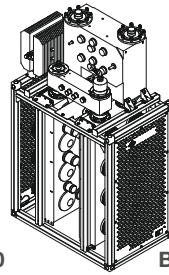

BN 576082A0080

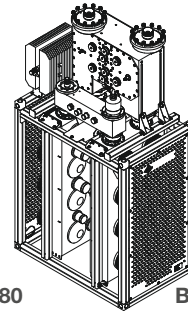

BN 576083A0080

Multi Channel
Combiners

Part Number	BN 576080A0080	BN 576081A0080	BN 576082A0080	BN 576083A0080
Frequency range	470 - 800 MHz			
Channel spacing	≥ 0			
Narrowband input	3 1/8" EIA male			
Filter type integrated cavities/size	8/230 ≡ BN 616670			
Temperature stability	≤ 2 kHz / K			
Harmonics attenuation	≥ 50 dB for f ≤ 860 MHz			
DTV mask filtering	DVB-T @ 8 MHz (Ü/U _{rms} =13 dB)	ISDB-T @ 6 MHz (Ü/U _{rms} =13 dB)	ATSC 1.0 @ 6 MHz (Ü/U _{rms} =11 dB)	
Average input power	≤ 17 kW	≤ 13.5 kW	≤ 13.5 kW	
Tuning instruction	AS8124	AS8128	AS8127	
Insertion loss & mask filtering (alternative tuning on request)	470 MHz 790 MHz f ₀ ≤ 0.4 dB ≤ 0.45 dB f ₀ ± 3.805 ≤ 1.05 dB ≤ 1.10 dB f ₀ ± 3.885 ≤ 1.25 dB ≤ 1.35 dB f ₀ ± 4.2 ≥ 15 dB f ₀ ± 6 ≥ 40 dB f ₀ ± 12 ≥ 55 dB	470 MHz 790 MHz f ₀ ≤ 0.45 dB ≤ 0.50 dB f ₀ ± 2.79 ≤ 1.15 dB ≤ 1.20 dB f ₀ ± 3.15 ≥ 15 dB f ₀ ± 4.5 ≥ 30 dB f ₀ ± 9 ≥ 55 dB f ₀ ± 15 ≥ 65 dB	470 MHz 790 MHz f ₀ ≤ 0.45 dB ≤ 0.50 dB f ₀ ± 2.69 ≤ 1.00 dB ≤ 1.10 dB f ₀ ± 3 ≥ 4 dB f ₀ ± 3.25 ≥ 18 dB f ₀ ± 9 ≥ 64 dB	470 MHz 790 MHz f ₀ ≤ 0.45 dB ≤ 0.50 dB f ₀ ± 2.69 ≤ 1.00 dB ≤ 1.10 dB f ₀ ± 3 ≥ 4 dB f ₀ ± 3.25 ≥ 18 dB f ₀ ± 9 ≥ 64 dB
Group delay variation	Δτ ≤ 700 ns	Δτ ≤ 550 ns	Δτ ≤ 450 ns	
Wideband input	3 1/8" EIA male	4 1/2" EIA male	52-120 BT male	6 1/8" EIA male
Average input power	≤ 17.5 kW	≤ 33 kW	≤ 60 kW	≤ 60 kW
DTV mask filtering	No			
Insertion loss	≤ 0.1 dB (non adjacent)			
Output	3 1/8" EIA male	4 1/2" EIA male	52-120 BT male	6 1/8" EIA male
Peak output voltage	≤ 12.5 kV	≤ 15.5 kV	≤ 19.5 kV	≤ 24 kV
Average output power	-	-	≤ 60 kW	-
Isolation between inputs	≥ 35 dB			
VSWR (one WB channel)	≤ 1.06			
Dimensions (L x W x H) mm	900 x 570 x 1400		900 x 570 x 1600	900 x 570 x 1650
Weight	≈ 200 kg	≈ 210 kg	≈ 260 kg	≈ 285 kg
Environmental conditions	For limitations see „Environmental Conditions for Broadcast Products“.			

CCS UHF CIB Combiners

- **CCS** compact design
- Integrated mask filters for DTV
- Adjacent channel operation
- Temperature compensated
- For 6, 7 and 8 MHz channel bandwidth
- Tuneable within the whole UHF range
- Liquid cooled filters and couplers

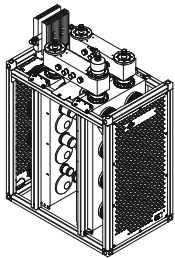
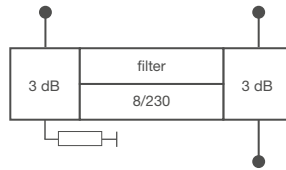

BN 576080A2080

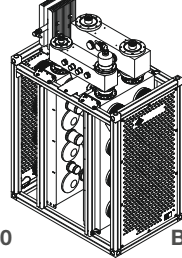

BN 576081A2080

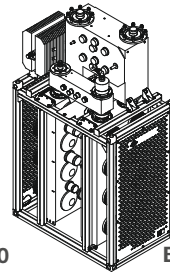

BN 576082A2080

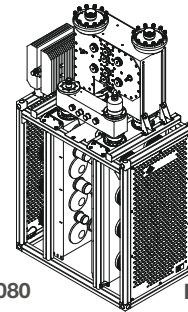

BN 576083A2080

Part Number Cooling	BN 576080A2080 Liquid Cooling	BN 576081A2080 Liquid Cooling	BN 576082A2080 Liquid Cooling	BN 576083A2080 Liquid Cooling
Frequency range	470 - 800 MHz			
Channel spacing	≥ 0			
Narrowband input	3 1/8" EIA male			
Filter type integrated cavities/size	8/230 ≡ BN 616670			
Temperature stability	≤ 2 kHz / K			
Harmonics attenuation	≥ 50 dB for f ≤ 860 MHz			
DTV mask filtering	DVB-T @ 8 MHz (Û/U _{rms} =13 dB)	ISDB-T @ 6 MHz (Û/U _{rms} =13 dB)		ATSC 1.0 @ 6 MHz (Û/U _{rms} =11 dB)
Average input power The input power of liquid cooled filters must be reduced if installed more than 500 m above sea level.	≤ 23 kW @ 0 -2700 m ≤ 22 kW @ 3000 m ≤ 20 kW @ 3400 m ≤ 18 kW @ 3800 m ≤ 16 kW @ 4200 m	≤ 23 kW @ 0 - 1600 m ≤ 22 kW @ 1800 m ≤ 20 kW @ 2400 m ≤ 18 kW @ 3000 m ≤ 16 kW @ 3400 m ≤ 14 kW @ 4000 m		≤ 23 kW @ 0 - 1600 m ≤ 22 kW @ 1800 m ≤ 20 kW @ 2400 m ≤ 18 kW @ 3000 m ≤ 16 kW @ 3400 m ≤ 14 kW @ 4000 m
Tuning instruction	AS8124		AS8128	
Insertion loss & mask filtering (alternative tuning on request)	470 MHz 790 MHz	470 MHz 790 MHz	470 MHz 790 MHz	470 MHz 790 MHz
	f ₀ ≤ 0.4 dB ≤ 0.45 dB	f ₀ ≤ 0.45 dB ≤ 0.5 dB	f ₀ ≤ 0.45 dB ≤ 0.5 dB	f ₀ ≤ 0.45 dB ≤ 0.5 dB
	f ₀ ± 3.805 ≤ 1.05 dB ≤ 1.10 dB	f ₀ ± 2.79 ≤ 1.15 dB ≤ 1.20 dB	f ₀ ± 2.69 ≤ 1.00 dB ≤ 1.1 dB	f ₀ ± 2.69 ≤ 1.00 dB ≤ 1.1 dB
	f ₀ ± 3.885 ≤ 1.25 dB ≤ 1.35 dB	f ₀ ± 3.15 ≥ 15 dB	f ₀ ± 3.0 ≥ 4 dB	f ₀ ± 3.0 ≥ 4 dB
	f ₀ ± 4.2 ≥ 15 dB	f ₀ ± 4.5 ≥ 30 dB	f ₀ ± 3.25 ≥ 18 dB	f ₀ ± 3.25 ≥ 18 dB
	f ₀ ± 6 ≥ 40 dB	f ₀ ± 9 ≥ 55 dB	f ₀ ± 9 ≥ 64 dB	f ₀ ± 9 ≥ 64 dB
	f ₀ ± 12 ≥ 55 dB	f ₀ ± 15 ≥ 65 dB		
Group delay variation	Δτ ≤ 700 ns		Δτ ≤ 550 ns	
Wideband input	3 1/8" EIA male	4 1/2" EIA male	52-120 BT male	6 1/8" EIA male
Average input power	≤ 17.5 kW	≤ 33 kW	≤ 60 kW	≤ 80 kW
DTV mask filtering	No			
Insertion loss	≤ 0.1 dB (non adjacent)			
Output	3 1/8" EIA male	4 1/2" EIA male	52-120 BT male	6 1/8" EIA male
Peak output voltage	≤ 12.5 kV	≤ 15.5 kV	≤ 19.5 kV	≤ 24 kV
Average output power	-	-	≤ 60 kW	≤ 78 kW
Isolation between inputs	≥ 35 dB			
VSWR (one WB channel)	≤ 1.06			
Dimensions (L x W x H) mm	900 x 570 x 1400		900 x 570 x 1600	900 x 570 x 1650
Weight	≈ 200 kg	≈ 210 kg	≈ 260 kg	≈ 285 kg
Environmental conditions	For limitations see „Environmental Conditions for Broadcast Products“.			

Bandpass Filters



Bandpass and low-pass filters are inserted between a broadcast transmitter's output and the antenna to suppress spurious emissions. For "combined" analog transmitters, filters are needed to suppress harmonics in the vision and sound carrier signals.

For DTV transmitters, filters are used to limit out-of-channel emissions based on various mask specifications (ATSC, DAB, DVB-T and ISDB-T):

- 8 MHz DVB-T and DVB-T2 extended carrier mode
- 8 MHz analog TV
- 7 MHz DVB-T and DVB-T2
- 7 MHz analog TV
- 6 MHz DVB-T, DVB-T2, ISDB-T, ATSC 1.0 and ATSC 3.0
- 6 MHz analog TV
- 1.54 MHz DAB, DAB+ and T-DMB

Bandpass Filters

SPINNER supplies coaxial filters, dual-mode wave guide filters, dielectric filters and low-pass filters for the band 3, UHF and band L frequency ranges.

This catalog contains filter data for the most common applications. However, alternative filter tunings can also be provided for other mask requirements, applications and bandwidths. Please don't hesitate to ask us.

The filter tuning (passband and stopband insertion loss, matching and variation of group delay time) is defined by a tuning specification (e.g. AS6148). You must specify the applicable tuning specification and frequency in every order submitted to ensure that the filter will be correctly tuned in the factory.

All bandpass filters can also be integrated in multi-channel combiners, where they simultaneously isolate the transmitters and can provide mask filtering (please see the section on multi-channel combiners).

The "Environmental Conditions for Broadcast Products" listed in the annex must be complied with during operation, transportation and storage. The maximum rating of the filter depends on environmental conditions like temperature, cooling and elevation above sea level.

Most filters can be operated at up to 2300 meters above sea level at the power specified in the data sheet. For stations located at higher altitudes, the power must be reduced as indicated in the "Environmental Conditions for Broadcast Products".

For some filters with liquid cooling, derating must be performed at altitudes exceeding 500 m asl as shown in the data sheets. The input and output ports of all bandpass filters terminate inside the resonators with an open or a short and therefore block DC and low frequencies. Most bandpass filters are equipped with cross couplings to achieve steeper slopes for mask filtering. Inside multichannel combiners, cross couplings are used to permit the use of adjacent channels.

300 W - 600 W Band 3 DAB/T-DMB Bandpass Filters

- Mask filters for DAB and T-DMB
- For 1.54 MHz block bandwidth
- With cross coupling (notch function)
- Tuneable within band 3
- Temperature compensated
- DC block
- Installation horizontally or vertically



BN 617129C1025



BN 617116C1025

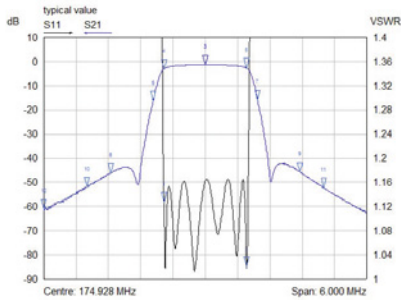

Typical diagram AS6547

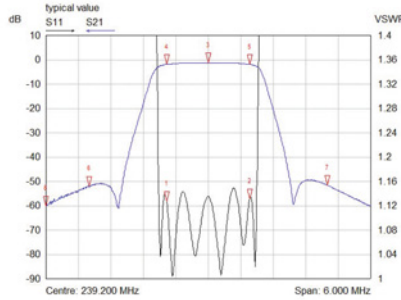

Typical diagram AS6575

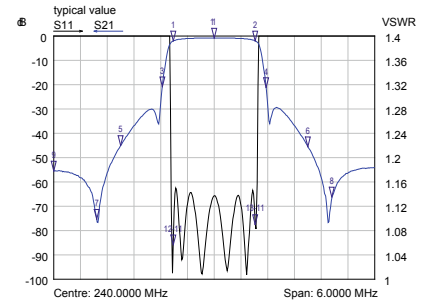

Typical diagram AS6033

Bandpass Filters

Part Number	BN 617129C1025		BN 617116C1025
Frequency range	174 - 240 MHz		
Number/size of cavities	6/70		6/100
Harmonics attenuation	≥ 50 dB for $f \leq 500$ MHz		
Mask filtering	DAB / T-DMB @ 1.54 MHz ($\dot{U}/U_{rms} = 13$ dB)		
Average input power	≤ 300 W		≤ 600 W
Tuning instruction	AS6547	AS6575	AS6033
Insertion loss & mask filtering (alternative tuning on request)	$f_0 \leq 1.4$ dB $f_0 \pm 0.77 \leq 3.5$ dB $f_0 \pm 0.97 \geq 15$ dB $f_0 \pm 1.75 \geq 45$ dB $f_0 \pm 2.20 \geq 50$ dB $f_0 \pm 3.00 \geq 50$ dB	$f_0 \leq 1.3$ dB $f_0 \pm 0.77 \leq 2.0$ dB $f_0 \pm 0.97$ $f_0 \pm 1.75$ $f_0 \pm 2.20$ $f_0 \pm 3.00 \geq 50$ dB	$f_0 \leq 0.9$ dB $f_0 \pm 0.77 \leq 2.2$ dB $f_0 \pm 0.97 \geq 15$ dB $f_0 \pm 1.75 \geq 45$ dB $f_0 \pm 2.20 \geq 53$ dB $f_0 \pm 3.00 \geq 53$ dB
VSWR (passband range)	≤ 1.17		≤ 1.15
Group delay variation	$\Delta\tau \leq 1200$ ns		
Temperature stability	≤ 1 kHz / K		
Connectors	7-16 female		
Dimensions (L x W x H) mm	410 x 448 x 89		416 x 214 x 442
Weight	≈ 19 kg		≈ 25 kg
Environmental conditions	For limitations see „Environmental Conditions for Broadcast Products“.		

1.5 kW - 1.6 kW Band 3 DAB/T-DMB Bandpass Filters

- Mask filters for DAB and T-DMB
- For 1.54 MHz block bandwidth
- Tuneable within band 3
- Temperature compensated
- DC block
- Installation standing

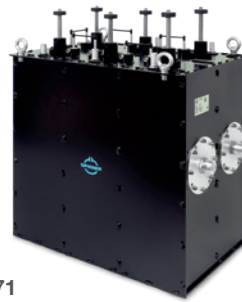

BN 617171



BN 617144

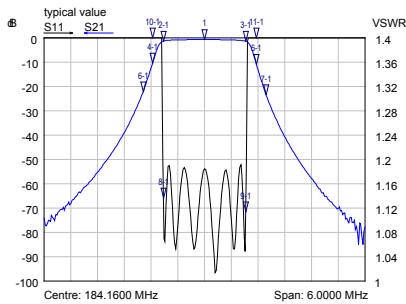

Typical diagram AS6010

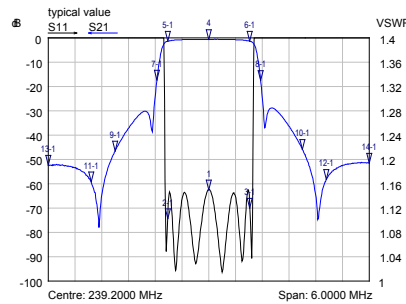

Typical diagram AS6137

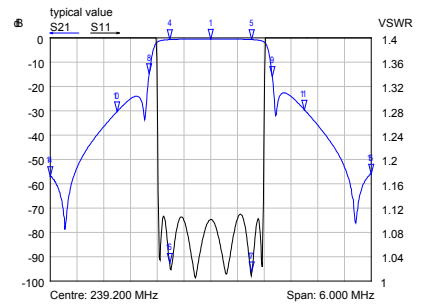

Typical diagram AS6149

Part Number Filter Design	BN 617171 Without Cross Coupling	BN 617144 With Cross Coupling	BN 617145 With Cross Coupling
Frequency range	170 - 240 MHz		215 - 240 MHz
Number/size of cavities	6/150		
Harmonics attenuation	≥ 50 dB for f ≤ 500 MHz		
Mask filtering	DAB / T-DMB @ 1.54 MHz ($\dot{U}/U_{ms} = 13$ dB)		
Average input power	≤ 1.5 kW	≤ 1.6 kW	≤ 1.6 kW
Tuning instruction	AS6010	AS6137	AS 6149
Insertion loss & mask filtering (alternative tuning on request)	$f_0 \leq 0.9$ dB $f_0 \pm 0.77 \leq 1.5$ dB $f_0 \pm 0.97 \geq 8.0$ dB $f_0 \pm 1.75 \geq 43.0$ dB $f_0 \pm 2.20 \geq 53.0$ dB $f_0 \pm 3.00 \geq 73.0$ dB	$f_0 \leq 0.65$ dB $f_0 \pm 0.77 \leq 1.50$ dB $f_0 \pm 0.97 \geq 15.0$ dB $f_0 \pm 1.75 \geq 45.0$ dB $f_0 \pm 2.20 \geq 58.0$ dB $f_0 \pm 3.00 \geq 50.0$ dB	$f_0 \leq 0.55$ dB $f_0 \pm 0.77 \leq 0.80$ dB $f_0 \pm 0.97$ n.d. $f_0 \pm 1.75 \geq 15.0$ dB $f_0 \pm 2.20 \geq 40.0$ dB $f_0 \pm 3.00 \geq 50.0$ dB
VSWR (passband range)	≤ 1.22	≤ 1.15	≤ 1.15
Group delay variation	$\Delta\tau \leq 700$ ns	$\Delta\tau \leq 1000$ ns	$\Delta\tau \leq 400$ ns
Temperature stability	≤ 1 kHz / K		
Connectors	7-16 female		
Dimensions (L x W x H) mm	465 x 326 x 680	461 x 326 x 680	495 x 325 x 476
Weight	≈ 40 kg		
Environmental conditions	For limitations see „Environmental Conditions for Broadcast Products“.		

1.6 kW Band 3 DAB/T-DMB Bandpass Filter

- Mask filter for DAB and T-DMB
- For 1.54 MHz block bandwidth
- With cross coupling (notch function)
- Tuneable within band 3
- Temperature compensated
- DC block
- Installation standing

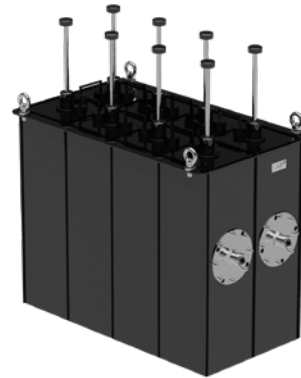

Bandpass Filters

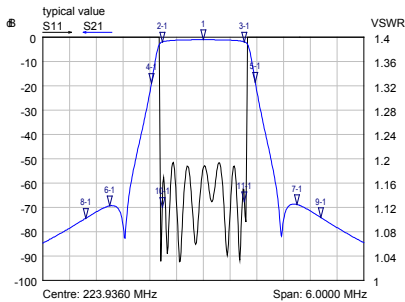

Typical diagram AS8027

Part Number	BN 617183
Frequency range	170 - 240 MHz
Number/size of cavities	8/150
Harmonics attenuation	≥ 50 dB for $f \leq 500$ MHz
Mask filtering	DAB / T-DMB @ 1.54 MHz ($\dot{U}/U_{rms} = 13$ dB)
Average input power	≤ 1.6 kW
Tuning instruction	AS8027
Insertion loss & mask filtering (alternative tuning on request)	$f_0 \leq 1.20$ dB $f_0 \pm 0.77 \leq 2.10$ dB $f_0 \pm 0.97 \geq 15.0$ dB $f_0 \pm 1.75 \geq 45.0$ dB $f_0 \pm 2.20 \geq 65.0$ dB $f_0 \pm 3.00 \geq 80.0$ dB
VSWR (passband range)	≤ 1.2
Group delay variation	$\Delta\tau \leq 1000$ ns
Temperature stability	≤ 1 kHz / K
Connectors	7-16 female
Dimensions (L x W x H) mm	615 x 347 x 680
Weight	≈ 60 kg
Environmental conditions	For limitations see „Environmental Conditions for Broadcast Products“.

3 kW - 8 kW Band 3 DAB/T-DMB Bandpass Filters

- Mask filters for DAB and T-DMB
- For 1.54 MHz block bandwidth
- With cross coupling (notch function)
- Tuneable within band 3
- Temperature compensated
- DC block
- Installation standing
- Natural or liquid cooling

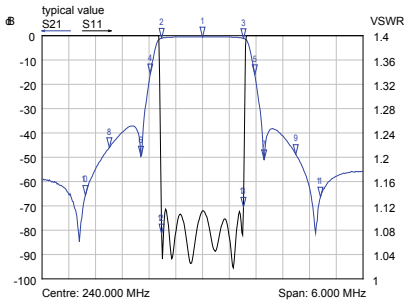
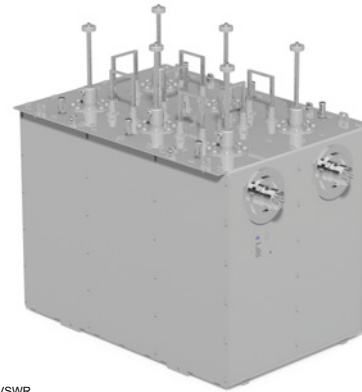

Typical diagram AS6019

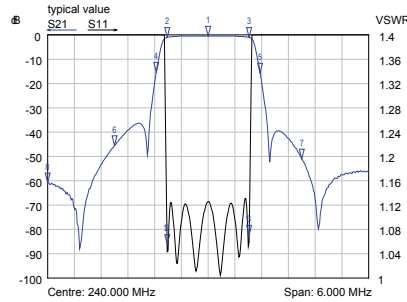

Typical diagram AS6087

Part Number	BN 617166C1031	BN 617166C2031	BN 617165C2031
Connector	1 5/8" SMS Unflanged BN 617166C1033 1 5/8" EIA	1 5/8" SMS Unflanged BN 617166C2033 1 5/8" EIA	1 5/8" SMS Unflanged BN 617165C2033 1 5/8" EIA
Cooling	Natural Cooling	Liquid Cooling	Liquid Cooling
Frequency range	174 - 240 MHz		
Number/size of cavities	6/200		
Harmonics attenuation	≥ 50 dB for f < 500 MHz		
Mask filtering	DAB / T-DMB @ 1.54 MHz ($\dot{U}/U_{rms} = 13$ dB)		
Average input power The input power of the filters must be reduced if installed more than 2300 m above sea level.	≤ 3.0 kW	≤ 5.5 kW @ 0 - 500 m ≤ 4.8 kW @ 1400 m ≤ 4.3 kW @ 2100 m ≤ 3.8 kW @ 2800 m ≤ 3.2 kW @ 3600 m	≤ 8.0 kW @ 0 - 500 m ≤ 7.1 kW @ 1400 m ≤ 6.3 kW @ 2100 m ≤ 5.5 kW @ 2800 m ≤ 4.7 kW @ 3600 m
Tuning instruction	AS6019	AS6087	
Insertion loss & mask filtering (alternative tuning on request)	$f_0 \leq 0.55$ dB $f_0 \pm 0.77 \leq 1.2$ dB $f_0 \pm 0.97 \leq 12$ dB $f_0 \pm 1.15 \leq 30$ dB $f_0 \pm 1.75 \leq 40$ dB $f_0 \pm 2.20 \leq 55$ dB $f_0 \pm 3.00 \leq 55$ dB	$f_0 \leq 0.5$ dB $f_0 \pm 0.77 \leq 1.3$ dB $f_0 \pm 0.97 \leq 15$ dB $f_0 \pm 1.15$ n.d. $f_0 \pm 1.75 \leq 45$ dB $f_0 \pm 2.20 \leq 50$ dB $f_0 \pm 3.00 \geq 50$ dB	
VSWR (passband range)	≤ 1.15		
Group delay variation	$\Delta\tau \leq 1000$ ns	$\Delta\tau \leq 1200$ ns	
Temperature stability	≤ 1 kHz / K		
Dimensions (L x W x H) mm	600 x 450 x 685		
Weight	≈85 kg		
Temperature of the coolant	-	10 °C – 55 °C	
Coolant Flow rate	-	Mix: glycol and water BN 154567 ≥ 3 l/min	
Cooling accessories	-	See "Accessories for Fan- and Liquid-Cooled Filters"	
Cooling interface	-	Stainless steel tube 12 x 1mm unflanged ending straight (adapters available on request)	
Environmental conditions	For limitations see „Environmental Conditions for Broadcast Products“.		

3.1 kW - 8 kW Band 3 DAB/T-DMB Bandpass Filters

- Mask filters for DAB and T-DMB
- For 1.54 MHz block bandwidth
- With cross coupling (notch function)
- Tuneable within band 3
- Temperature compensated
- DC block
- Installation standing
- Natural or liquid cooling

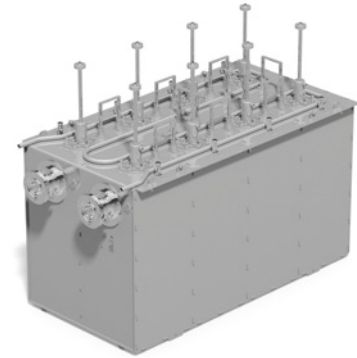

Bandpass Filters

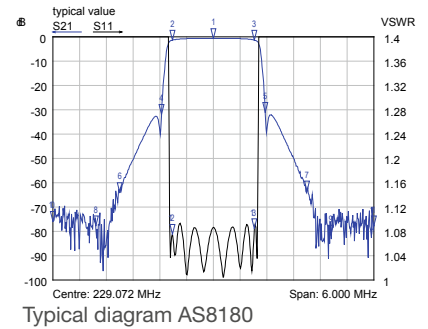
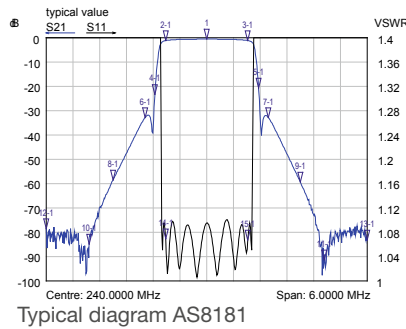
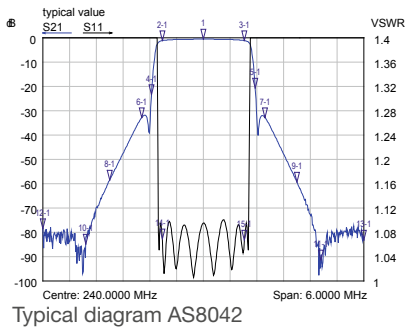

Part Number	BN 617168C1031	BN 617168C2031	BN 617167C2031
Connector	1 5/8" SMS Unflanged BN 617168C1033 1 5/8" EIA	1 5/8" SMS Unflanged BN 617168C2033 1 5/8" EIA	1 5/8" SMS Unflanged BN 617167C2033 1 5/8" EIA
Cooling	Natural Cooling	Liquid Cooling	Liquid Cooling
Frequency range	174 - 240 MHz		
Number/size of cavities	8/200		
Harmonics attenuation	≥ 50 dB for f < 500 MHz		
Mask filtering	DAB / T-DMB @ 1.54 MHz ($\dot{U}/U_{rms} = 13$ dB)		
Average input power The input power of the filters must be reduced if installed more than 2300 m above sea level.	≤ 3.1 kW	≤ 5.5 kW @ 0 - 500 m ≤ 4.8 kW @ 1400 m ≤ 4.3 kW @ 2100 m ≤ 3.8 kW @ 2800 m ≤ 3.2 kW @ 3600 m	≤ 8.0 kW @ 0 - 500 m ≤ 7.1 kW @ 1400 m ≤ 6.3 kW @ 2100 m ≤ 5.5 kW @ 2800 m ≤ 4.7 kW @ 3600 m
Tuning instruction	AS8042	AS8181	AS8180
Insertion loss & mask filtering (alternative tuning on request)	$f_0 \leq 0.60$ dB $f_0 \pm 0.77 \leq 1.20$ dB $f_0 \pm 0.97 \geq 15.0$ dB $f_0 \pm 1.15 \geq 30.0$ dB $f_0 \pm 1.75 \geq 50.0$ dB $f_0 \pm 2.20 \geq 65.0$ dB $f_0 \pm 3.00 \geq 65.0$ dB	$f_0 \leq 0.60$ dB $f_0 \pm 0.77 \leq 1.40$ dB $f_0 \pm 0.97 \geq 20.0$ dB $f_0 \pm 1.15 \geq 30.0$ dB $f_0 \pm 1.75 \geq 50.0$ dB $f_0 \pm 2.20 \geq 65.0$ dB $f_0 \pm 3.00 \geq 65.0$ dB	$f_0 \leq 0.65$ dB $f_0 \pm 0.77 \leq 1.45$ dB $f_0 \pm 0.97 \geq 28.0$ dB $f_0 \pm 1.15$ n.d. $f_0 \pm 1.75 \geq 61.0$ dB $f_0 \pm 2.20 \geq 69.0$ dB $f_0 \pm 3.00 \geq 70.0$ dB
VSWR (passband range)	≤ 1.10		
Group delay variation	$\Delta\tau \leq 1200$ ns		$\Delta\tau \leq 1300$ ns
Temperature stability	≤ 1 kHz / K		
Dimensions (L x W x H) mm	880 x 450 x 678		
Weight	≈ 105 kg		
Temperature of the coolant	-	10 °C – 55 °C	
Coolant Flow rate	-	Mix: glycol and water BN 154567 ≥ 3 l/min	
Cooling accessories	-	See "Accessories for Fan- and Liquid-Cooled Filters"	
Cooling interface	-	Stainless steel tube 12 x 1mm unflanged ending straight (adapters available on request)	
Environmental conditions	For limitations see „Environmental Conditions for Broadcast Products“.		

5 kW - 10 kW Band 3 DAB/T-DMB Bandpass Filters

- Mask filters for DAB and T-DMB
- For 1.54 MHz block bandwidth
- With cross coupling (notch function)
- Tuneable within band 3
- Temperature compensated
- DC block
- Installation standing
- Natural or liquid cooling

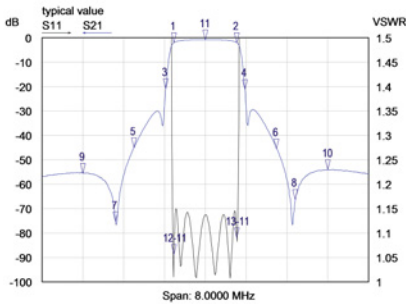
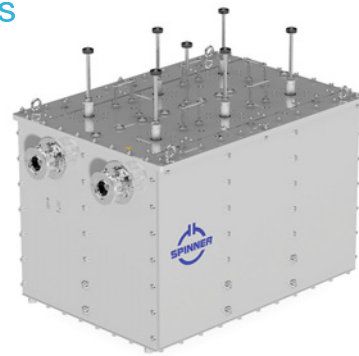

Typical diagram AS6525

Part Number	BN 617146C1033	BN 617146C2033
Cooling	Natural Cooling	Liquid Cooling
Frequency range	174 - 240 MHz	
Number/size of cavities	6/245	
Harmonics attenuation	≥ 50 dB for f < 460 MHz ≥ 40 dB for 460 - 480 MHz	
Mask filtering	DAB / T-DMB @ 1.54 MHz ($\hat{U}/U_{rms} = 13$ dB)	
Average input power	5 kW	10 kW
The input power of liquid cooled filters must be reduced if installed more than 2300 m above sea level.		
Tuning instruction	AS6525	
Insertion loss & mask filtering (alternative tuning on request)	$f_0 \leq 0.50$ dB $f_0 \pm 0.77 \leq 1.30$ dB $f_0 \pm 0.97 \geq 15.0$ dB $f_0 \pm 1.75 \geq 46.0$ dB $f_0 \pm 2.20 \geq 59.0$ dB $f_0 \pm 3.00 \geq 59.0$ dB	
VSWR (passband range)	≤ 1.17	
Group delay variation	$\Delta\tau \leq 1300$ ns	
Temperature stability	≤ 1 kHz / K	
Connectors	1 5/8" EIA	
Dimensions (L x W x H) mm	910 x 670 x 768	
Weight	≈ 130 kg	
Coolant/flow rate	–	Mix: glycol and water BN 154567 / ≥ 3 l/min
Temperature of the coolant	–	10 °C - 55 °C
Cooling interface	–	Aluminum pipe with hose barb 3/4" (adapters available on request)
Cooling accessories	–	See "Accessories for Fan- and Liquid-Cooled Filters"
Environmental conditions	For limitations see „Environmental Conditions for Broadcast Products“.	

5 kW - 10 kW Band 3 DAB/T-DMB Bandpass Filters

- Mask filters for DAB and T-DMB
- For 1.54 MHz block bandwidth
- With cross coupling (notch function)
- Tuneable within band 3
- Temperature compensated
- DC block
- Installation standing
- Natural or liquid cooling

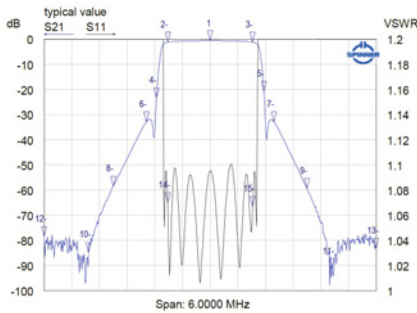

Typical diagram AS8164

Part Number Cooling	BN 617148C1033 Natural Cooling	BN 617148C2033 Liquid Cooling
Frequency range	174 - 240 MHz	
Number/size of cavities	8/245	
Harmonics attenuation	≥ 50 dB for f < 460 MHz ≥ 40 dB for 460 - 480 MHz	
Mask filtering	DAB / T-DMB @ 1.54 MHz ($\dot{U}/U_{rms} = 13$ dB)	
Average input power The input power of liquid cooled filters must be reduced if installed more than 2300 m above sea level.	5 kW	10 kW
Tuning instruction	AS8164	
Insertion loss & mask filtering (alternative tuning on request)	$f_0 \leq 0.60$ dB $f_0 \pm 0.77 \leq 1.40$ dB $f_0 \pm 0.97 \geq 18.0$ dB $f_0 \pm 1.75 \geq 50.0$ dB $f_0 \pm 2.20 \geq 70.0$ dB $f_0 \pm 3.00 \geq 70.0$ dB	
VSWR (passband range)	≤ 1.15	
Group delay variation	$\Delta\tau \leq 1200$ ns	
Temperature stability	≤ 1 kHz / K	
Connectors	1 5/8" EIA	
Dimensions (L x W x H) mm	1165 x 670 x 768	
Weight	≈ 160 kg	
Coolant/flow rate	–	Mix: glycol and water BN 154567 / ≥ 3 l/min
Temperature of the coolant	–	10 °C - 55 °C
Cooling interface	–	Aluminum pipe with hose barb 3/4" (adapters available on request)
Cooling accessories	–	See "Accessories for Fan- and Liquid-Cooled Filters"
Environmental conditions	For limitations see „Environmental Conditions for Broadcast Products“.	

900 W - 1100 W Band 3 DTV Bandpass Filter

- Mask filter for ATV and DTV
- For 6, 7 and 8 MHz channel bandwidth
- With cross coupling (notch function)
- Tuneable within band 3
- Temperature compensated
- DC block
- Installation standing

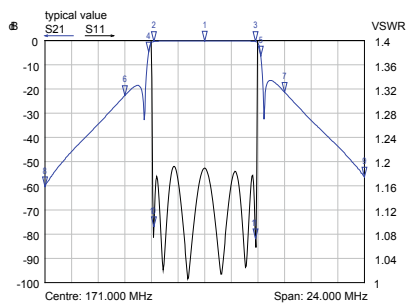

Typical diagram AS6164

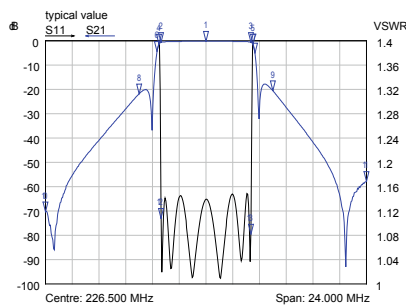

Typical diagram AS6162

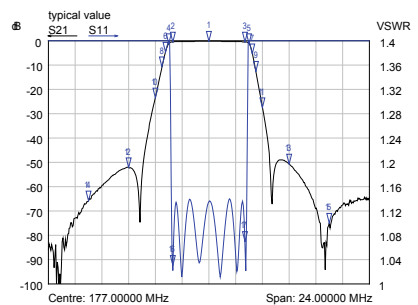

Typical diagram AS6161

Part Number	BN 617190C0010		
Frequency range	174 - 230 MHz		
Number/size of cavities	6/100		
Harmonics attenuation	≥ 50 dB for f ≤ 500 MHz		
Mask filtering	DVB-T @ 8 MHz ($\dot{U}/U_{rms} = 13$ dB)	DVB-T @ 7 MHz ($\dot{U}/U_{rms} = 13$ dB)	ATSC 1.0 @ 6 MHz ($\dot{U}/U_{rms} = 11$ dB)
Average input power	≤ 1.1 kW	≤ 1.0 kW	≤ 900 W
Tuning instruction	AS6164	AS6162	AS6161
Insertion loss & mask filtering (alternative tuning on request)	$f_0 \leq 0.25$ dB $f_0 \pm 0.3805 \leq 0.65$ dB $f_0 \pm 4.20 \geq 4.00$ dB $f_0 \pm 6.00 \geq 20.0$ dB $f_0 \pm 12.0 \geq 55.0$ dB	$f_0 \leq 0.25$ dB $f_0 \pm 3.35 \leq 0.70$ dB $f_0 \pm 3.50 \geq 1.20$ dB $f_0 \pm 3.65 \geq 4.00$ dB $f_0 \pm 5.00 \geq 20.0$ dB $f_0 \pm 12.0 \geq 55.0$ dB	$f_0 \leq 0.30$ dB $f_0 \pm 2.69 \leq 0.50$ dB $f_0 \pm 3.00 \geq 1.10$ dB $f_0 \pm 3.50 \geq 8.00$ dB $f_0 \pm 4.00 \geq 15.0$ dB $f_0 \pm 6.00 \geq 30.0$ dB $f_0 \pm 9.00 \geq 64.0$ dB
VSWR (passband range)	≤ 1.22	≤ 1.17	≤ 1.15
Group delay variation	$\Delta\tau \leq 350$ ns	$\Delta\tau \leq 350$ ns	$\Delta\tau \leq 220$ ns
Temperature stability	≤ 2 kHz / K		
Connectors	7-16 female		
Dimensions (L x W x H) mm	382 x 244 x 590		
Weight	≈ 25 kg		
Environmental conditions	For limitations see „Environmental Conditions for Broadcast Products“.		

2.5 kW - 5.2 kW Band 3 DTV Bandpass Filters

- Masks filters for ATV and DTV
- For 6, 7 and 8 MHz channel bandwidth
- With cross coupling (notch function)
- Tuneable within band 3
- Temperature compensated
- DC block
- Installation standing

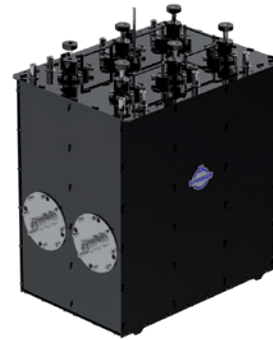

Bandpass Filters

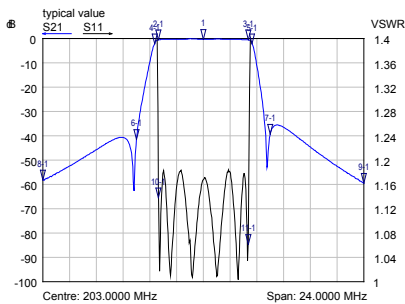

Typical diagram AS6044

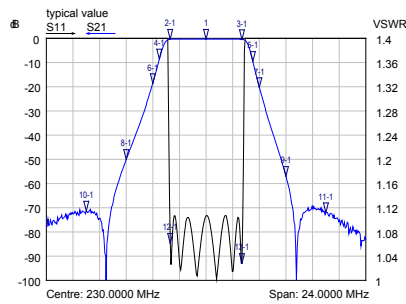

Typical diagram AS6079

Part Number	BN 617126	BN 617126C0010	BN 617126C4033 Fan Cooled
Frequency range	174 - 230 MHz		
Number/size of cavities	6/150		
Mask filtering	DVB-T @ 7 MHz ($\dot{U}/U_{rms} = 13$ dB)		ATSC 1.0 @ 6 MHz ($\dot{U}/U_{rms} = 11$ dB)
Average input power	≤ 2.5 kW BN 617126 ≤ 4.0 kW BN 617126C0010 ≤ 5.2 kW BN 617126C4033 @ 0 - 500 m		≤ 2.5 kW BN 617126 ≤ 3.6 kW BN 617126C0010 ≤ 4.5 kW BN 617126C4033 @ 0 - 500 m
Tuning instruction	AS6044		AS6079
Insertion loss & mask filtering (alternative tuning on request)	$f_0 \leq 0.30$ dB $f_0 \pm 3.35 \leq 0.60$ dB $f_0 \pm 3.50 \geq 0.70$ dB $f_0 \pm 3.65 \geq 2.00$ dB $f_0 \pm 5.00 \geq 35.0$ dB $f_0 \pm 12.0 \geq 55.0$ dB		$f_0 \leq 0.35$ dB $f_0 \pm 2.69 \leq 0.60$ dB $f_0 \pm 3.00 \geq 1.30$ dB $f_0 \pm 3.50 \geq 5.00$ dB $f_0 \pm 4.00 \geq 11.0$ dB $f_0 \pm 6.00 \geq 30.0$ dB $f_0 \pm 9.00 \geq 65.0$ dB
VSWR (passband range)	≤ 1.20		≤ 1.15
Group delay variation	$\Delta\tau \leq 300$ ns		$\Delta\tau \leq 200$ ns
Temperature stability	≤ 2 kHz / K		
Connectors	7-16 female		1 5/8" EIA
Dimensions (L x W x H) mm	461 x 326 x 681		516 x 347 x 681
Weight	≈ 42 kg		≈ 45 kg
Environmental conditions	For limitations see „Environmental Conditions for Broadcast Products“.		

3.5 kW Band 3 DTV Bandpass Filters

- Mask filters for ATV and DTV
- For 6, 7 and 8 MHz channel bandwidth
- With cross coupling (notch function)
- Tuneable within band 3
- Temperature compensated
- DC block
- Installation standing

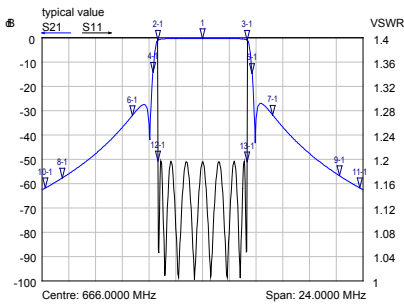
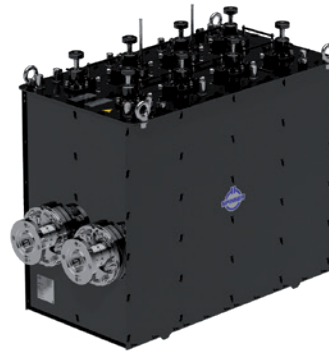

Typical diagram AS8049

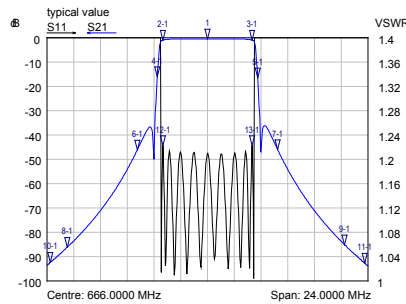

Typical diagram AS1001

Part Number	BN 617191	BN 617193
Frequency range	174 - 230 MHz	
Number/size of cavities	8/150	10/150
Mask filtering	DVB-T @ 7 MHz ($\dot{U}/U_{rms} = 13$ dB)	
Average input power	≤ 3.5 kW	
Tuning instruction	AS8049	AS1001
Insertion loss & mask filtering (alternative tuning on request)	$f_0 \leq 0.35$ dB $f_0 \pm 3.35 \leq 0.85$ dB $f_0 \pm 3.70 \geq 15.0$ dB $f_0 \pm 5.25 \geq 30.0$ dB $f_0 \pm 10.50 \geq 50.0$ dB $f_0 \pm 11.75 \geq 55.0$ dB	$f_0 \leq 0.50$ dB $f_0 \pm 3.35 \leq 1.60$ dB $f_0 \pm 3.70 \geq 15.0$ dB $f_0 \pm 5.25 \geq 40.0$ dB $f_0 \pm 10.50 \geq 65.0$ dB $f_0 \pm 11.75 \geq 70.0$ dB
VSWR (passband range)	≤ 1.20	≤ 1.22
Group delay variation	$\Delta\tau \leq 600$ ns	$\Delta\tau \leq 800$ ns
Temperature stability	≤ 2 kHz / K	
Connectors	1 5/8" EIA	
Dimensions (L x W x H) mm	650 x 326 x 680	804 x 348 x 683
Weight	≈ 68 kg	≈ 89 kg
Environmental conditions	For limitations see „Environmental Conditions for Broadcast Products“.	

40 W - 50 W UHF DTV Bandpass Filter

- Mask filter for ATV and DTV
- For 6, 7 and 8 MHz channel bandwidth
- Without cross coupling
- Tuneable within whole UHF range
- Temperature compensated
- DC block
- Installation horizontally or vertically



Bandpass Filters

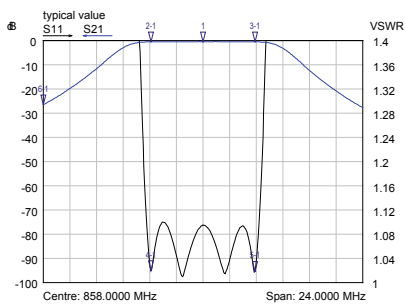

Typical diagram AS4054

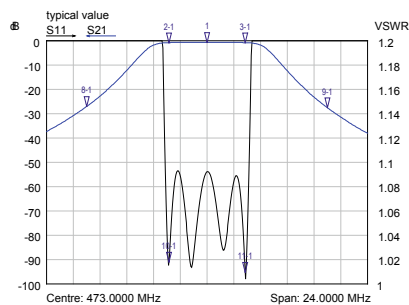

Typical diagram AS4029

Part Number	BN 616507	
Frequency range	470 - 860 MHz	
Number/size of cavities	4/34	
Harmonics attenuation	≥ 50 dB for f ≤ 1500 MHz	
TV standard	DVB-T or ATV @ 8 MHz ($\dot{U}/U_{rms} = 13$ dB)	DVB-T or ATV @ 6 MHz ($\dot{U}/U_{rms} = 13$ dB)
Average input power	≤ 50 W	≤ 40 W
Tuning instruction	AS4054	AS4029
Insertion loss & mask filtering (alternative tuning on request)	470 MHz 860 MHz	470 MHz 803 MHz
	f_0 ≤ 0.7 dB ≤ 0.6 dB	f_0 ≤ 0.8 dB ≤ 0.7 dB
	$f_0 \pm 3.805$ ≤ 0.8 dB ≤ 0.7 dB	$f_0 \pm 2.855$ ≤ 0.9 dB ≤ 0.8 dB
	$f_0 \pm 3.885$ ≤ 0.8 dB ≤ 0.7 dB	$f_0 \pm 9.0$ ≥ 25 dB
	$f_0 \pm 12.0$ ≥ 17 dB	
VSWR (passband range)	≤ 1.10	≤ 1.10
Group delay variation	$\Delta\tau \leq 100$ ns	$\Delta\tau \leq 30$ ns
Temperature stability	≤ 10 kHz / K	
Connectors	N female	
Dimensions (L x W x H) mm	277 x 44 x 135	
Weight	≈ 2 kg	
Environmental conditions	For limitations see „Environmental Conditions for Broadcast Products“.	

100 W - 130 W UHF DTV Bandpass Filter

- Mask filter for ATV and DTV
- For 6, 7 and 8 MHz channel bandwidth
- With cross coupling (notch function)
- Tuneable within whole UHF range
- Temperature compensated
- DC block
- Installation horizontally or vertically
- Low profile design

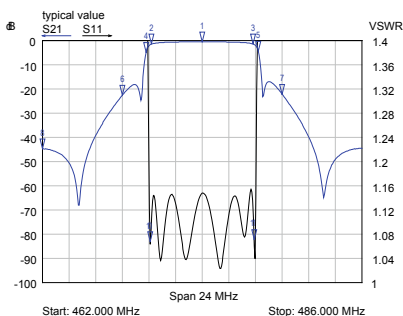

Typical diagram AS6361

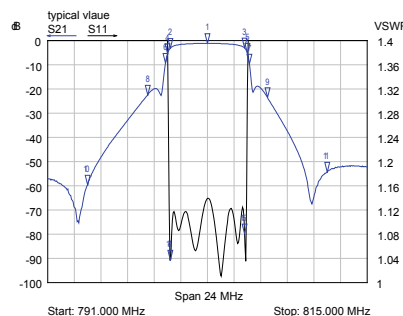

Typical diagram AS6368

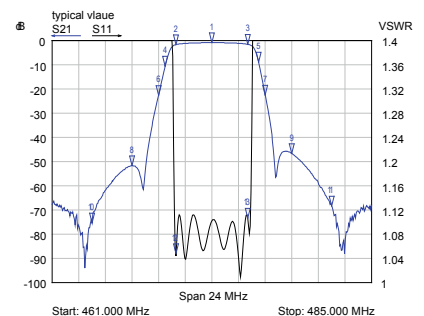

Typical diagram AS6362

Part Number	BN 616660C1025								
Frequency range	470 - 860 MHz								
Number/size of cavities	6/40								
Harmonics attenuation	≥ 50 dB for $f \leq 1400$ MHz								
TV standard	DVB-T @ 8 MHz ($\dot{U}/U_{rms} = 13$ dB)		ISDB-T @ 6 MHz ($\dot{U}/U_{rms} = 13$ dB)		ATSC 1.0 @ 6 MHz ($\dot{U}/U_{rms} = 11$ dB)				
Average input power	≤ 130 W		≤ 100 W		≤ 100 W				
Tuning instruction	AS6361		AS6368		AS6362				
Insertion loss & mask filtering (alternative tuning on request)	470 MHz	860 MHz	470 MHz	803 MHz	470 MHz	803 MHz			
	f_0	≤ 0.7 dB	≤ 0.9 dB	f_0	≤ 1.0 dB	≤ 1.3 dB	f_0	≤ 1.2 dB	≤ 1.7 dB
	$f_0 \pm 3.805$	≤ 1.9 dB	≤ 2.4 dB	$f_0 \pm 2.79$	≤ 2.6 dB	≤ 3.2 dB	$f_0 \pm 2.69$	≤ 2.2 dB	≤ 2.6 dB
	$f_0 \pm 3.885$	≤ 2.2 dB	≤ 2.7 dB	$f_0 \pm 3.00$	≥ 4 dB		$f_0 \pm 3.25$	≥ 4 dB	
	$f_0 \pm 4.2$	≥ 4 dB		$f_0 \pm 3.15$	≥ 8 dB		$f_0 \pm 3.50$	≥ 8 dB	
	$f_0 \pm 6.0$	≥ 20 dB		$f_0 \pm 4.50$	≥ 22 dB		$f_0 \pm 4.0$	≥ 15 dB	
	$f_0 \pm 12.0$	≥ 40 dB		$f_0 \pm 9.00$	≥ 50 dB		$f_0 \pm 6.0$	≥ 40 dB	
				$f_0 \pm 15.0$	≥ 50 dB		$f_0 \pm 9.0$	≥ 65 dB	
VSWR (passband range)	≤ 1.15		≤ 1.15		≤ 1.15				
Group delay variation	$\Delta\tau \leq 350$ ns		$\Delta\tau \leq 350$ ns		$\Delta\tau \leq 200$ ns				
Temperature stability	≤ 2 kHz / K								
Connector	7-16 female								
Dimensions (L x W x H) mm	185 x 170 x 94								
Weight	≈ 2.8 kg								
Environmental conditions	For limitations see „Environmental Conditions for Broadcast Products“.								

100 W - 120 W UHF DTV Bandpass Filter

- Mask filter for ATV and DTV
- For 6, 7 and 8 MHz channel bandwidth
- With cross coupling (notch function)
- Tuneable within whole UHF range
- Temperature compensated
- DC block
- Installation horizontally or vertically
- Low profile design

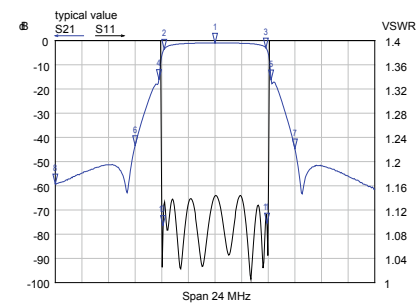
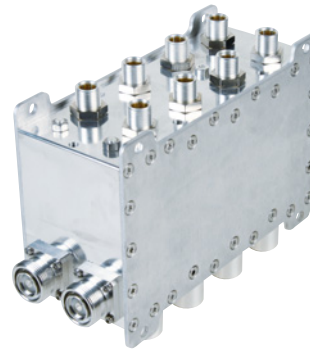

Typical diagram AS8131

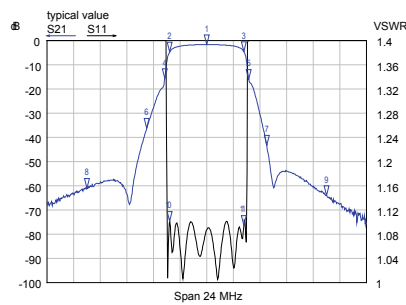

Typical diagram AS8133

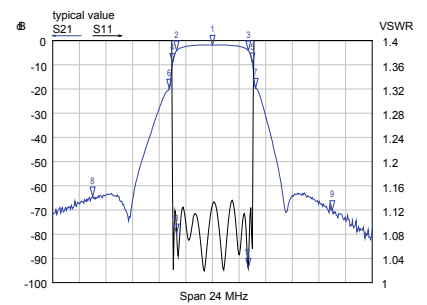

Typical diagram AS8132

Bandpass Filters

Part Number	BN 616661C1025		
Frequency range	470 - 860 MHz		
Number/size of cavities	8/40		
Harmonics attenuation	≥ 50 dB for f ≤ 1400 MHz		
TV standard	DVB-T @ 8 MHz ($\dot{U}/U_{rms} = 13$ dB)	ISDB-T @ 6 MHz ($\dot{U}/U_{rms} = 13$ dB)	ATSC 1.0 @ 6 MHz ($\dot{U}/U_{rms} = 11$ dB)
Average input power	≤ 120 W	≤ 100 W	≤ 100 W
Tuning instruction	AS8131	AS8133	AS8132
Insertion loss & mask filtering (alternative tuning on request)	470 MHz 860 MHz	470 MHz 803 MHz	470 MHz 803 MHz
	f_0 ≤ 1.1 dB ≤ 1.5 dB	f_0 ≤ 1.4 dB ≤ 1.75 dB	f_0 ≤ 1.5 dB ≤ 1.9 dB
	$f_0 \pm 3.805$ ≤ 3.6 dB ≤ 5.2 dB	$f_0 \pm 2.79$ ≤ 4.4 dB ≤ 5.00 dB	$f_0 \pm 2.69$ ≤ 3.8 dB ≤ 4.4 dB
	$f_0 \pm 3.885$ ≤ 4.4 dB ≤ 5.8 dB	$f_0 \pm 3.15$ ≥ 15 dB	$f_0 \pm 3.25$ ≥ 5 dB
	$f_0 \pm 4.2$ ≥ 15 dB	$f_0 \pm 4.50$ ≥ 30 dB	$f_0 \pm 3.50$ ≥ 18 dB
	$f_0 \pm 6.0$ ≥ 40 dB	$f_0 \pm 9.00$ ≥ 55 dB	$f_0 \pm 9.0$ ≥ 64 dB
	$f_0 \pm 12.0$ ≥ 55 dB	$f_0 \pm 15.0$ ≥ 65 dB	
VSWR (passband range)	≤ 1.15	≤ 1.11	≤ 1.15
Group delay variation	$\Delta\tau \leq 600$ ns	$\Delta\tau \leq 500$ ns	$\Delta\tau \leq 400$ ns
Temperature stability	≤ 2 kHz / K		
Connector	7-16 female		
Dimensions (L x W x H) mm	230 x 170 x 94		
Weight	≈ 3.5 kg		
Environmental conditions	For limitations see „Environmental Conditions for Broadcast Products“.		

300 W - 375 W UHF DTV Bandpass Filter

- Mask filter for ATV and DTV
- For 6, 7 and 8 MHz channel bandwidth
- With cross coupling (notch function)
- Tuneable within whole UHF range
- Temperature compensated
- DC block
- Installation horizontally or vertically
- Low profile design

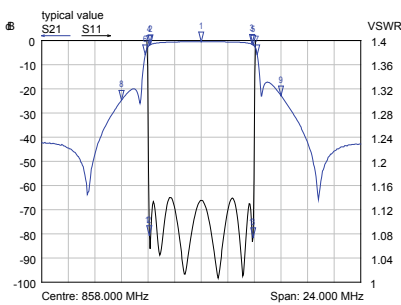

Typical diagram AS6201

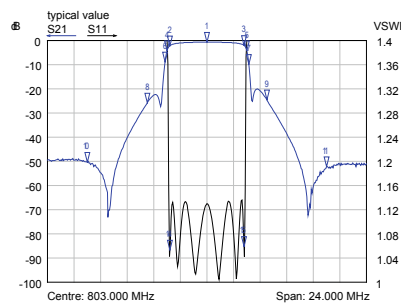

Typical diagram AS6192

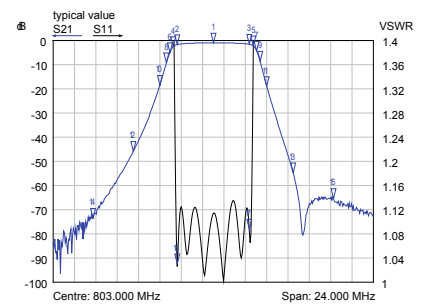

Typical diagram AS6257

Part Number	BN 616566C1025								
Frequency range	470 - 860 MHz								
Number/size of cavities	6/60								
Harmonics attenuation	≥ 50 dB for $f \leq 1200$ MHz								
TV standard	DVB-T @ 8 MHz ($\dot{U}/U_{rms} = 13$ dB)		ISDB-T @ 6 MHz ($\dot{U}/U_{rms} = 13$ dB)		ATSC 1.0 @ 6 MHz ($\dot{U}/U_{rms} = 11$ dB)				
Average input power	≤ 375 W		≤ 300 W		≤ 300 W				
Tuning instruction	AS6201		AS6192		AS6257				
Insertion loss & mask filtering (alternative tuning on request)	470 MHz	860 MHz	470 MHz	803 MHz	470 MHz	803 MHz			
	f_0	≤ 0.45 dB	≤ 0.55 dB	f_0	≤ 0.6 dB	≤ 0.75 dB	f_0	≤ 0.7 dB	≤ 1.0 dB
	$f_0 \pm 3.805$	≤ 1.25 dB	≤ 1.75 dB	$f_0 \pm 2.79$	≤ 1.6 dB	≤ 2.20 dB	$f_0 \pm 2.69$	≤ 1.4 dB	≤ 1.7 dB
	$f_0 \pm 3.885$	≤ 1.45 dB	≤ 2.00 dB	$f_0 \pm 3.00$	≥ 4 dB		$f_0 \pm 3.0$	≤ 2.6 dB	≤ 2.7 dB
	$f_0 \pm 4.2$	≥ 4 dB		$f_0 \pm 3.15$	≥ 8 dB		$f_0 \pm 3.25$	≥ 4 dB	
	$f_0 \pm 6.0$	≥ 20 dB		$f_0 \pm 4.50$	≥ 23 dB		$f_0 \pm 3.5$	≥ 8 dB	
	$f_0 \pm 12.0$	≥ 40 dB		$f_0 \pm 9.00$	≥ 48 dB		$f_0 \pm 4.0$	≥ 15 dB	
				$f_0 \pm 15.0$	≥ 50 dB		$f_0 \pm 6.0$	≥ 40 dB	
							$f_0 \pm 9.0$	≥ 65 dB	
VSWR (passband range)	≤ 1.15		≤ 1.15		≤ 1.15				
Group delay variation	$\Delta\tau \leq 350$ ns		$\Delta\tau \leq 350$ ns		$\Delta\tau \leq 200$ ns				
Temperature stability	≤ 2 kHz / K								
Connectors	7-16 female								
Dimensions (L x W x H) mm	260 x 129 x 175								
Weight	≈ 6 kg								
Environmental conditions	For limitations see „Environmental Conditions for Broadcast Products“.								

300 W - 375 W UHF DTV Bandpass Filter

- Mask filter for ATV and DTV
- For 6, 7 and 8 MHz channel bandwidth
- With cross coupling (notch function)
- Tuneable within whole UHF range
- Temperature compensated
- DC block
- Installation horizontally or vertically
- Low profile design

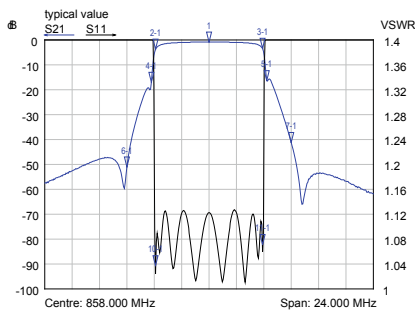

Typical diagram AS8087

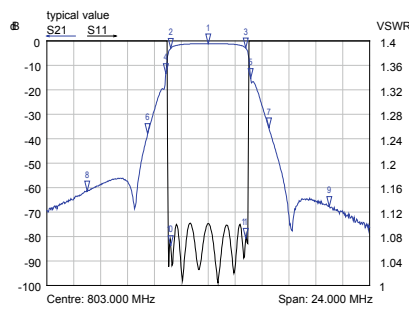

Typical diagram AS8095

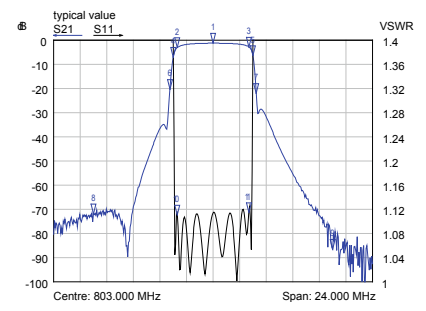

Typical diagram AS8084

Bandpass Filters

Part Number	BN 616568C1025		
Frequency range	470 - 860 MHz		
Number/size of cavities	8/60		
Harmonics attenuation	≥ 50 dB for f ≤ 1200 MHz		
TV standard	DVB-T @ 8 MHz ($\dot{U}/U_{rms} = 13$ dB)	ISDB-T @ 6 MHz ($\dot{U}/U_{rms} = 13$ dB)	ATSC 1.0 @ 6 MHz ($\dot{U}/U_{rms} = 11$ dB)
Average input power	≤ 375 W	≤ 300 W	≤ 300 W
Tuning instruction	AS8087	AS8095	AS8084
Insertion loss & mask filtering (alternative tuning on request)	470 MHz 860 MHz	470 MHz 803 MHz	470 MHz 803 MHz
f_0	≤ 0.65 dB ≤ 0.90 dB	f_0 ≤ 0.75 dB ≤ 1.05 dB	f_0 ≤ 0.9 dB ≤ 1.2 dB
$f_0 \pm 3.805$	≤ 2.25 dB ≤ 3.05 dB	$f_0 \pm 2.79$ ≤ 2.15 dB ≤ 3.10 dB	$f_0 \pm 2.69$ ≤ 2.25 dB ≤ 2.75 dB
$f_0 \pm 3.885$	≤ 2.95 dB ≤ 3.75 dB	$f_0 \pm 3.15$ ≥ 15 dB	$f_0 \pm 3.0$ ≥ 4 dB
$f_0 \pm 4.2$	≥ 15 dB	$f_0 \pm 4.5$ ≥ 30 dB	$f_0 \pm 3.25$ ≥ 18 dB
$f_0 \pm 6.0$	≥ 40 dB	$f_0 \pm 9.0$ ≥ 55 dB	$f_0 \pm 9.0$ ≥ 64 dB
$f_0 \pm 12.0$	≥ 55 dB		
VSWR (passband range)	≤ 1.15	≤ 1.11	≤ 1.15
Group delay variation	$\Delta\tau \leq 660$ ns	$\Delta\tau \leq 500$ ns	$\Delta\tau \leq 420$ ns
Temperature stability	≤ 2 kHz / K		
Connectors	7-16 female		
Dimensions (L x W x H) mm	322 x 129 x 175		
Weight	≈ 7.6 kg		
Environmental conditions	For limitations see „Environmental Conditions for Broadcast Products“.		

600 W - 750 W UHF DTV Bandpass Filter

- Mask filter for ATV and DTV
- For 6, 7 and 8 MHz channel bandwidth
- With cross coupling (notch function)
- Tuneable within whole UHF range
- Temperature compensated
- DC block
- Installation horizontally or vertically
- Low profile design

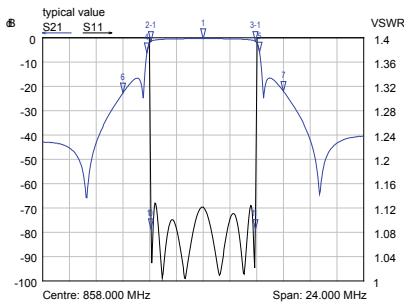

Typical diagram AS6186

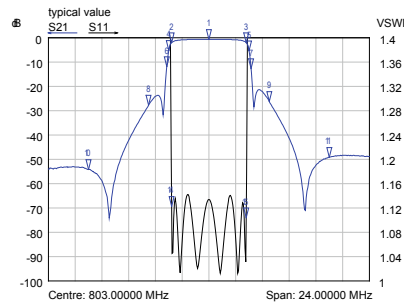

Typical diagram AS6182

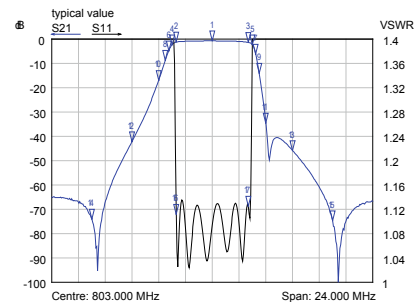

Typical diagram AS6156

Part Number	BN 616402			
Frequency range	470 - 860 MHz			
Number/size of cavities	6/84			
Harmonics attenuation	≥ 50 dB for f ≤ 950 MHz			
TV standard	DVB-T @ 8 MHz ($\dot{U}/U_{ms} = 13$ dB)		ISDB-T @ 6 MHz ($\dot{U}/U_{ms} = 13$ dB)	
Average input power	≤ 750 W		≤ 600 W	
Tuning instruction	AS6186		AS6182	
Insertion loss & mask filtering (alternative tuning on request)	470 MHz 860 MHz		470 MHz 803 MHz	
	f_0	≤ 0.4 dB ≤ 0.5 dB	f_0	≤ 0.5 dB ≤ 0.7 dB
	$f_0 \pm 3.805$	≤ 1.1 dB ≤ 1.4 dB	$f_0 \pm 2.79$	≤ 1.5 dB ≤ 2.1 dB
	$f_0 \pm 3.885$	≤ 1.2 dB ≤ 1.5 dB	$f_0 \pm 3.00$	≥ 4 dB
	$f_0 \pm 4.2$	≥ 4 dB	$f_0 \pm 3.15$	≥ 8 dB
	$f_0 \pm 6.0$	≥ 20 dB	$f_0 \pm 4.5$	≥ 23 dB
	$f_0 \pm 12.0$	≥ 40 dB	$f_0 \pm 9.0$	≥ 48 dB
			$f_0 \pm 15.0$	≥ 50 dB
			$f_0 \pm 3.0$	≤ 1.8 dB ≤ 2.35 dB
			$f_0 \pm 3.25$	≥ 4 dB
			$f_0 \pm 3.5$	≥ 8 dB
			$f_0 \pm 4.0$	≥ 15 dB
			$f_0 \pm 6.0$	≥ 40 dB
			$f_0 \pm 9.0$	≥ 65 dB
VSWR (passband range)	≤ 1.15		≤ 1.15	
Group delay variation	$\Delta\tau \leq 330$ ns		$\Delta\tau \leq 500$ ns	
Temperature stability	≤ 2 kHz / K			
Connectors	7-16 female			
Dimensions (L x W x H) mm	328 x 174 x 377			
Weight	≈ 11 kg			
Environmental conditions	For limitations see „Environmental Conditions for Broadcast Products“.			

600 W - 750 W UHF DTV Bandpass Filter

- Mask filter for ATV and DTV
- For 6, 7 and 8 MHz channel bandwidth
- With cross coupling (notch function)
- Tuneable within whole UHF range
- Temperature compensated
- DC block
- Installation horizontally or vertically
- Low profile design



Bandpass Filters

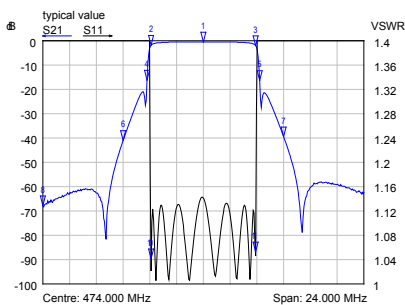

Typical diagram AS8068

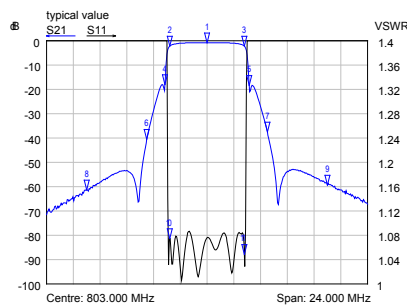

Typical diagram AS8091

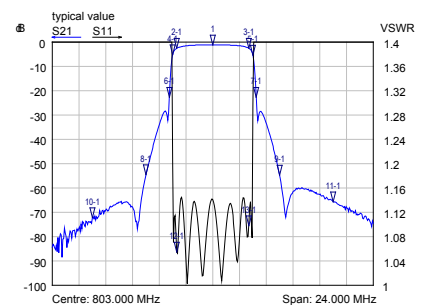

Typical diagram AS8051

Part Number	BN 616403		
Frequency range	470 - 860 MHz		
Number/size of cavities	8/84		
Harmonics attenuation	≥ 50 dB for f ≤ 950 MHz		
TV standard	DVB-T @ 8 MHz ($\dot{U}/U_{rms} = 13$ dB)	ISDB-T @ 6 MHz ($\dot{U}/U_{rms} = 13$ dB)	ATSC 1.0 @ 6 MHz ($\dot{U}/U_{rms} = 11$ dB)
Average input power	≤ 750 W	≤ 600 W	≤ 600 W
Tuning instruction	AS8068	AS8091	AS8051
Insertion loss & mask filtering (alternative tuning on request)	470 MHz 860 MHz	470 MHz 803 MHz	470 MHz 803 MHz
f_0	≤ 0.5 dB ≤ 0.65 dB	f_0 ≤ 0.6 dB ≤ 1.2 dB	f_0 ≤ 0.8 dB ≤ 1.2 dB
$f_0 \pm 3.805$	≤ 1.7 dB ≤ 2.10 dB	$f_0 \pm 2.79$ ≤ 1.7 dB ≤ 3.0 dB	$f_0 \pm 2.69$ ≤ 1.8 dB ≤ 2.6 dB
$f_0 \pm 3.885$	≤ 2.0 dB ≤ 2.50 dB	$f_0 \pm 3.15$ ≥ 15 dB	$f_0 \pm 3.00$ ≥ 3 dB
$f_0 \pm 4.20$	≥ 15 dB	$f_0 \pm 4.50$ ≥ 30 dB	$f_0 \pm 3.25$ ≥ 18 dB
$f_0 \pm 6.00$	≥ 40 dB	$f_0 \pm 9.00$ ≥ 55 dB	$f_0 \pm 9.00$ ≥ 64 dB
$f_0 \pm 12.0$	≥ 55 dB		
VSWR (passband range)	≤ 1.15	≤ 1.11	≤ 1.15
Group delay variation	$\Delta\tau \leq 600$ ns	$\Delta\tau \leq 500$ ns	$\Delta\tau \leq 400$ ns
Temperature stability	≤ 2 kHz / K		
Connectors	7-16 female		
Dimensions (L x W x H) mm	411 x 174 x 377		
Weight	≈ 14 kg		
Environmental conditions	For limitations see „Environmental Conditions for Broadcast Products“.		

1.3 kW - 1.6 kW UHF DTV Bandpass Filters

- Mask filters for ATV and DTV
- For 6, 7 and 8 MHz channel bandwidth
- With cross coupling (notch function)
- Tuneable within whole UHF range
- Temperature compensated
- DC block
- Installation horizontally or vertically
- Low profile design

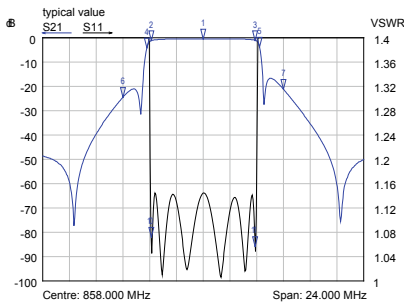

Typical diagram AS6224

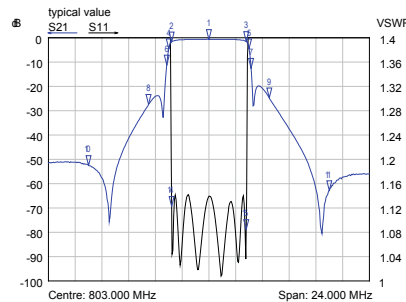

Typical diagram AS6229

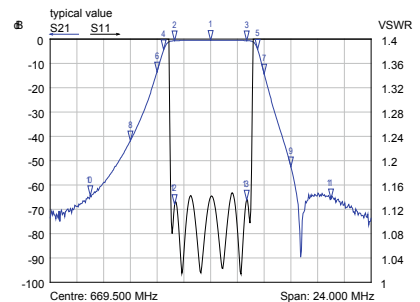

Typical diagram AS6228

Part Number	BN 616663C1031		BN 616663C1033	
Frequency range	470 - 860 MHz			
Number/size of cavities	6/120			
Harmonics attenuation	≥ 50 dB for f ≤ 1100 MHz			
TV standard	DVB-T @ 8 MHz ($\dot{U}/U_{rms} = 13$ dB)		ISDB-T @ 6 MHz ($\dot{U}/U_{rms} = 13$ dB)	
Average input power	≤ 1.6 kW		≤ 1.3 kW	
Tuning instruction	AS6224		AS6229	
Insertion loss & mask filtering (alternative tuning on request)	470 MHz 860 MHz		470 MHz 803 MHz	
	f_0	≤ 0.3 dB ≤ 0.4 dB	f_0	≤ 0.35 dB ≤ 0.5 dB
	$f_0 \pm 3.805$	≤ 0.8 dB ≤ 1.1 dB	$f_0 \pm 2.79$	≤ 1.10 dB ≤ 1.4 dB
	$f_0 \pm 3.885$	≤ 0.9 dB ≤ 1.3 dB	$f_0 \pm 3.00$	≥ 3 dB
	$f_0 \pm 4.2$	≥ 4 dB	$f_0 \pm 3.15$	≥ 5 dB
	$f_0 \pm 6.0$	≥ 20 dB	$f_0 \pm 4.50$	≥ 17 dB
	$f_0 \pm 12.0$	≥ 40 dB	$f_0 \pm 9.00$	≥ 38 dB
		$f_0 \pm 15.0$	≥ 48 dB	
VSWR (passband range)	≤ 1.15		≤ 1.15	
Group delay variation	$\Delta\tau \leq 350$ ns		$\Delta\tau \leq 450$ ns	
Temperature stability	≤ 2 kHz / K			
Connector	1 5/8" SMS unflanged		1 5/8" EIA	
Dimensions (L x W x H) mm	463 x 300 x 277		480 x 300 x 277	
Weight	≈ 20 kg			
Environmental conditions	For limitations see „Environmental Conditions for Broadcast Products“.			

1.3 kW - 1.6 kW UHF DTV Bandpass Filters

- Mask filters for ATV and DTV
- For 6, 7 and 8 MHz channel bandwidth
- With cross coupling (notch function)
- Tuneable within whole UHF range
- Temperature compensated
- DC block
- Installation horizontally or vertically
- Low profile design



Bandpass Filters

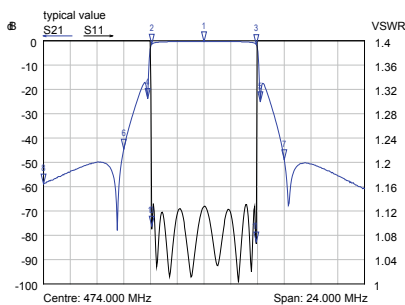

Typical diagram AS8112

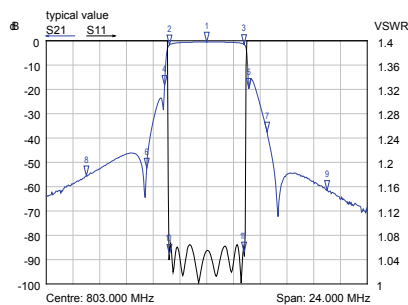

Typical diagram AS8117

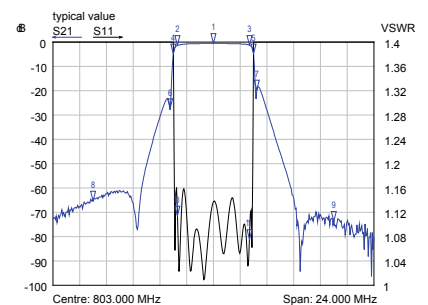

Typical diagram AS8115

Part Number	BN 616664C1031		BN 616664C1033						
Frequency range	470 - 860 MHz								
Number/size of cavities	8/120								
Harmonics attenuation	≥ 50 dB for f ≤ 1100 MHz								
TV standard	DVB-T @ 8 MHz ($\dot{U}/U_{rms} = 13$ dB)		ISDB-T @ 6 MHz ($\dot{U}/U_{rms} = 13$ dB)	ATSC 1.0 @ 6 MHz ($\dot{U}/U_{rms} = 11$ dB)					
Average input power	≤ 1.6 kW		≤ 1.3 kW	≤ 1.3 kW					
Tuning instruction	AS8112		AS8117	AS8115					
Insertion loss & mask filtering (alternative tuning on request)	470 MHz	860 MHz	470 MHz	803 MHz	470 MHz	803 MHz			
	f_0	≤ 0.4 dB	≤ 0.5 dB	f_0	≤ 0.45 dB	≤ 0.6 dB	f_0	≤ 0.5 dB	≤ 0.6 dB
	$f_0 \pm 3.805$	≤ 1.4 dB	≤ 1.9 dB	$f_0 \pm 2.79$	≤ 1.20 dB	≤ 1.7 dB	$f_0 \pm 2.69$	≤ 1.2 dB	≤ 1.5 dB
	$f_0 \pm 3.885$	≤ 1.5 dB	≤ 2.3 dB	$f_0 \pm 3.15$	≥ 15 dB		$f_0 \pm 3.00$	≥ 4 dB	
	$f_0 \pm 4.2$	≥ 15 dB		$f_0 \pm 4.5$	≥ 30 dB		$f_0 \pm 3.25$	≥ 18 dB	
	$f_0 \pm 6.0$	≥ 40 dB		$f_0 \pm 9.0$	≥ 55 dB		$f_0 \pm 9.0$	≥ 64 dB	
	$f_0 \pm 12.0$	≥ 55 dB							
VSWR (passband range)	≤ 1.15		≤ 1.09	≤ 1.15					
Group delay variation	$\Delta\tau \leq 700$ ns		$\Delta\tau \leq 600$ ns	$\Delta\tau \leq 400$ ns					
Temperature stability	≤ 2 kHz / K								
Connector	1 5/8" SMS unflanged		1 5/8" EIA						
Dimensions (L x W x H) mm	584 x 300 x 277		600 x 300 x 277						
Weight	≈ 22 kg								
Environmental conditions	For limitations see „Environmental Conditions for Broadcast Products“.								

2.25 kW UHF DTV Bandpass Filter

- Mask filters for ATSC
- For 6, 7 and 8 MHz channel bandwidth
- Without cross coupling
- Tuneable within whole UHF range
- Temperature compensated
- DC block
- Installation horizontally or vertically

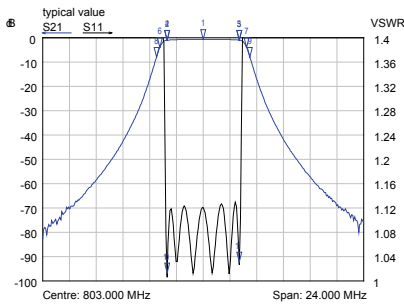

Typical diagram AS6081

Part Number	BN 616572	
Frequency range	470 - 810 MHz	
Number/size of cavities	6/150	
Harmonics attenuation	≥ 50 dB for f ≤ 860 MHz	
TV standard	ATSC 1.0 @ 6 MHz ($\dot{U}/U_{rms} = 11$ dB)	
Average input power	≤ 2.25 kW	
Tuning instruction	AS6081	
Insertion loss & mask filtering (alternative tuning on request)	470 MHz	803 MHz
	f_0	≤ 0.55 dB ≤ 0.75 dB
	$f_0 \pm 2.69$	≤ 0.80 dB ≤ 1.00 dB
	$f_0 \pm 3.00$	≤ 2.00 dB ≤ 2.30 dB
	$f_0 \pm 3.25$	≥ 3 dB
	$f_0 \pm 3.50$	≥ 8 dB
	$f_0 \pm 4.00$	≥ 15 dB
	$f_0 \pm 6.00$	≥ 40 dB
	$f_0 \pm 9.00$	≥ 65 dB
VSWR (passband range)	≤ 1.15	
Group delay variation	$\Delta\tau \leq 200$ ns	
Temperature stability	≤ 2 kHz / K	
Connectors	1 5/8" EIA male	
Dimensions (L x W x H) mm	528 x 326 x 411	
Weight	≈ 29 kg	
Environmental conditions	For limitations see „Environmental Conditions for Broadcast Products“.	

2.0 kW - 2.5 kW UHF DTV Bandpass Filters

- Mask filter for ATV and DTV
- For 6, 7 and 8 MHz channel bandwidth
- With cross coupling (notch function)
- Tuneable within whole UHF range
- Temperature compensated
- DC block
- Installation horizontally or vertically

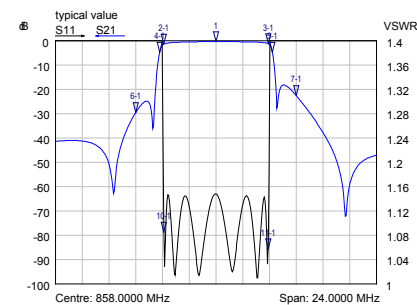

Typical diagram AS6193

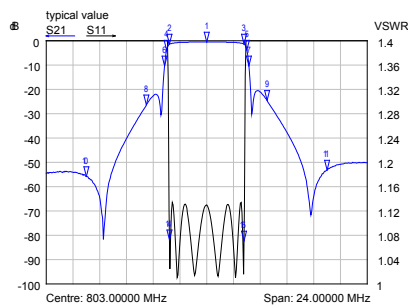

Typical diagram AS6184

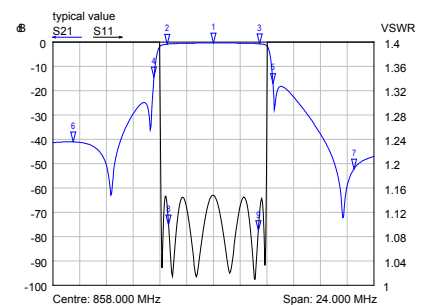

Typical diagram AS6289

Bandpass Filters

Part Number	BN 616518C1033		BN 616518C1031	
Frequency range	470 - 860 MHz			
Number/size of cavities	6/150			
Harmonics attenuation	≥ 50 dB for f ≤ 860 MHz			
TV standard	DVB-T @ 8 MHz ($\dot{U}/U_{rms} = 13$ dB)		ISDB-T @ 6 MHz ($\dot{U}/U_{rms} = 13$ dB)	
Average input power	≤ 2.5 kW		≤ 2 kW	
Tuning instruction	AS6193		AS6184	
Insertion loss & mask filtering (alternative tuning on request)	470 MHz 860 MHz		470 MHz 803 MHz	
	f_0	≤ 0.30 dB ≤ 0.45 dB	f_0	≤ 0.4 dB ≤ 0.6 dB
	$f_0 \pm 3.805$	≤ 0.75 dB ≤ 1.20 dB	$f_0 \pm 2.79$	≤ 1.1 dB ≤ 1.5 dB
	$f_0 \pm 3.885$	≤ 0.95 dB ≤ 1.40 dB	$f_0 \pm 3.00$	≥ 3.5 dB
	$f_0 \pm 4.2$	≥ 4 dB	$f_0 \pm 3.15$	≥ 8.0 dB
	$f_0 \pm 6.0$	≥ 20 dB	$f_0 \pm 4.5$	≥ 23 dB
	$f_0 \pm 12.0$	≥ 40 dB	$f_0 \pm 9.0$	≥ 48 dB
			$f_0 \pm 15.0$	≥ 50 dB
VSWR (passband range)	≤ 1.15		≤ 1.15	
Group delay variation	$\Delta\tau \leq 350$ ns		$\Delta\tau \leq 500$ ns	
Temperature stability	≤ 2 kHz / K			
Connectors	1 5/8" EIA		1 5/8" SMS unflanged	
Dimensions (L x W x H) mm	497 x 326 x 411			
Weight	≈ 28 kg			
Environmental conditions	For limitations see „Environmental Conditions for Broadcast Products“.			

1.6 kW - 2.0 kW UHF DTV Bandpass Filters

- Mask filters for ATV and DTV
- For 6, 7 and 8 MHz channel bandwidth
- With cross coupling (notch function)
- Tuneable within whole UHF range
- Temperature compensated
- DC block
- Installation horizontally or vertically

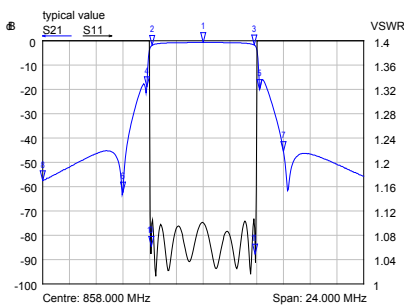

Typical diagram AS8071

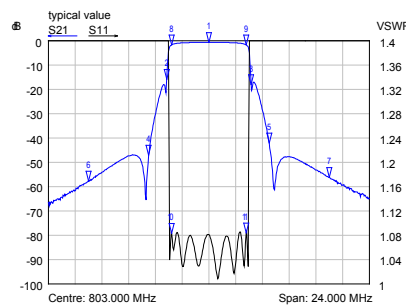

Typical diagram AS8096

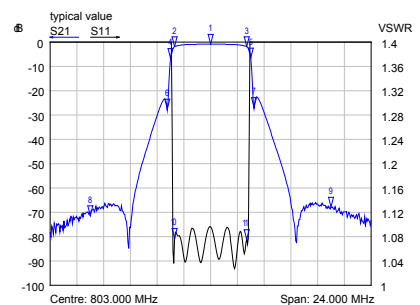

Typical diagram AS8094

Part Number Connector	BN 616542C1033 1 5/8" EIA		BN 616542C1031 1 5/8" Unflanged	
	Frequency range	470 - 860 MHz		
Number/size of cavities	8/150			
Harmonics attenuation	≥ 50 dB for f ≤ 860 MHz			
TV standard	DVB-T @ 8 MHz ($\dot{U}/U_{rms} = 13$ dB)	ISDB-T @ 6 MHz ($\dot{U}/U_{rms} = 13$ dB)	ATSC 1.0 @ 6 MHz ($\dot{U}/U_{rms} = 11$ dB)	
Average input power	≤ 2 kW	≤ 1.6 kW	≤ 1.6 kW	
Tuning instruction	AS8071	AS8096	AS8094	
Insertion loss & mask filtering (alternative tuning on request)	470 MHz 860 MHz	470 MHz 803 MHz	470 MHz 803 MHz	
	f_0 ≤ 0.4 dB ≤ 0.65 dB	f_0 ≤ 0.50 dB ≤ 0.70 dB	f_0 ≤ 0.70 dB ≤ 0.90 dB	
	$f_0 \pm 3.805$ ≤ 1.5 dB ≤ 2.10 dB	$f_0 \pm 2.79$ ≤ 1.30 dB ≤ 1.75 dB	$f_0 \pm 2.69$ ≤ 1.50 dB ≤ 1.60 dB	
	$f_0 \pm 3.885$ ≤ 1.7 dB ≤ 2.40 dB	$f_0 \pm 3.15$ ≥ 15 dB	$f_0 \pm 3.00$ ≥ 4 dB	
	$f_0 \pm 4.2$ ≥ 15 dB	$f_0 \pm 4.5$ ≥ 30 dB	$f_0 \pm 3.25$ ≥ 18 dB	
	$f_0 \pm 6.0$ ≥ 40 dB	$f_0 \pm 9.0$ ≥ 55 dB	$f_0 \pm 9.0$ ≥ 64 dB	
	$f_0 \pm 12.0$ ≥ 55 dB			
VSWR (passband range)	≤ 1.15	≤ 1.11	≤ 1.10	
Group delay variation	$\Delta\tau \leq 700$ ns	$\Delta\tau \leq 500$ ns	$\Delta\tau \leq 400$ ns	
Temperature stability	≤ 2 kHz / K			
Dimensions (L x W x H) mm	675 x 326 x 411			
Weight	≈ 36 kg			
Environmental conditions	For limitations see „Environmental Conditions for Broadcast Products“.			

3 kW - 6 kW UHF DTV Bandpass Filters

- Mask filters for ATSC
- For 6 channel bandwidth
- With cross coupling (notch function)
- Tuneable within the whole UHF range
- Temperature compensated
- DC block
- Installation horizontally or vertically
- Natural, fan or liquid cooling

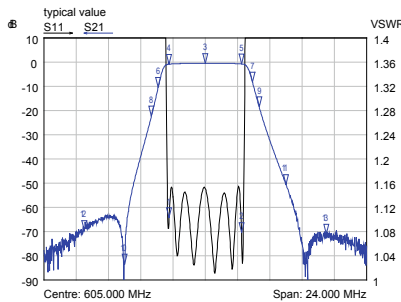

Typical diagram AS6585

Part Number Connector	BN 616577C1031 1 5/8" SMS Unflanged BN 616577C1033 1 5/8" EIA	BN 616577C2031 1 5/8" SMS Unflanged BN 616577C2033 1 5/8" EIA	BN 616577C4031 1 5/8" SMS Unflanged BN 616577C4033 1 5/8" EIA
Cooling	Natural Cooling	Liquid Cooling	Fan Cooling
Frequency range	470 - 700 MHz		
Number/size of cavities	6/171		
Harmonics attenuation	≥ 67 dB for f ≤ 800 MHz		
Mask filtering	ATSC 1.0 @ 6 MHz ($\dot{U}/U_{rms} = 11$ dB)	ATSC 3.0 @ 6 MHz ($\dot{U}/U_{rms} = 13$ dB)	
Average input power	≤ 3.0 kW natural cooling ≤ 6.0 kW forced cooling		
Tuning instruction	AS6585		
Insertion loss & mask filtering (alternative tuning on request)	470 MHz 700 MHz f_0 ≤ 0.40 dB ≤ 0.50 dB $f_0 \pm 2.69$ ≤ 0.60 dB ≤ 0.65 dB $f_0 \pm 2.92$ ≤ 0.75 dB ≤ 0.85 dB $f_0 \pm 3.50$ ≥ 3 dB $f_0 \pm 4.0$ ≥ 8 dB $f_0 \pm 6.0$ ≥ 30 dB $f_0 \pm 9.0$ ≥ 65 dB		
VSWR (passband range)	≤ 1.15		
Group delay variation	$\Delta\tau \leq 200$ ns		
Temperature stability	≤ 2 kHz / K		
Dimensions (L x W x H) mm	≈ 559 x 352 x 330		
Weight	≈ 29 kg		
Coolant/flow rate	–	Mix: glycol and water BN 154567 / ≥ 3 l/min	Air
Temperature of the coolant	–	10 °C - 55 °C	
Cooling interface	–	Stainless steel tube 12 x 1 mm unflanged ending straight at connector side (on request: ending straight or upwards at rear side)	Power supply for fans: 24 V DC Typ. 17 W Connector AMP 1-480703-0
Cooling accessories	–	See "Accessories for Fan- and Liquid-Cooled Filters".	
Environmental conditions	For limitations see „Environmental Conditions for Broadcast Products“.		

Bandpass
Filters

3 kW - 7.5 kW UHF DTV Bandpass Filters

- Mask filters for DTV and ATV
- For 6, 7 and 8 MHz channel bandwidth
- With cross coupling (notch function)
- Tuneable within the whole UHF range
- Temperature compensated
- DC block
- Installation horizontally or vertically
- Low profile design
- Natural, fan or liquid cooling

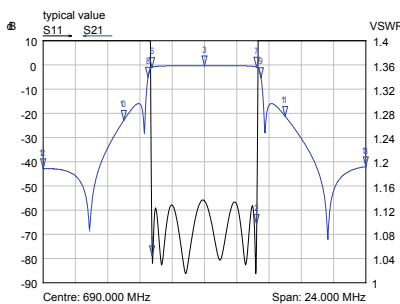

Typical diagram AS6548

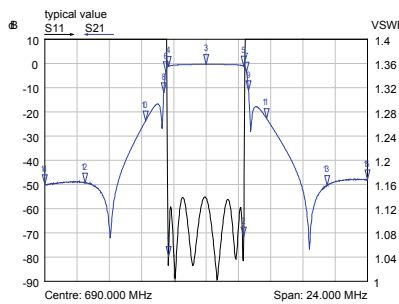

Typical diagram AS6549

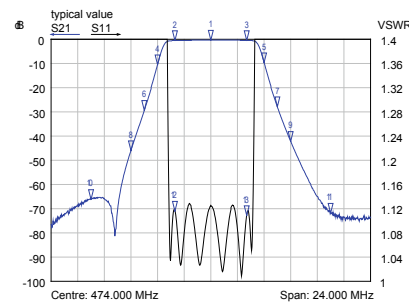

Typical diagram AS6550

Part Number	BN 616576C1031	BN 616576C2031	BN 616576C4031
Connector	1 5/8" SMS Unflanged BN 616576C1033 1 5/8" EIA	1 5/8" SMS Unflanged BN 616576C2033 1 5/8" EIA BN 616576C2041 3 1/8" SMS Unflanged BN 616576C2043 3 1/8" EIA	1 5/8" SMS Unflanged BN 616576C4033 1 5/8" EIA BN 616576C4041 3 1/8" SMS Unflanged BN 616576C4043 3 1/8" EIA
Cooling	Natural Cooling	Liquid Cooling	Fan Cooling
Frequency range	470 - 700 MHz		
Number/size of cavities	6/171		
Harmonics attenuation	≥ 50 dB for f ≤ 1000 MHz		
Mask filtering	DVB-T @ 8 MHz ($\dot{U}/U_{rms} = 13$ dB)		ISDB-T @ 6 MHz ($\dot{U}/U_{rms} = 13$ dB)
Average input power	≤ 3.75 kW natural cooling ≤ 7.0 kW forced cooling 1 5/8" ≤ 7.5 kW forced cooling 3 1/8"		≤ 3.0 kW natural cooling ≤ 6.0 kW forced cooling
Tuning instruction	AS6548		AS6549
Insertion loss & mask filtering (alternative tuning on request)	470 MHz 700 MHz		470 MHz 700 MHz
	f_0 ≤ 0.25 dB ≤ 0.35 dB	f_0 ≤ 0.40 dB ≤ 0.50 dB	
	$f_0 \pm 3.805$ ≤ 0.75 dB ≤ 0.90 dB	$f_0 \pm 2.79$ ≤ 1.05 dB ≤ 1.25 dB	
	$f_0 \pm 3.885$ ≤ 0.90 dB ≤ 1.00 dB	$f_0 \pm 3.00$ ≥ 3 dB	
	$f_0 \pm 4.2$ ≥ 4 dB	$f_0 \pm 3.15$ ≥ 5 dB	
	$f_0 \pm 6.0$ ≥ 20 dB	$f_0 \pm 4.5$ ≥ 17 dB	
	$f_0 \pm 12.0$ ≥ 40 dB	$f_0 \pm 9.0$ ≥ 38 dB	
		$f_0 \pm 15.0$ ≥ 48 dB	
VSWR (passband range)	≤ 1.15		≤ 1.15
Group delay variation	$\Delta\tau$ ≤ 350 ns		$\Delta\tau$ ≤ 400 ns
Temperature stability	≤ 2 kHz / K		
Dimensions (L x W x H) mm	≈ 559 x 352 x 330		
Weight	≈ 29 kg		
Coolant/flow rate	–	Mix: glycol and water BN 154567 / ≥ 3 l/min	Air
Temperature of the coolant	–	10 °C - 55 °C	
Cooling interface	–	Stainless steel tube 12 x 1 mm unflanged ending straight at connector side (on request: ending straight or upwards at rear side)	Power supply for fans: 24 V DC Typ. 17 W Connector AMP 1-480703-0
Cooling accessories	–	See "Accessories for Fan- and Liquid-Cooled Filters".	
Environmental conditions	For limitations see „Environmental Conditions for Broadcast Products“.		

3 kW - 6.25 kW UHF DTV Bandpass Filters

- Mask filters for DTV and ATV
- For 6, 7 and 8 MHz channel bandwidth
- With cross coupling (notch function)
- Tuneable within the whole UHF range
- Temperature compensated
- DC block
- Installation horizontally or vertically
- Low profile design
- Natural, fan or liquid cooling



Bandpass Filters

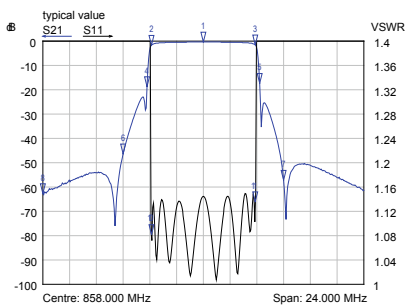

Typical diagram AS8182

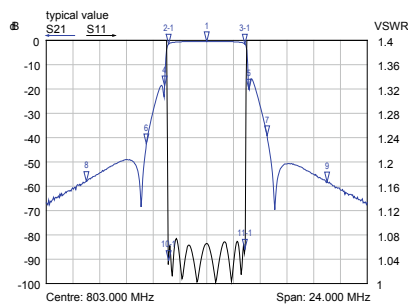

Typical diagram AS8183

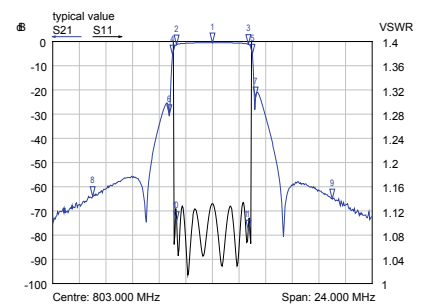

Typical diagram AS8184

Part Number	BN 616578C1031	BN 616578C2031	BN 616578C4031
Connector	1 5/8" SMS Unflanged BN 616578C1033 1 5/8" EIA	1 5/8" SMS Unflanged BN 616578C2033 1 5/8" EIA BN 616578C2041 3 1/8" SMS Unflanged BN 616578C2043 3 1/8" EIA	1 5/8" SMS Unflanged BN 616578C4033 1 5/8" EIA BN 616578C4041 3 1/8" SMS Unflanged BN 616578C4043 3 1/8" EIA
Cooling	Natural Cooling	Liquid Cooling	Fan Cooling
Frequency range	470 - 700 MHz		
Number/size of cavities	8/171		
Harmonics attenuation	≥ 50 dB for f ≤ 1000 MHz		
Mask filtering	DVB-T @ 8 MHz (Û/U _{rms} = 13 dB)	ISDB-T @ 6 MHz (Û/U _{rms} = 13 dB)	ATSC 1.0 @ 6 MHz (Û/U _{rms} = 11 dB)
Average input power	≤ 3.0 kW natural cooling ≤ 6.25 kW forced cooling	≤ 2.4 kW natural cooling ≤ 5.0 kW forced cooling	≤ 2.4 kW natural cooling ≤ 5.0 kW forced cooling
Tuning instruction	AS8182	AS8183	AS8184
Insertion loss & mask filtering (alternative tuning on request)	470 MHz 700 MHz f ₀ ≤ 0.35 dB ≤ 0.45 dB f ₀ ± 3.805 ≤ 1.10 dB ≤ 1.80 dB f ₀ ± 3.885 ≤ 1.40 dB ≤ 2.00 dB f ₀ ± 4.2 ≥ 15 dB f ₀ ± 6.0 ≥ 40 dB f ₀ ± 12.0 ≥ 55 dB	470 MHz 700 MHz f ₀ ≤ 0.4 dB ≤ 0.50 dB f ₀ ± 2.79 ≤ 1.3 dB ≤ 1.70 dB f ₀ ± 3.15 ≥ 12 dB f ₀ ± 4.5 ≥ 28 dB f ₀ ± 9.0 ≥ 54 dB	470 MHz 700 MHz f ₀ ≤ 0.45 dB ≤ 0.55 dB f ₀ ± 2.69 ≤ 1.05 dB ≤ 1.40 dB f ₀ ± 3.00 ≥ 4 dB f ₀ ± 3.25 ≥ 18 dB f ₀ ± 9.00 ≥ 64 dB
VSWR (passband range)	≤ 1.15	≤ 1.15	≤ 1.15
Group delay variation	Δτ ≤ 700 ns	Δτ ≤ 650 ns	Δτ ≤ 500 ns
Temperature stability	≤ 2 kHz / K		
Dimensions (L x W x H) mm	≈ 730 x 352 x 330		
Weight	≈ 38 kg		
Coolant/flow rate	–	Mix: glycol and water BN 154567 / ≥ 3 l/min	Air
Temperature of the coolant	–	10 °C - 55 °C	–
Cooling interface	–	Stainless steele tube 12 x 1 mm unflanged ending straight at connector side (on request: ending straight or upwards at rear side)	Power supply for fans: 24 V DC Typ. 25 W Connector AMP 1-480703-0
Cooling accessories	–	See "Accessories for Fan- and Liquid-Cooled Filters".	
Environmental conditions	For limitations see „Environmental Conditions for Broadcast Products“.		

6 kW - 21 kW UHF ATV Bandpass Filters

- Mask filters for ATV
- For 6, 7 and 8 MHz channel bandwidth
- With cross coupling (notch function)
- Tuneable within the whole UHF range
- Temperature compensated
- Installation horizontally or vertically
- DC block
- Natural or liquid cooling

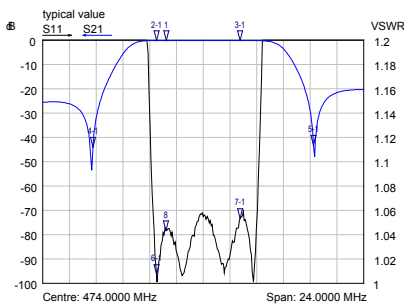

Typical diagram AS4009

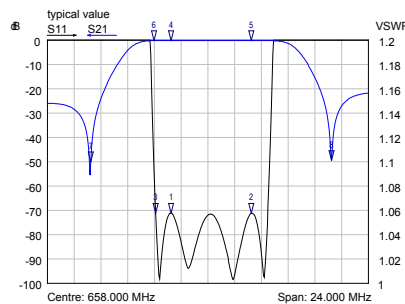

Typical diagram AS4018

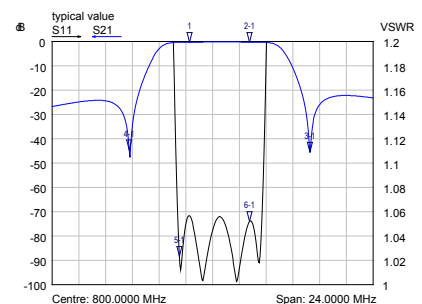

Typical diagram AS4033

Part Number Connector Cooling	BN 616409 3 1/8" SMS Unflanged BN 616409C0002 3 1/8" EIA		BN 616409C0020 3 1/8" SMS Unflanged BN 616409C0022 3 1/8" EIA	
	Natural Cooling		Liquid Cooling	
Frequency range	470 - 860 MHz			
Number/size of cavities	4/200			
Harmonics attenuation	≥ 40 dB for f ≤ 800 MHz			
Mask filtering	ATV 8 MHz		ATV 8 MHz	
Average input power The input power of liquid cooled filters must be reduced if installed more than 500 m above sea level.	≤ 7.5 kW natural cooling ≤ 21 kW @ 0 - 500 m liquid cooling ≤ 18 kW @ 1600 m ≤ 15 kW @ 2600 m ≤ 12 kW @ 3800 m		≤ 7.5 kW natural cooling ≤ 21 kW @ 0 - 500 m liquid cooling ≤ 18 kW @ 1600 m ≤ 15 kW @ 2600 m ≤ 12 kW @ 3800 m	
Tuning instruction	Standard G: AS4009		Standard I: AS4018 Standard K: AS4014	
Insertion loss & mask filtering (alternative tuning on request)	470 MHz	860 MHz	470 MHz	860 MHz
$f_{(V)} - \Delta$	> 40.0 dB	> 40.0 dB	> 40.0 dB	> 40.0 dB
$f_{(V)} - 0.75 \text{ MHz}$	≤ 0.15 dB	≤ 0.20 dB	≤ 0.20 dB	≤ 0.20 dB
$f_{(V)}$	≤ 0.15 dB	≤ 0.20 dB	≤ 0.20 dB	≤ 0.20 dB
$f_{(S)} = f_{(V)} + \Delta$	≤ 0.15 dB	≤ 0.20 dB	≤ 0.20 dB	≤ 0.20 dB
$f_{(V)} + 2\Delta$	> 40.0 dB	> 40.0 dB	> 40.0 dB	> 40.0 dB
VSWR (passband range)			$f_{(V)} - 0.75 \text{ MHz}$	≤ 1.06
			$f_{(V)}$	≤ 1.06
			$f_{(S)} = f_{(V)} + \Delta$	≤ 1.06
Group delay variation	$\Delta\tau \leq 50 \text{ ns}$			
Temperature stability	≤ 2 kHz / K			
Dimensions (L x W x H) mm	463 x 450 x 442 487 x 450 x 442	BN 616409 BN 616409C0002	463 x 450 x 442 487 x 450 x 442	BN 616409C0020 BN 616409C0022
Weight	≈ 35 kg		≈ 35 kg	
Coolant/flow rate	-		Mix: glycol and water BN 154567 / ≥ 3 l/min	
Temperature of the coolant	-		20 °C - 60 °C	
Cooling interface	-		Ending horizontally at rear side	
Material of cooling	-		Stainless steel pipe	
Environmental conditions	For limitations see „Environmental Conditions for Broadcast Products“.			

4.5 kW - 10 kW UHF DTV Bandpass Filters

- Mask filters for ATSC
- For 6 MHz channel bandwidth
- Without cross coupling
- Tuneable within the whole UHF range
- Temperature compensated
- Installation horizontally or vertically
- DC block
- Natural, fan or liquid cooling

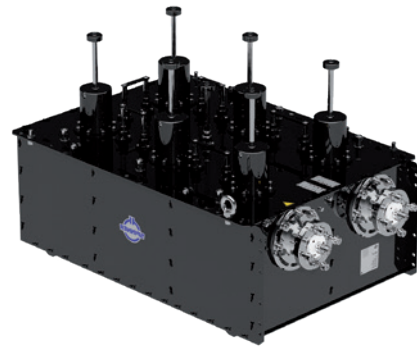

Bandpass Filters

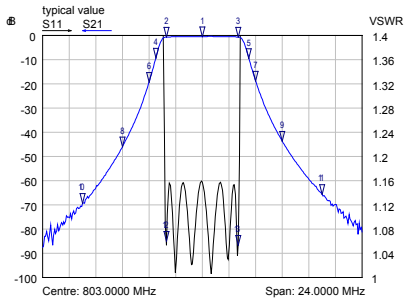

Typical diagram AS6082

Part Number Connector	BN 616571C1033 1 5/8" EIA	BN 616571C2041 3 1/8" SMS Unflanged BN 616571C2043 3 1/8" EIA	BN 616571C4041 3 1/8" SMS Unflanged BN 616571C4043 3 1/8" EIA
Cooling	Natural Cooling	Liquid Cooling	Fan Cooling
Frequency range		470 - 810 MHz	
Number/size of cavities	6/200		
Harmonics attenuation	≥ 50 dB for f ≤ 860 MHz		
Mask filtering	ATSC 1.0 @ 6 MHz (Ü/U _{rms} =11 dB)		
Average input power The input power of liquid cooled filters must be reduced if installed more than 500 m above sea level.	≤ 4.5 kW natural cooling	≤ 10 kW @ 0 - 600 m forced cooling ≤ 8 kW @ 2000 m ≤ 6 kW @ 3400 m	
Tuning instruction	AS6082		
Insertion loss & mask filtering (alternative tuning on request)		473 MHz 803 MHz	
		f ₀ ≤ 0.4 dB ≤ 0.60 dB	
		f ₀ ± 2.69 ≤ 0.6 dB ≤ 0.80 dB	
		f ₀ ± 3.00 ≤ 1.5 dB ≤ 1.75 dB	
		f ₀ ± 4.00 ≥ 15 dB	
		f ₀ ± 6.00 ≥ 40 dB	
		f ₀ ± 9.00 ≥ 65 dB	
VSWR (passband range)	≤ 1.15		
Group delay variation	Δτ ≤ 100 ns		
Temperature stability	≤ 2 kHz / K		
Dimensions (L x W x H) mm	≈ 777 x 450 x 450		
Weight	≈ 48 kg		
Coolant/flow rate	-	Mix: glycol and water BN 154567 / ≥ 3 l/min	Air
Temperature of the coolant	-	20 °C - 60 °C	-
Cooling interface	-	Stainless steel tube 12 x1 mm unflanged ending straight at the rear side	Power supply for fans: 24 V DC / typ. 17 W Connector AMP 1-480703-0
Cooling accessories	See "Accessories for Fan- and Liquid-Cooled Filters".		
Environmental conditions	For limitations see „Environmental Conditions for Broadcast Products“.		

4 kW - 12.5 kW UHF DTV Bandpass Filters

- Mask filters for DTV and ATV
- For 6, 7 and 8 MHz channel bandwidth
- With cross coupling (notch function)
- Tuneable within the whole UHF range
- Temperature compensated
- Installation horizontally or vertically
- DC block
- Natural, fan or liquid cooling

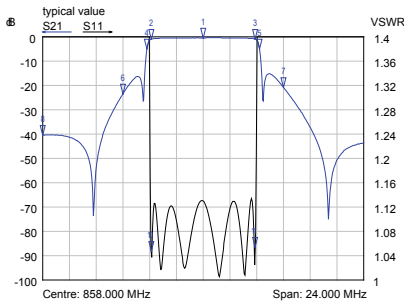

Typical diagram AS6194

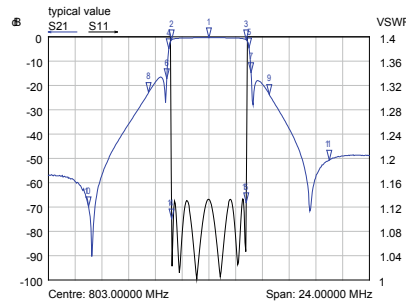

Typical diagram AS6185

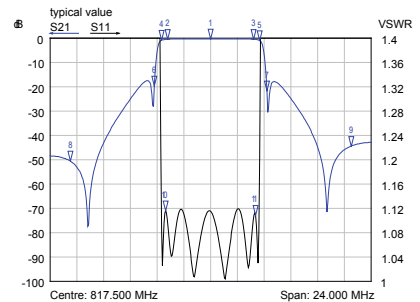

Typical diagram AS6290

Part Number Connector	BN 616540C1031 1 5/8" SMS Unflanged BN 616540C1033 1 5/8" EIA	BN 616540C2033 1 5/8" EIA BN 616540C2041 3 1/8" SMS Unflanged BN 616540C2043 3 1/8" EIA	BN 616540C4033 1 5/8" EIA BN 616540C4041 3 1/8" SMS Unflanged BN 616540C4043 3 1/8" EIA
Cooling	Natural Cooling	Liquid Cooling	Fan Cooling
Frequency range	470 - 860 MHz		
Number/size of cavities	6/200		
Harmonics attenuation	≥ 50 dB for f ≤ 860 MHz		
Mask filtering	DVB-T @ 8 MHz ($\dot{U}/U_{rms} = 13$ dB)	ISDB-T @ 6 MHz ($\dot{U}/U_{rms} = 13$ dB)	DVB-T @ 7 MHz ($\dot{U}/U_{rms} = 13$ dB)
Average input power The input power of liquid cooled filters must be reduced if installed more than 500 m above sea level.	≤ 5 kW natural cooling ≤ 7 kW forced cooling 1 5/8" input forced cooling 3 1/8" input ≤ 12.5 kW @ 0 - 500 m ≤ 10 kW @ 2000 m ≤ 8 kW @ 3200 m	≤ 4 kW natural cooling ≤ 7 kW forced cooling 1 5/8" input forced cooling 3 1/8" input ≤ 10 kW @ 0 - 500 m ≤ 8 kW @ 2000 m ≤ 6 kW @ 3400 m	≤ 4.5 kW natural cooling ≤ 7 kW forced cooling 1 5/8" input forced cooling 3 1/8" input ≤ 10 kW @ 0 - 500 m ≤ 8 kW @ 2000 m ≤ 6 kW @ 3400 m
Tuning instruction	AS6194 470 MHz 860 MHz	AS6185 470 MHz 803 MHz	AS6290 470 MHz 820 MHz
Insertion loss & mask filtering (alternative tuning on request)	f_0 ≤ 0.20 dB ≤ 0.35 dB $f_0 \pm 3.805$ ≤ 0.60 dB ≤ 0.90 dB $f_0 \pm 3.885$ ≤ 0.75 dB ≤ 1.05 dB $f_0 \pm 4.2$ ≥ 4 dB $f_0 \pm 6.0$ ≥ 20 dB $f_0 \pm 12.0$ ≥ 40 dB	f_0 ≤ 0.3 dB ≤ 0.45 dB $f_0 \pm 2.79$ ≤ 0.9 dB ≤ 1.30 dB $f_0 \pm 3.00$ ≥ 4 dB $f_0 \pm 3.15$ ≥ 8 dB $f_0 \pm 4.5$ ≥ 23 dB $f_0 \pm 9.0$ ≥ 48 dB $f_0 \pm 15.0$ ≥ 50 dB	f_0 ≤ 0.20 dB ≤ 0.30 dB $f_0 \pm 3.2$ ≤ 0.35 dB ≤ 0.45 dB $f_0 \pm 4.2$ ≥ 13 dB $f_0 \pm 10.5$ ≥ 38 dB
VSWR (passband range)	≤ 1.15	≤ 1.15	≤ 1.15
Group delay variation	$\Delta\tau \leq 350$ ns	$\Delta\tau \leq 500$ ns	$\Delta\tau \leq 150$ ns
Temperature stability	≤ 2 kHz / K		
Dimensions (L x W x H) mm	≈ 690 x 450 x 440		
Weight	≈ 47 kg	≈ 50 kg	≈ 56 kg
Coolant/flow rate	-	Mix: glycol and water BN 154567 / ≥ 3 l/min	Air
Temperature of the coolant	-	20 °C - 60 °C	-
Cooling interface	-	Stainless steel tube 12 x 1 mm unflanged ending straight at the connector side	Power supply for fans: 24 V DC / typ. 17W Connector AMP 1-480703-0
Cooling accessories	See "Accessories for Fan- and Liquid-Cooled Filters".		
Environmental conditions	For limitations see „Environmental Conditions for Broadcast Products“.		

3.2 kW - 12.5 kW UHF DTV Bandpass Filters

- Mask filters for DTV and ATV
- For 6, 7 and 8 MHz channel bandwidth
- With cross coupling (notch function)
- Tuneable within the whole UHF range
- Temperature compensated
- Installation horizontally or vertically
- DC block
- Natural, fan or liquid cooling



Bandpass Filters

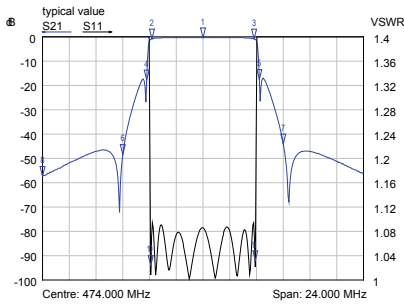

Typical diagram AS8067

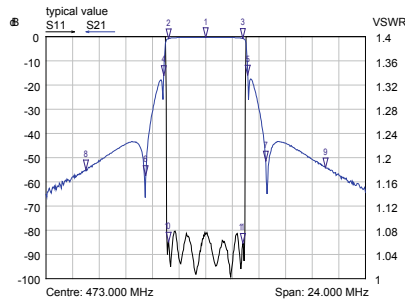

Typical diagram AS8074

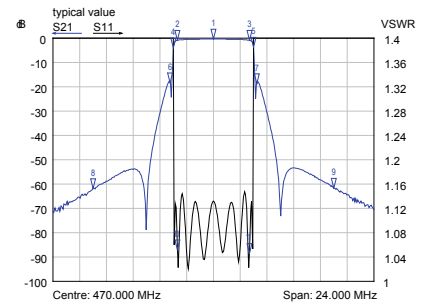

Typical diagram AS8066

Part Number Connector	BN 616544C1033 1 5/8" EIA		BN 616544C2033 1 5/8" EIA BN 616544C2041 3 1/8" SMS Unflanged BN 616544C2043 3 1/8" EIA		BN 616544C4033 1 5/8" EIA BN 616544C4041 3 1/8" SMS Unflanged BN 616544C4043 3 1/8" EIA	
Cooling	Natural Cooling		Liquid Cooling		Fan Cooling	
Frequency range	470 - 860 MHz					
Number/size of cavities	8/200					
Harmonics attenuation	≥ 50 dB for f ≤ 860 MHz					
Mask filtering	DVB-T @ 8 MHz ($\dot{U}/U_{rms} = 13$ dB)		ISDB-T @ 6 MHz ($\dot{U}/U_{rms} = 13$ dB)		ATSC 1.0 @ 6 MHz ($\dot{U}/U_{rms} = 11$ dB)	
Average input power The input power of forced cooled filters must be reduced if installed more than 500 m above sea level.	≤ 4 kW natural cooling ≤ 7 kW forced cooling 1 5/8" input forced cooling 3 1/8" input ≤ 12.5 kW @ 0 - 500 m ≤ 10 kW @ 2000 m ≤ 8 kW @ 3200 m		≤ 3.2 kW natural cooling ≤ 7 kW forced cooling 1 5/8" input forced cooling 3 1/8" input ≤ 10 kW @ 0 - 500 m ≤ 8 kW @ 2000 m ≤ 6 kW @ 3400 m		≤ 3.2 kW natural cooling ≤ 7 kW forced cooling 1 5/8" input forced cooling 3 1/8" input ≤ 10 kW @ 0 - 500 m ≤ 8 kW @ 2000 m ≤ 6 kW @ 3400 m	
Tuning instruction	AS8067 470 MHz 860 MHz		AS8074 470 MHz 803 MHz		AS8066 470 MHz 820 MHz	
Insertion loss & mask filtering (alternative tuning on request)	f_0 ≤ 0.3 dB ≤ 0.4 dB $f_0 \pm 3.805$ ≤ 0.9 dB ≤ 1.3 dB $f_0 \pm 3.885$ ≤ 1.4 dB ≤ 1.6 dB $f_0 \pm 4.2$ ≥ 15 dB $f_0 \pm 6.0$ ≥ 40 dB $f_0 \pm 12.0$ ≥ 55 dB		f_0 ≤ 0.35 dB ≤ 0.4 dB $f_0 \pm 2.79$ ≤ 1.10 dB ≤ 1.4 dB $f_0 \pm 3.15$ ≥ 15 dB $f_0 \pm 4.5$ ≥ 30 dB $f_0 \pm 9.0$ ≥ 55 dB		f_0 ≤ 0.4 dB ≤ 0.45 dB $f_0 \pm 2.69$ ≤ 0.9 dB ≤ 1.20 dB $f_0 \pm 3.00$ ≥ 4 dB $f_0 \pm 3.25$ ≥ 18 dB $f_0 \pm 9.00$ ≥ 64 dB	
VSWR (passband range)	≤ 1.10		≤ 1.09		≤ 1.10	
Group delay variation	$\Delta\tau \leq 700$ ns		$\Delta\tau \leq 500$ ns		$\Delta\tau \leq 400$ ns	
Temperature stability	≤ 2 kHz / K					
Dimensions (L x W x H) mm	≈ 893 x 450 x 440					
Weight	≈ 65 kg					
Coolant/flow rate	-		Mix: glycol and water BN 154567 / ≥ 3 l/min		Air	
Temperature of the coolant	-		20 °C - 60 °C		-	
Cooling interface	-		Stainless steel tube 12 x 1 mm unflanged ending straight at the rear side		Power supply for fans: 24 V DC / typ. 25 W Connector AMP 1-480703-0	
Cooling accessories	See "Accessories for Fan- and Liquid-Cooled Filters".					
Environmental conditions	For limitations see „Environmental Conditions for Broadcast Products“.					

6.75 kW - 18 kW UHF DTV Bandpass Filters

- Mask filters for DTV and ATV
- For 6, 7 and 8 MHz channel bandwidth
- With cross coupling (notch function)
- Tuneable within the whole UHF range
- Temperature compensated
- Installation horizontally or vertically
- DC block
- Natural, fan or liquid cooling

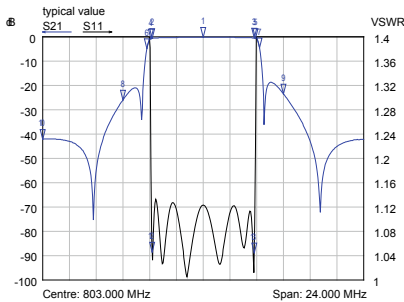
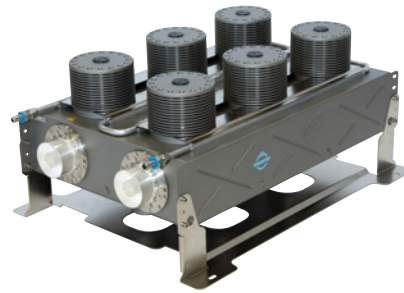

Typical diagram AS6303

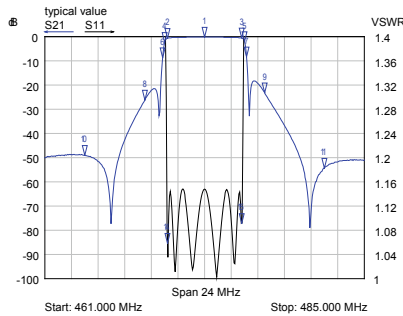

Typical diagram AS6365

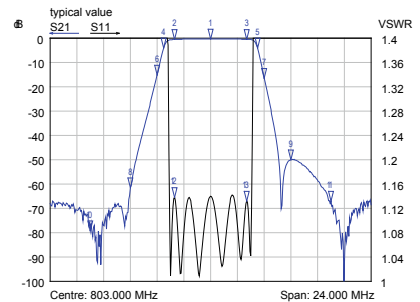

Typical diagram AS6308

Part Number Connector	BN 616669C1041 3 1/8" SMS unflanged BN 616669C1043 3 1/8" EIA	BN 616669C2041 3 1/8" SMS unflanged BN 616669C2043 3 1/8" EIA	BN 616669C4041 3 1/8" SMS unflanged BN 616669C4043 3 1/8" EIA
Cooling	Natural Cooling	Liquid Cooling	Fan Cooling
Frequency range		470 - 790 MHz	
Number/size of cavities	6/230		
Harmonics attenuation	≥ 50 dB for f ≤ 800 MHz		
Mask filtering	DVB-T @ 8 MHz ($\dot{U}/U_{rms} = 13$ dB)	ISDB-T @ 6 MHz ($\dot{U}/U_{rms} = 13$ dB)	ATSC 1.0 @ 6 MHz ($\dot{U}/U_{rms} = 11$ dB)
Average input power The input power of forced cooled filters must be reduced if installed more than 500 m above sea level.	≤ 8.5 kW natural cooling ≤ 18 kW @ 0 - 500 m forced cooling ≤ 16 kW @ 1400 m ≤ 14 kW @ 2200 m ≤ 12 kW @ 3000 m ≤ 10 kW @ 3800 m	≤ 6.75 kW natural cooling ≤ 15 kW @ 0 - 500 m forced cooling ≤ 14 kW @ 1400 m ≤ 12 kW @ 2200 m ≤ 10 kW @ 3000 m ≤ 8 kW @ 4000 m	≤ 6.75 kW natural cooling ≤ 18 kW @ 0 - 500 m forced cooling ≤ 16 kW @ 1400 m ≤ 14 kW @ 2200 m ≤ 12 kW @ 3000 m ≤ 10 kW @ 3800 m
Tuning instruction	AS6303	AS6365	AS6308
Insertion loss & mask filtering (alternative tuning on request)	470 MHz 790 MHz f_0 ≤ 0.20 dB ≤ 0.30 dB $f_0 \pm 3.805$ ≤ 0.65 dB ≤ 0.80 dB $f_0 \pm 3.885$ ≤ 0.75 dB ≤ 0.90 dB $f_0 \pm 4.20$ ≥ 4 dB $f_0 \pm 6.00$ ≥ 20 dB $f_0 \pm 12.0$ ≥ 40 dB	470 MHz 790 MHz f_0 ≤ 0.30 dB ≤ 0.35 dB $f_0 \pm 2.79$ ≤ 0.75 dB ≤ 0.90 dB $f_0 \pm 3.00$ ≥ 2 dB $f_0 \pm 3.15$ ≥ 8 dB $f_0 \pm 4.50$ ≥ 23 dB $f_0 \pm 9.00$ ≥ 48 dB $f_0 \pm 15.0$ ≥ 50 dB	470 MHz 790 MHz f_0 ≤ 0.35 dB ≤ 0.40 dB $f_0 \pm 2.69$ ≤ 0.70 dB ≤ 0.70 dB $f_0 \pm 3.50$ ≥ 3 dB $f_0 \pm 4.00$ ≥ 8 dB $f_0 \pm 6.00$ ≥ 30 dB $f_0 \pm 9.00$ ≥ 65 dB
VSWR (passband range)	≤ 1.15	≤ 1.15	≤ 1.15
Group delay variation	$\Delta\tau$ ≤ 350 ns	$\Delta\tau$ ≤ 500 ns	$\Delta\tau$ ≤ 200 ns
Temperature stability	≤ 2 kHz / K		
Dimensions (L x W x H) mm	≈ 804 x 570 x 352		
Weight	≈ 55 kg		
Coolant/flow rate	-	Mix: glycol and water BN 154567 / ≥ 3 l/min	Air
Temperature of the coolant	10 °C - 55 °C		-
Cooling interface	-	Stainless steel tube 12 x 1 mm unflanged ending straight at the connector side (on request: ending straight or ending upwards at rear side)	Power supply for fans: 24 V DC / typ. 17W Connector AMP 1-480703-0
Cooling accessories	See "Accessories for Fan- and Liquid-Cooled Filters".		
Environmental conditions	For limitations see „Environmental Conditions for Broadcast Products“.		

6.75 kW - 16.5 kW UHF DTV Bandpass Filters

- Mask filters for DTV and ATV
- For 6, 7 and 8 MHz channel bandwidth
- With cross coupling (notch function)
- Tuneable within the whole UHF range
- Temperature compensated
- Installation horizontally or vertically
- DC block
- Natural, fan or liquid cooling

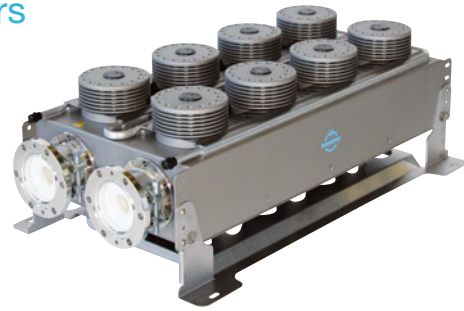

Bandpass Filters

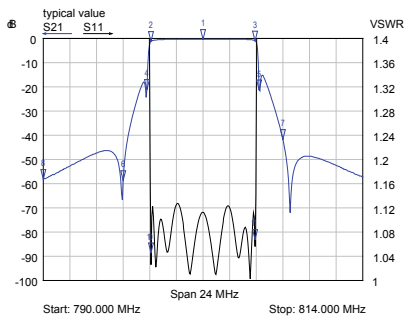

Typical diagram AS8124

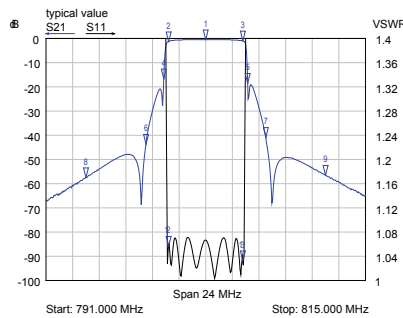

Typical diagram AS8128

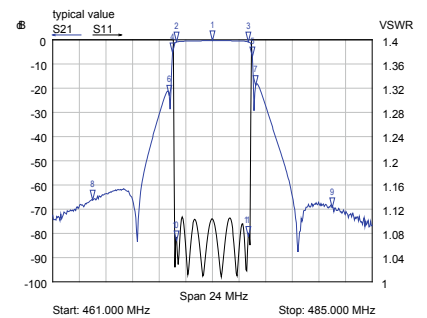

Typical diagram AS8127

Part Number Connector	BN 616670C1041 3 1/8" SMS unflanged BN 616670C1043 3 1/8" EIA	BN 616670C2041 3 1/8" SMS unflanged BN 616670C2043 3 1/8" EIA	BN 616670C4041 3 1/8" SMS unflanged BN 616670C4043 3 1/8" EIA
Cooling	Natural Cooling	Liquid Cooling	Fan Cooling
Frequency range	470 - 790 MHz		
Number/size of cavities	8/230		
Harmonics attenuation	≥ 50 dB for f ≤ 860 MHz		
Mask filtering	DVB-T @ 8 MHz ($\dot{U}/U_{rms} = 13$ dB)	ISDB-T @ 6 MHz ($\dot{U}/U_{rms} = 13$ dB)	ATSC 1.0 @ 6 MHz ($\dot{U}/U_{rms} = 11$ dB)
Average input power The input power of liquid cooled filters must be reduced if installed more than 500 m above sea level.	≤ 8.5 kW natural cooling ≤ 16.5 kW @ 0 - 500 m forced cooling ≤ 14 kW @ 1600 m ≤ 12 kW @ 2400 m ≤ 10 kW @ 3400 m ≤ 8 kW @ 4200 m	≤ 6.75 kW natural cooling ≤ 13.5 kW @ 0 - 500 m forced cooling ≤ 12 kW @ 1200 m ≤ 10 kW @ 2400 m ≤ 8 kW @ 3400 m ≤ 6 kW @ 4600 m	≤ 6.75 kW natural cooling ≤ 16.5 kW @ 0 - 500 m forced cooling ≤ 14 kW @ 1600 m ≤ 12 kW @ 2400 m ≤ 10 kW @ 3400 m ≤ 8 kW @ 4200 m
Tuning instruction	AS8124	AS8128	AS8127
Insertion loss & mask filtering (alternative tuning on request)	470 MHz 790 MHz f_0 ≤ 0.30 dB ≤ 0.30 dB $f_0 \pm 3.805$ ≤ 0.95 dB ≤ 1.00 dB $f_0 \pm 3.885$ ≤ 1.15 dB ≤ 1.25 dB $f_0 \pm 4.20$ ≥ 15 dB $f_0 \pm 6.00$ ≥ 40 dB $f_0 \pm 12.0$ ≥ 55 dB	470 MHz 790 MHz f_0 ≤ 0.35 dB ≤ 0.40 dB $f_0 \pm 2.79$ ≤ 1.05 dB ≤ 1.10 dB $f_0 \pm 3.15$ ≥ 15 dB $f_0 \pm 4.50$ ≥ 30 dB $f_0 \pm 9.00$ ≥ 55 dB $f_0 \pm 15.0$ ≥ 65 dB	470 MHz 790 MHz f_0 ≤ 0.35 dB ≤ 0.40 dB $f_0 \pm 2.69$ ≤ 0.90 dB ≤ 1.00 dB $f_0 \pm 3.00$ ≥ 4 dB $f_0 \pm 3.25$ ≥ 18 dB $f_0 \pm 9.00$ ≥ 64 dB
VSWR (passband range)	≤ 1.15	≤ 1.085	≤ 1.15
Group delay variation	$\Delta\tau \leq 700$ ns	$\Delta\tau \leq 550$ ns	$\Delta\tau \leq 450$ ns
Temperature stability	≤ 2 kHz / K		
Dimensions (L x W x H) mm	≈ 1030 x 570 x 352		
Weight	≈ 72 kg		
Coolant/flow rate	–	Mix: glycol and water BN 154567 / ≥ 3 l/min	Air
Temperature of the coolant	–	10 °C - 55 °C	–
Cooling interface	–	Stainless steel tube 12x1 mm unflanged ending straight at the connector side (on request: ending straight at rear side or ending upwards at rear side)	Power supply for fans: 24 V DC / typ. 25 W Connector AMP 1-480703-0
Cooling accessories	–	See "Accessories for Fan- and Liquid-Cooled Filters".	
Environmental conditions	For limitations see „Environmental Conditions for Broadcast Products“.		

1.2 kW - 2 kW Low-Pass Filters

- Low-pass filters for suppression of harmonics
- Compact design
- Low attenuation in passband



BN 616453



BN 616395



BN 616452C0011

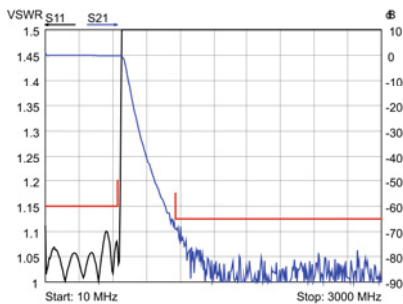

Typical diagram

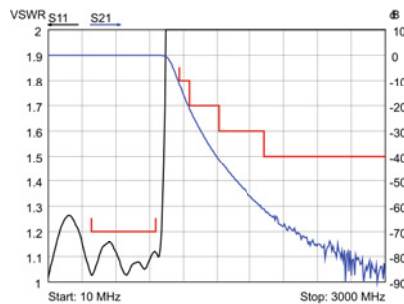

Typical diagram

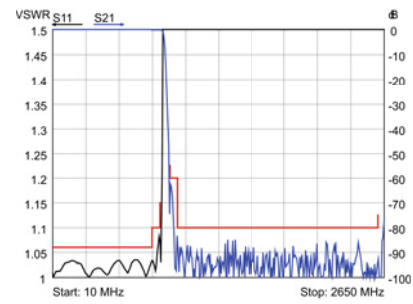

Typical diagram

Part Number	616453	BN 616395	BN 616452C0011
Passband	0 - 650 MHz	330 - 960 MHz	470 - 860 MHz
Average input power	200 W	≤ 1 kW	≤ 2 kW
Passband insertion loss	≤ 0.2 dB	390 - 960 MHz ≤ 0.1 dB	470 - 800 MHz ≤ 0.10 dB 800 - 860 MHz ≤ 0.18 dB
Stopband attenuation	1160MHz > 65 dB 1500MHz > 80 dB 3000MHz > 80 dB	1.170 GHz ≥ 10 dB 1.260 GHz ≥ 20 dB 1.520 GHz ≥ 30 dB 1.930 GHz ≥ 40 dB	0.94 - 1.0 GHz ≥ 60 dB 1.00 - 2.6 GHz ≥ 80 dB
VSWR (passband range)	1.15	≤ 1.2	470 - 800 MHz ≤ 1.06 800 - 860 MHz ≤ 1.10
Group delay variation	$\Delta\tau \leq 5$ ns	$\Delta\tau \leq 1$ ns	$\Delta\tau \leq 20$ ns
Proof voltage	1.5 kV	3.5 kV	470 - 800 MHz 3.5 kV 800 - 860 MHz 1.6 kV
Connectors	N-female / N-male	7-16 female / 7-16 male	7-16 female
Dimensions (L x W x H) mm	277 x 26,5 x 26,5	174 x 32 x 32	406 x 80 x 80
Weight	≈ 0.8 kg	≈ 0.6 kg	≈ 2.0 kg
Environmental conditions	For limitations see „Environmental Conditions for Broadcast Products“.		

Accessories for Fan- and Liquid-Cooled Filters

SPINNER supplies fan- and liquid-cooled filters and combiners for high transmitter power levels. Fan and liquid cooling are almost equally effective. However, it is simpler to install fan cooling systems because they only require DC wiring, whereas hoses and pumps are needed for liquid cooling systems.

Another difference is that fan cooling transfers the heat into the room, while liquid cooling can be used to carry the heat outdoors. Which cooling system is best in a given case depends on things like whether a liquid cooling system already exists, the capacity of an available air conditioning system, and redundancy requirements.

If forced cooling fails, operation can be continued with natural cooling at reduced power. SPINNER supplies all cooled filters and combiners with a temperature switch that shows whether the filter is too hot (85°C or more) making it necessary to reduce the power. The fans have to be powered with 24V DC from an existing source or via a SPINNER BN 155815 mains adapter, which has capacity for up to 10 filters. SPINNER has many options for implementing liquid-cooled filters, either to supplement existing cooling systems or for use as standalone combiner cooling systems with heat sinks:

- Various interfaces for cooling pipes
- Cooler unit with heat sinks



Pump unit and UHF combiner with liquid cooled filter



Pump unit and indoor cooler

Cutting Ring Fittings to Interface the Cooling Tube	Part Number
Tube fitting hose barb connector 1/2"	BN A72955
Tube fitting gauge connector 3/8" female straight	BN A74262
Tube fitting gauge connector 3/8" male straight	BN A74263
Tube fitting gauge connector 3/8" female 90° elbow	BN A74318
Tube fitting gauge connector 3/8" male 90° elbow	BN A74320
Tube fitting gauge connector 1/2" female straight	BN A74260
Tube fitting gauge connector 1/2" male straight	BN A74261
Tube fitting gauge connector 1/2" female 90° elbow	BN A74317
Tube fitting gauge connector 1/2" male 90° elbow	BN A74319
Coolant	
25l can with coolant (mix glycol and water and anti corrosive)	BN 154567
Cooler	
Cooling unit with reservoir, twin pump, water splitter, valves	BN 155729
Fan Cooling accessories	
Mains adapter	BN 155815
Spare fan	BN B22410
DC distribution cables	BN 155817
Temperature switches	
Normally closed contact opening at 71 °C (optional)	BN A72406
Normally closed contact opening at 85 °C (included)	BN B18100

Patch Panels



Patch panels are used to route transmitter signals to single, half or backup antennas or dummy loads or to bypass intermediate systems such as combiners or splitters.

Switching can be performed by motorized switches or manually with U-links. All patch panels have an interlock system that briefly switches off the transmitter during the switchover.

All input and output connectors terminate horizontally with an EIA flange system behind the front panel.

The systems connected to the patch panel can be easily, quickly and precisely measured with test adapters.

SPINNER supplies patch panels for all frequency ranges and sizes (7-16 to 6 1/8"). On request, patch panels can

also be equipped with 3dB couplers for use as power splitters or with measurement couplers.

Note:

With digital signal operation, the transmittable power is limited either by the proof voltage, (while taking the crest factor into account) or by the average power.

When operating multiple transmitters, please apply the sum of the individual voltages. This is also true of analog systems. All of the power values are for an ambient temperature of +40 °C.

3 Port Patch Panels

- 19" front panel
- Access to the interlock terminal strip provided at the front
- Slim design panels with minimum height are supplied with loose interlock terminal strip
- U-links with interlock system 1 (IL 1-4)
- Measurement at the front possible

Part Number		BN 547171 Standard BN 547171C0101 Slim Design	BN 554175 Standard BN 554175C0101 Slim Design	BN 553431C0100 Standard BN 553431C0101 Slim Design
Frequency range		0 - 860 MHz		
Proof voltage		≤ 2.7 kV	≤ 10 kV	≤ 13 kV
Average power	100 MHz 240 MHz 860 MHz	≤ 5.0 kW ≤ 3.5 kW ≤ 2.0 kW	≤ 20.0 kW ≤ 13.5 kW ≤ 7.0 kW	≤ 51.0 kW ≤ 34.0 kW ≤ 17.5 kW
Insertion loss		≤ 0.1 dB		
VSWR		≤ 1.04		
Switching port size		7-16 female	1 5/8" USL-D	29.5-68 USL-D
Input / output connectors		7-16 female	1 5/8" EIA male	3 1/8" EIA
Number of interlock contacts		4		
Rating of the interlock contacts		Max. voltage ≤ 60.0 V DC ≤ 42.4 V ACpk Max. current ≤ 0.75 A		
Dimensions (H x W x D) mm		BN 547171 266 x 483 x 35	BN 554175 309 x 483 x 65	BN 553431C0100 444 x 483 x 115
		BN 547171C0101 132 x 483 x 15	BN 554175C0101 177 x 483 x 65	BN 553431C0101 266 x 483 x 115
Weight		≈ 3.6 kg	≈ 6.0 kg	≈ 9.6 kg
Rack		No		
Environmental conditions		For limitations see „Environmental Conditions for Broadcast Products“.		
Accessories				
Measurement adapters		See U-links and measurement adapters.		

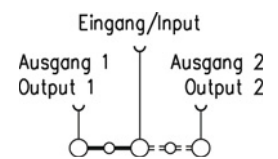

4 Port Patch Panels

- 19" front panel
- Access to the interlock terminal strip provided at the front
- Slim design panels with minimum height are supplied with loose interlock terminal strip
- U-links with interlock system 1 (IL 1-4)
- Measurement at the front possible

Part Number		BN 547174 Standard BN 547174C0101 Slim Design	BN 554174 Standard BN 554174C0101 Slim Design
Frequency range		0 - 860 MHz	
Proof voltage		≤ 2.7 kV	≤ 10 kV
Average power	100 MHz 240 MHz 860 MHz	≤ 5.0 kW ≤ 3.5 kW ≤ 2.0 kW	≤ 20.0 kW ≤ 13.5 kW ≤ 7.0 kW
Insertion loss		≤ 0.1 dB	
VSWR		≤ 1.04	
Switching port size		7-16 female	1 5/8" USL-D
Input / output connectors		7-16 female	1 5/8" EIA male
Number of interlock contacts		4	
Rating of the interlock contacts		Max. voltage ≤ 60.0 V DC ≤ 42.4 V ACpk Max. current ≤ 0.75 A	
Dimensions (H x W x D) mm		BN 547174 310 x 483 x 35 BN 547174C0101 221 x 483 x 15	BN 554174 444 x 483 x 65 BN 554174C0101 310 x 483 x 65
Weight		≈ 4.6 kg	≈ 8.5 kg
Rack		No	
Environmental conditions		For limitations see „Environmental Conditions for Broadcast Products“.	
Accessories			
Measurement adapters		See U-links and measurement adapters.	

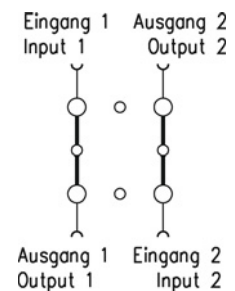

4 Port Patch Panels

- 19" front panel
- Access to the interlock terminal strip provided at the front
- Slim design panels with minimum height are supplied with loose interlock terminal strip
- U-links with interlock system 1 (IL 1-4)
- Measurement at the front possible

Part Number	BN 553514C0110 Standard		BN 553802 Standard	
	BN 553514C0101 Slim design		BN 553802C0101 Slim design	
Frequency range	0 - 860 MHz			
Proof voltage	≤ 13 kV		≤ 19 kV	
Average power	100 MHz 240 MHz 860 MHz	≤ 51.0 kW ≤ 34.0 kW ≤ 17.5 kW	≤ 98 kW ≤ 67 kW ≤ 35 kW	
Insertion loss	≤ 0.1 dB			
VSWR	≤ 1.04			
Switching port size	29.5-68 USL-D		43-98 USL-D	
Input / output connectors	3 1/8" EIA		4 1/2" EIA male 339 IEC 50-105	
Number of interlock contacts	4			
Rating of the interlock contacts	Max. voltage ≤ 60.0 V DC ≤ 42.4 V ACpk Max. current ≤ 0.75 A			
Dimensions (H x W x D) mm	BN 553514C0110 444 x 483 x 86		BN 553802 622 x 483 x 59	
	BN 553514C0101 310 x 483 x 86		BN 553802C0101 532 x 483 x 59	
Weight	≈ 11 kg		≈ 22 kg	
Rack	No			
Environmental conditions	For limitations see „Environmental Conditions for Broadcast Products“.			
Accessories				
Measurement adapters	See U-links and measurement adapters.			



Patch Panels

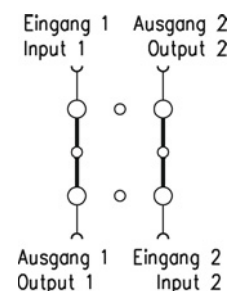

4 Port Patch Panels for Plug-In Switch

- Plug-in switch can be replaced by U-link (standard U-link or special U-link with identical electric length)
- Interlock signals are provided for plug-in switch and U-link operation
- 19" front panel
- Measurement at the front possible

Part Number		BN 553229C0100	BN 553567C0100	BN 553872C0100
Frequency range		0 - 860 MHz		
Proof voltage, limited by plug-in switch		≤ 7 kV	≤ 8.1 kV	≤ 12.5 kV
Average power	100 MHz 240 MHz 860 MHz	≤ 20.0 kW ≤ 13.5 kW ≤ 7.0 kW	≤ 41 kW ≤ 21 kW ≤ 14 kW	≤ 82 kW ≤ 42 kW ≤ 28 kW
Insertion loss		≤ 0.1 dB		
VSWR		≤ 1.04		
Switching port size		1 5/8" USL-D	29.5-68 USL-D	43-98 USL-D
Input / output connectors		1 5/8" EIA male	3 1/8" EIA	4 1/2" EIA male 339 IEC 50-105
Number of interlock contacts		4		
Rating of the interlock contacts	Max. voltage	≤ 60.0 V DC ≤ 42.4 V ACpk		
	Max. current	≤ 0.75 A		
Dimensions (H x W x D) mm		266 x 483 x 45	355 x 483 x 86	533 x 83 x 59
Weight		≈ 9.5 kg	≈ 11 kg	≈ 23 kg
Rack		No		
Environmental conditions		For limitations see „Environmental Conditions for Broadcast Products“.		
Accessories				
Plug-in switch		BN 553064 BN 553065	BN 553364 BN 553365	BN 553664 BN 553665
19" front panel with 4 parking sockets		BN 553251	BN 554344	BN 553749
U-link standard		BN 553031	BN 553331	BN553611
U-link with identical electrical length as plug-in switch		BN 553033	BN 553334	-
Measurement adapters		BN 553048	BN 553348	BN553648

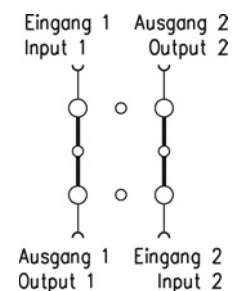
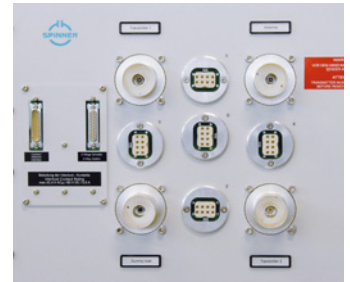

6 Port Patch Panels (FM)

- Open rack
- Access to the interlock terminal strip provided at the front
- Symmetrical power splitter included
- U-links with interlock system 2 (IL 2-10)
- Measurement at the front possible

Part Number	BN 553283A0200	BN 553472A0200	BN 553888A0200	BN 540658A0200
Frequency range	87 - 108 MHz			
Proof voltage	≤ 10 kV	≤ 13 kV	≤ 19 kV	≤ 23 kV
Average power 100 MHz	≤ 20 kW	≤ 51 kW	≤ 98 kW	≤ 132 kW
Insertion loss	≤ 0.1 dB			
VSWR	≤ 1.06			
Switching port size	1 5/8" USL-D	29.5-68 USL-D	43-98 USL-D	52-120 USL
Input / output connectors	1 5/8" EIA male	3 1/8" EIA	4 1/2" EIA male 339 IEC 50-105	6 1/8" EIA
Number of interlock contacts	10			
Rating of the interlock contacts Max. voltage	≤ 60.0 V DC			
Max. current	≤ 42.4 V ACpk ≤ 0.1 A			
Phase accuracy of outputs	3°			
Dimensions (H x W x D) mm	1980 x 575 x 600		1980 x 790 x 800	1980 x 990 x 900
Weight	≈ 60 kg	≈ 75 kg	≈ 150 kg	≈ 200 kg
Rack	Yes			
Environmental conditions	For limitations see „Environmental Conditions for Broadcast Products“.			
Accessories				
Measurement adapters	See U-links and measurement adapters.			



Patch Panels

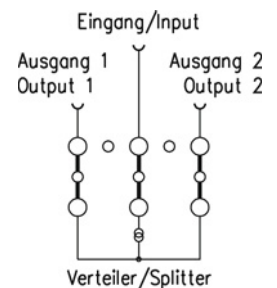

6 Port Patch Panels (VHF)

- 19" front panel
- Access to the interlock terminal strip provided at the front
- Symmetrical power splitter included
- U-links with interlock system 1 (IL 1-4) or 2 (IL 2-10)
- Measurement at the front possible

Part Number	BN 553284	BN 554343	BN 554507
Frequency range	170 - 240 MHz		
Proof voltage	≤ 10 kV	≤ 13 kV	≤ 18 kV
Average power	≤ 13.5 kW	≤ 34 kW	≤ 48 kW
Insertion loss	≤ 0.1 dB		
VSWR	≤ 1.05		
Switching port size	1 5/8" USL-D	29.5-68 USL-D	43 – 98 USLD
Input / output connectors	1 5/8" EIA male	3 1/8" EIA	4 1/2" EIA male 339 IEC 50-105
Number of interlock contacts	4		10
Rating of the interlock contacts Max. voltage	≤ 60.0 V DC ≤ 42.4 V ACpk		
Max. current	≤ 0.75 A		≤ 0.1 A
Phase accuracy of outputs	3°		
Dimensions (H x W x D) mm	444 x 483 x 264		1980 x 790 x 900
Weight	≈ 25 kg	≈ 34 kg	≈ 150 kg
Rack	No		Yes
Environmental conditions	For limitations see „Environmental Conditions for Broadcast Products“.		
Accessories			
Measurement adapters	See U-links and measurement adapters.		

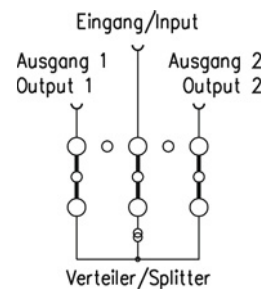
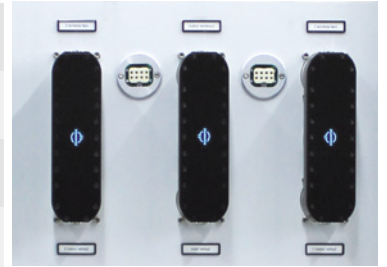

3 Port Patch Panels (UHF)

- 19" front panel
- Access to the interlock terminal strip provided at the front
- Symmetrical power splitter integrated in U-link (included)
- U-links with interlock system 1 (IL 1-4) or 2 (IL 2-10)
- Measurement at the front possible

Part Number	BN 547110C0100	BN 547110C0200
Frequency range	470 - 800 MHz	
Proof voltage	≤ 2 kV	
Average power	1 kW	
Insertion loss	≤ 0.03 dB	
VSWR	≤ 1.17	
Switching port size	7-16 female	
Input / output connectors	7-16 female	
Number of interlock contacts	4	10
Rating of the interlock contacts	≤ 60.0 V DC ≤ 42.4 V ACpk	
Max. voltage		
Max. current	≤ 0.75 A	≤ 0.1 A
Phase accuracy of outputs	3°	
Dimensions (H x W x D) mm	133 x 483 x 98	
Weight	≈ 5 kg	
Rack	No	
Environmental conditions	For limitations see "Environmental Conditions for Broadcast Products".	
Accessories		
Measurement adapters	See U-links and measurement adapters.	



full antenna mode



half antenna mode

Patch Panels

6 Port Patch Panels (UHF)

- 19" front panel
- Access to the interlock terminal strip provided at the front
- Symmetrical power splitter included
- U-links with interlock system 1 (IL 1-4) or 2 (2-10)
- Measurement at the front possible

Part Number	Interlock 1 Interlock 2	BN 553285C0100 BN 553282C0200	BN 553579C0100 BN 553576C0200
Frequency range		470 - 860 MHz	
Proof voltage		≤ 10 kV	≤ 13 kV
Average power		≤ 7 kW	≤ 17.5 kW
Insertion loss		≤ 0.15 dB	≤ 0.10 dB
VSWR		≤ 1.05	
Switching port size		1 5/8" USL-D	29.5-68 USL-D
Input / output connectors		1 5/8" EIA male	3 1/8" EIA
Number of interlock contacts		4/10	
Rating of the interlock contacts		Max. voltage ≤ 60.0 V DC ≤ 42.4 V ACpk Max. current ≤ 0.75 A / 0.1 A	
Phase accuracy of outputs		3°	
Dimensions (H x W x D) mm		444 x 483 x 260	488 x 483 x 260
Weight		≈ 25 kg	≈ 34 kg
Rack		No	
Environmental conditions		For limitations see „Environmental Conditions for Broadcast Products“.	
Accessories			
Measurement adapters		See U-links and measurement adapters.	

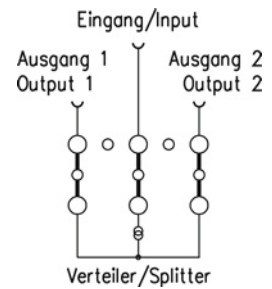

6 Port Patch Panels (UHF)

- Open rack
- Access to the interlock terminal strip provided at the front
- Symmetrical power splitter included
- U-links with interlock system 2 (IL 2-10)
- Measurement at the front possible

Part Number	BN 553881A0200	BN 540642A0200	BN 540652A0200	BN 540643A0200
Frequency range	470 - 860 MHz			
Proof voltage	≤ 19 kV	≤ 23 kV	≤ 25 kV	
Average power	≤ 35 kW	≤ 47 kW	≤ 60 kW	≤ 80 kW (800 MHz)
Insertion loss	≤ 0.1 dB			≤ 0.05 dB
VSWR	≤ 1.05			
Switching port size	43-98 USL-D	52-120 USL	6 1/8" USL	
Input / output connectors	4 1/2" EIA male 339 IEC 50-105	6 1/8" EIA		
Number of interlock contacts	10			
Rating of the interlock contacts	Max. voltage ≤ 60.0 V DC ≤ 42.4 V ACpk Max. current ≤ 0.1 A			
Phase accuracy of outputs	3°			
Dimensions (H x W x D) mm	1980 x 790 x 900	1980 x 990 x 900		1980 x 1190 x 900
Weight	≈ 145 kg	≈ 180 kg		≈ 215 kg
Rack	Yes			
Environmental conditions	For limitations see „Environmental Conditions for Broadcast Products“.			
Accessories				
Measurement adapters	See U-links and measurement adapters.			



Patch Panels

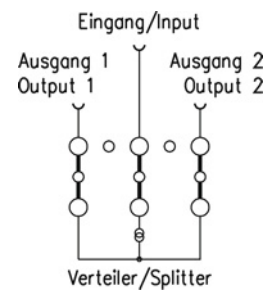

U-links and Measurement Adapters

- Fast switching
- 4 or 10 interlock contacts IL1-4 or IL 2-10
- Instant RF-connection and shielding
- Best repeat accuracy
- Measurement adapters for accurate measurement of combiners, feeders and antennas from front side



U-link with interlock system 1 (IL 1-4)



U-link with interlock system 2 (IL 2-10)



Measurement adapters

U-link with Interlock System 1 (IL 1-4) and 2 (IL 2-10)

Part Number	Interlock 1 Interlock 2	BN 540121 -	BN 553031 BN 553032	BN 553331 BN 553332	BN 553611 BN 553612	- BN 539627	- BN 539613	- BN 539633
Frequency range		0 - 860 MHz						0 - 800 MHz
Proof voltage		≤ 2.7 kV	≤ 10 kV	≤ 13 kV	≤ 19 kV	≤ 23 kV	≤ 25 kV	≤ 34 kV
Average power	100 MHz 240 MHz 860 MHz	≤ 5.0 kW ≤ 3.5 kW ≤ 2.0 kW	≤ 20.0 kW ≤ 13.5 kW ≤ 7.0 kW	≤ 51.0 kW ≤ 34.0 kW ≤ 17.5 kW	≤ 98.0 kW ≤ 67.0 kW ≤ 35.0 kW	≤ 132.0 kW ≤ 91.0 kW ≤ 47.0 kW	≤ 169.0 kW ≤ 116.0 kW ≤ 60.0 kW	≤ 225.0 kW ≤ 154.0 kW ≤ 80.0 kW *
Connectors		7-16	158 USL-D	68 USL-D	98 USL-D	120 USL	120 USL	618 USL
Distance between axles		110 mm	160 mm	160 mm	225 mm	325 mm	325 mm	400 mm
Weight		≈ 0.6 kg	≈ 1 kg	≈ 1.7 kg	≈ 4.7 kg	≈ 9.4 kg	≈ 10 kg	≈ 22 kg
Option								
U-link with identical electrical length as plug-in switch		-	BN 553033	BN 553334	-	-	-	-

* @ 800 MHz

Precision Measurement Adapters to 7-16 female

Part Number	-	BN 553048	BN 553348	BN 553648	BN 539648	BN 539647 *
Connectors	-	158 USL-D	29.5-68 USL-D	43-98 USL-D	52-120 USL	618 USL
VSWR	-	≤ 1.02	≤ 1.02	≤ 1.02	≤ 1.02	≤ 1.02
Environmental conditions	For limitations see „Environmental Conditions for Broadcast Products“.					

* @ 800 MHz

Parallel Switching Units



Parallel switching units are used to double the output power by combining two transmitters that operate at the same frequency and have a phase differential of 90°.

Typically, the failure of one transmitter will cause the output power to drop by 75% because half of the power from the working transmitter then flows into the balancing load of the 3 dB coupler.

The SPINNER parallel switching unit can route transmitter 1 or transmitter 2 straight to the antenna and transmitter 2 or transmitter 1 to the dummy load within seconds.

As a result, 50% of the original output power then once again becomes available and the disconnected transmitter is freed for repair or maintenance work. The combined

output of both transmitters can also be routed to the dummy load for measurements.

Switching is done by remotely controlled, motorized two-way switches. In an emergency, the switches can also be operated manually or replaced by U-links. Interlock contacts are available in all cases.

SPINNER supplies parallel switching units for FM, VHF and UHF with various power ratings for analog and digital transmission.

Parallel Switching Units

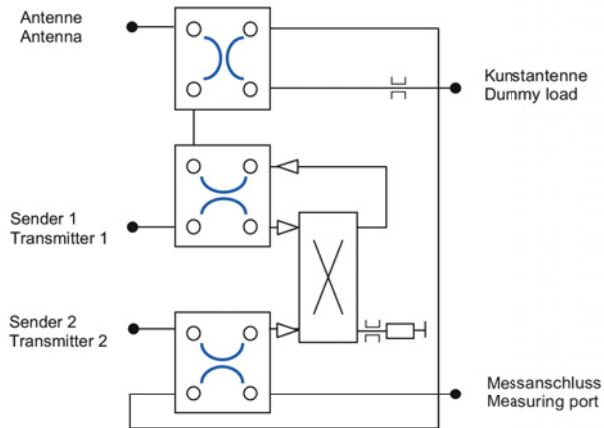

Switching Possibilities

Standard operation:

- Transmitters TX1 and TX2 to antenna
- Measuring port to dummy load

Emergency operation:

- Working transmitter to antenna
- Defective transmitter to dummy load for measurement or repair

Testing:

- Transmitters TX1 and TX2 to dummy load
- Measuring port to antenna

UHF 30 kW Switchless Combiners

Switchless Combiner for Active-Reserve Transmitters

It is common practice to combine the power of two transmitters via 3 dB couplers to double the output power during normal operation. To prevent the power supply to the antenna from dropping by three-fourths if one transmitter fails, the good transmitter is switched directly through to the antenna while the faulty one is isolated for repair. If this is performed by manual U-links, it is necessary to interrupt transmission for a few minutes.

Even if switching is done by motorized switches, transmission has to be interrupted because the switches don't permit hot switching. The switchless combiner performs the switchover by phase shifting, thus rerouting the signals without any interruption of transmission.

SPINNER has supplied many conventional parallel switching units with U-links or motorized switches and now also offers switchless combiners in "SPINNER quality" as an alternative. Before explaining the details of the switchless combiner, we will compare the advantages of these two competing approaches and explain why SPINNER offers both.

Parallel switching units with U-links or motorized switches:

- No hot switching
- High isolation of transmitters by galvanic separation of RF paths via switches or U-links
- Functionality defined by switch positions independently of the operating frequency

Switchless combiner with trombone line phase shifter:

- Hot switching
- Transmitters are not galvanically isolated; 35 dB of isolation is provided by 3 dB couplers
- Functionality is defined by the position of the trombone and requires readjustment if the frequency changes.

The SPINNER switchless combiner consists of two hybrid couplers connected by a fixed transmission line and a motor-driven trombone line acting as a mechanical phase shifter. A sophisticated control unit makes the switchless combiner as easy to handle as a parallel switching unit, permitting both local and remote control.

The switchless combiner can be tuned in the factory to any channel in the UHF band. To start operating, the switchless combiner only needs to be connected to a power source. Selecting the operating mode is easy: for remote mode, apply a signal to the appropriate input pin; for local mode, press the corresponding button on the control panel.

The control unit then starts the motor to move the phase shifter into a predefined position and reroute the RF signal. The transmitters can continue operating without interruption while the phase shifter is moving; the input ports are always matched, and the power is correctly routed at all times.

The SPINNER switchless combiner also includes safety and emergency functions:

- It retains its position even if control signals or the power supply are interrupted, resuming operation when the signals return.
- It can be operated manually.
- There is a set of potential-free signaling switches that are independent of the control unit and power supply. They indicate whether the switchless combiner has gone into the right operating mode.
- The control unit sends warning and error signals.

The switchless combiner can be readjusted on-site to any channel in the UHF band. This is done by using a network analyzer to locate the new positions of the phase shifter and optimizing the 3 dB couplers.

SPINNER supplies a full range of accessories for installing, retuning and operating the switchless combiner:

- Loads
- Monitoring couplers
- Measurement adapters and calibration kits

SPINNER supplies the switchless combiner as an alternative for network operators whose priority is to prevent any interruption of transmission.

Note:

The RF signals from the transmitters must be adjusted to ensure that they are in phase at the inputs.

UHF 30 kW Switchless Combiner

- Hot switching
- Simple remote control of all functions
- Feedback of operation mode and interlock signals
- Suitable for analogue and digital TV
- For 6, 7 and 8 MHz channel bandwidth
- Tuneable within the whole UHF range
- CCS compact design

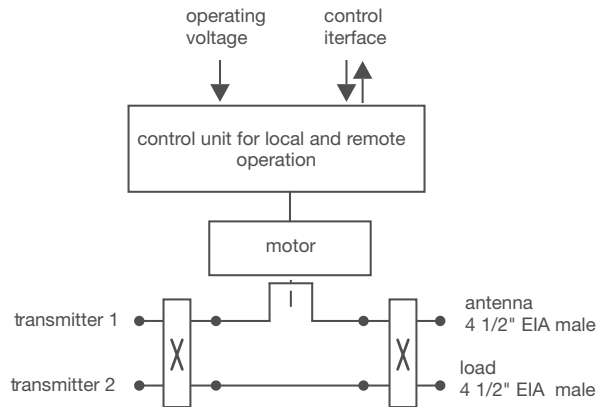

Part Number	BN 536574
Frequency range	470 - 860 MHz
Input power	≤ 15 kW per input
Proof voltage	16 kV
Insertion loss	≤ 0.15 dB
Isolation between inputs	≥ 35 dB
VSWR	≤ 1.1
Operation modes	TX1+TX2 to antenna TX1 to antenna and TX2 to load TX2 to antenna and TX1 to load TX1+TX2 to load
Switching time	10 - 20 s
Operation control	Local via front panel or remote by control signals
RF input	3 1/8" EIA male
RF output	4 1/2" EIA male 339 IEC 50-105
Remote control interface	DC-37-D-sub or terminal block
Operating voltage interface	IEC 60320 C14 male
Operating voltage	85 - 250 V AC; 47 - 63 Hz
Operating current	≤ 3 A
Control signal inputs	8 - 24 V DC
Control signal outputs	Potention-free relay contact or switches; V ≤ 60 V DC; I ≤ 30 A
Dimensions (H x W x D) mm	900 x 390 x 1420
Weight	≈ 97 kg
Environmental conditions *)	Max. altitude AMSL 1.600 ft (limited by power supply)



*) For limitations see „Environmental Conditions for Broadcast Products“.

Two-Way Coaxial Switches



SPINNER supplies a wide variety of switch types for highly demanding applications. Their RF ratings range from a few watts to several hundred kilowatts, and they are available for sizes from N to 6 1/8" EIA and frequencies up to several GHz.

SPINNER's RF switches consist of different drive types (lifting magnet, impulse solenoid or motor drive) for switching times from 25 ms up to about one second. The two-way switches, which come in 4 1/2" IEC and 6 1/8" EIA, are the fastest RF switches available in the marketplace.

Due to their extremely compact dimensions and exceptional dependability, SPINNER switches are preferred for

systems that must be highly reliable. The 2+1 and 4+1 switching units developed by SPINNER are excellently suited for ensuring operation of redundant systems. In 19" rack systems, these compact switching systems have a height of only 1 rack unit yet are able to keep remote stations broadcasting even if a transmitter should fail.

Two-Way Coaxial Switches

Manual Operation

With manually operated switches, the switch position is selected using a knob. The switch locks at its end positions to reliably maintain them even if it is subjected to vibrations or rotates around a rotor axis

Impulse Solenoid Drive

In switches with an impulse solenoid drive, the rotor torque is generated by a rotating permanent magnet surrounded by a stationary coil. The drive system has two stable switching positions and locks in both end positions (i.e. it is latching). A pulse is therefore sufficient as a control signal (no control voltage is required after switching). In the event of a power failure or system restart, the most recent switch position is retained.

There is also a failsafe switch version that is reset to its initial position by a spring if the power fails.

Lifting Magnet Drive

In this version, electromagnetic force moves a lever from its resting position to its final position. When the current stops, the lever is reset to its resting position by an externally applied force such as a spring. Either the drive is not locked in either position (monostable) or else it is held in place by an auxiliary magnet (bistable).

Motor Drive

Motorized switches are turned by a special gear mechanism developed by SPINNER (see “hypocycloid gear mechanism” below). This drive system rotates by 90° and locks in both end positions.

Hypocycloid Gear Mechanism

The drive and switch base (rotor) are connected by a special gear mechanism developed by SPINNER. This mechanism varies the torque and angular velocity across the switch's rotational range. Initially, the torque is very high while the angular velocity of the switch rotor is very low. Then, as the angle increases the angular velocity steadily increases while the torque decreases. After passing the middle of the range, this is reversed and the angular velocity decreases while the torque increases. The drive mechanically locks in both end positions.

Signaling and Interlock Contacts

Potential-free SPDT contacts (signaling contacts) indicate the current switch position.

The interlock contacts are coupled with RF contacts for interrupting RF power before and during switching. They open before the RF contacts separate and closes after the RF contacts are in their new position.

The maximum switching limits of these contacts are 42.4 V ACpk / 60 V DC / 0.5 A. For BN 512663 and BN 512665 the limits are 42.4 V ACpk / 50 V DC / 0.1 A.

Protection Class

The protection class is IP40 (EN60529), meaning that the switches are only suitable for indoor use. Switches for outdoor installation are also available on request.

Power Ratings

All power ratings apply to room temperature (about 25 °C), normal air pressure (about 1000 hPa), relative humidity of about 50% and an RF-matched state. Specified power ratings are for the highest given frequency and can be transmitted via both switch paths concurrently. If you require operation with pulsed power, please send us detailed data.

Dimensions

All dimensions are in mm.

Note:

The maximum average transmittable power of digital signals (e.g. DAB, DVB-T, ATSC, ISDB-T etc.) is rated by applying an RF proof voltage while taking the crest factor into account. When operating multiple transmitters with analog or digital signals, the sum of their voltages must be considered.

Two-Way Switch DPDT with N Connectors, Manual Operation

- Optical position indicator

Part Number	BN 754645	
Connectors	N female	
Frequency range	0 - 5 GHz	
Proof voltage	≤ 3.0 kV	
Average power ¹	0 - 1 GHz	≤ 0.79 kW
	1 - 2 GHz	≤ 0.56 kW
	2 - 3 GHz	≤ 0.45 kW
	3 - 5 GHz	≤ 0.35 kW
VSWR	0 - 1 GHz	≤ 1.03
	1 - 2 GHz	≤ 1.13
	2 - 3 GHz	≤ 1.13
	3 - 5 GHz	≤ 1.22
Isolation	0 - 1 GHz	≥ 75 dB
	1 - 2 GHz	≥ 60 dB
	2 - 3 GHz	≥ 60 dB
	3 - 5 GHz	≥ 50 dB
Insertion loss	0 - 1 GHz	≤ 0.04 dB
	1 - 2 GHz	≤ 0.04 dB
	2 - 3 GHz	≤ 0.06 dB
	3 - 5 GHz	≤ 0.06 dB
Mechanical life (cycles)	≥ 500,000	
Ambient temperature	-10 °C ≤ ϑ ≤ +45 °C	
Weight	≈ 0.35 kg	

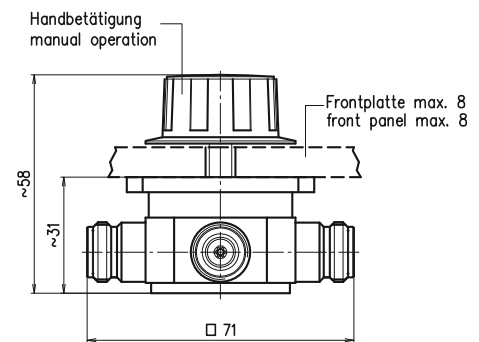

¹ For limitations see "Environmental Conditions for Broadcast Products".

Two-Way Switch DPDT with N Connectors, Manual Operation

- Optical position indicator
- End position signal contacts

Part Number	BN 754070	
Connectors	N female	
Frequency range	0 - 5 GHz	
Proof voltage	≤ 3.0 kV	
Average power ¹	0 - 1 GHz	≤ 0.79 kW
	1 - 2 GHz	≤ 0.56 kW
	2 - 3 GHz	≤ 0.45 kW
	3 - 5 GHz	≤ 0.35 kW
VSWR	0 - 1 GHz	≤ 1.03
	1 - 2 GHz	≤ 1.13
	2 - 3 GHz	≤ 1.13
	3 - 5 GHz	≤ 1.22
Isolation	0 - 1 GHz	≥ 75 dB
	1 - 2 GHz	≥ 60 dB
	2 - 3 GHz	≥ 60 dB
	3 - 5 GHz	≥ 50 dB
Insertion loss	0 - 1 GHz	≤ 0.04 dB
	1 - 2 GHz	≤ 0.04 dB
	2 - 3 GHz	≤ 0.06 dB
	3 - 5 GHz	≤ 0.06 dB
Mechanical life (cycles)	≥ 500,000	
Ambient temperature	-10 °C ≤ ϑ ≤ +45 °C	
Weight	≈ 0.50 kg	

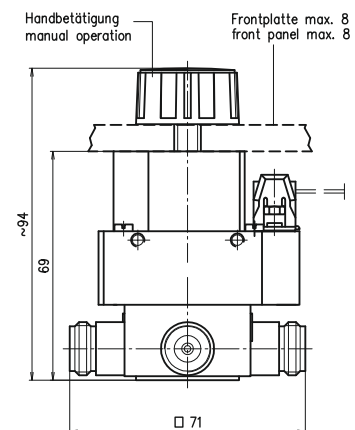

¹ For limitations see "Environmental Conditions for Broadcast Products".

Two-Way Switch DPDT with N Connectors, Failsafe

- Solenoid drive
- Manual operation
- End position signal contacts

Part Number	BN 743741	
Connectors	N female	
Frequency range	0 - 2 GHz	
Proof voltage	≤ 3.0 kV	
Average power ¹	0 - 1 GHz 1 - 2 GHz	≤ 0.30 kW ≤ 0.20 kW
VSWR	0 - 1 GHz 1 - 2 GHz	≤ 1.12 ≤ 1.15
Isolation	0 - 1 GHz 1 - 2 GHz	≥ 70 dB ≥ 65 dB
Insertion loss	0 - 1 GHz 1 - 2 GHz	≤ 0.06 dB ≤ 0.07 dB
Operation voltage	24 V DC ± 10 %	
Control voltage	24 V DC ± 10 %	
Operation current	≤ 0.2 A	
Switching time	≤ 25 ms	
Mechanical life (cycles)	≥ 2,000,000	
Ambient temperature	-10 °C ≤ ϑ ≤ +45 °C	
Weight	≈ 0.35 kg	

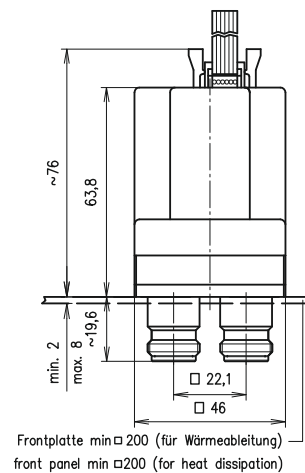

¹ For limitations see "Environmental Conditions for Broadcast Products".

Two-Way Switch DPDT with N Connectors, Latching

- Impulse solenoid drive
- Optical position indicator
- Manual operation
- End position signal contacts

Part Number	BN 754067	
Connectors	N female	
Frequency range	0 - 2 GHz	
Proof voltage	≤ 2.3 kV	
Average power ¹	0 - 1 GHz 1 - 2 GHz	≤ 0.75 kW ≤ 0.50 kW
VSWR	0 - 1 GHz 1 - 2 GHz	≤ 1.04
Isolation	0 - 1 GHz 1 - 2 GHz	≥ 80 dB ≥ 75 dB
Insertion loss	0 - 2 GHz	≤ 0.05 dB
Operation voltage	24 V DC ± 10 %	
Control voltage	24 V DC ± 10 %	
Operation current	≤ 0.8 A	
Switching time	≤ 80 ms	
Mechanical life (cycles)	≥ 250,000	
Ambient temperature	-10 °C ≤ ϑ ≤ +45 °C	
Weight	≈ 0.45 kg	



Handbetätigung / Positionsanzeige
manual operation / position indication

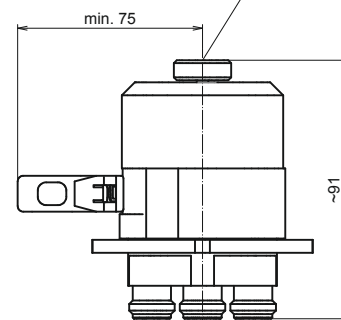

¹ For limitations see "Environmental Conditions for Broadcast Products".

Two-Way Switches DPDT with N Connectors, Latching

- Impulse solenoid drive
- Optical position indicator
- Manual operation
- End position signal contacts

Part Number	BN 754098	BN 754030
Connectors	N female	
Frequency range	0 - 5 GHz	
Proof voltage	≤ 3.0 kV	
Average power ¹	0 - 1 GHz 1 - 2 GHz 2 - 3 GHz 3 - 5 GHz	≤ 0.79 kW ≤ 0.56 kW ≤ 0.45 kW ≤ 0.35 kW
VSWR	0 - 1 GHz 1 - 2 GHz 2 - 3 GHz 3 - 5 GHz	≤ 1.03 ≤ 1.13 ≤ 1.13 ≤ 1.22
Isolation	0 - 1 GHz 1 - 2 GHz 2 - 3 GHz 3 - 5 GHz	≥ 75 dB ≥ 60 dB ≥ 60 dB ≥ 50 dB
Insertion loss	0 - 1 GHz 1 - 2 GHz 2 - 3 GHz 3 - 5 GHz	≤ 0.04 dB ≤ 0.04 dB ≤ 0.06 dB ≤ 0.06 dB
Operating voltage	12 V DC ± 5 %	25 V DC ± 10 %
Control voltage	12 V DC ± 5 %	25 V DC ± 10 %
Operating current	≤ 0.9 A	≤ 0.6 A
Switching time	≤ 40 ms	
Mechanical life (cycles)	≥ 250,000	
Ambient temperature	-10 °C ≤ ϑ ≤ +45 °C	
Weight	≈ 0.6 kg	

¹ For limitations see "Environmental Conditions for Broadcast Products".

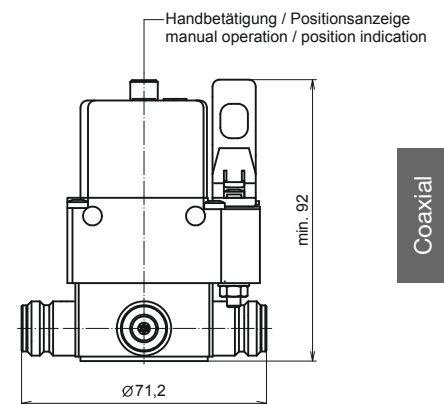

Two-Way Switches DPDT with N Connectors, Latching

- Impulse solenoid drive
- Optical position indicator
- Manual operation
- Advanced interlock contacts
- End position signal contacts

Part Number	BN 754066C0001	BN 754066C0002
Connectors	N female	
Frequency range	0 - 5 GHz	
Proof voltage	≤ 3.0 kV	
Average power ¹	0 - 1 GHz	≤ 0.79 kW
	1 - 2 GHz	≤ 0.56 kW
	2 - 3 GHz	≤ 0.45 kW
	3 - 5 GHz	≤ 0.35 kW
VSWR	0 - 1 GHz	≤ 1.03
	1 - 2 GHz	≤ 1.13
	2 - 3 GHz	≤ 1.13
	3 - 5 GHz	≤ 1.22
Isolation	0 - 1 GHz	≥ 75 dB
	1 - 2 GHz	≥ 60 dB
	2 - 3 GHz	≥ 60 dB
	3 - 5 GHz	≥ 50 dB
Insertion loss	0 - 1 GHz	≤ 0.04 dB
	1 - 2 GHz	≤ 0.04 dB
	2 - 3 GHz	≤ 0.06 dB
	3 - 5 GHz	≤ 0.06 dB
Operating voltage	12 V DC ± 10 %	25 V DC ± 12 %
Control voltage	12 V DC ± 10 %	25 V DC ± 12 %
Operating current	≤ 2.0 A	≤ 1.1 A
Switching time	≤ 100 ms	
Mechanical life (cycles)	≥ 500,000	
Ambient temperature	-10 °C ≤ ϑ ≤ +60 °C	
Weight	≈ 0.8 kg	

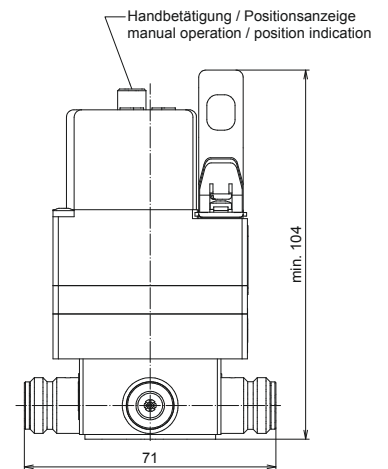

¹ For limitations see "Environmental Conditions for Broadcast Products".

Two-Way Switches DPDT with 7-16 Connectors, Latching

- Impulse solenoid drive
- Optical position indicator
- Manual operation
- Advanced interlock contacts
- End position signal contacts

Part Number	BN 512690C0001	BN 512690C0002
Connectors	7-16 female	
Frequency range	0 - 5 GHz	
Proof voltage	≤ 4.0 kV	
Average power ¹	100 MHz 230 MHz 700 MHz	≤ 5.0 kW ≤ 3.5 kW ≤ 2.0 kW
VSWR	100 MHz 230 MHz 700 MHz	≤ 1.02 ≤ 1.02 ≤ 1.04
Isolation	100 MHz 230 MHz 700 MHz	≥ 80 dB
Insertion loss	≤ 0.05 dB	
Operating voltage	12 V DC ± 10 %	25 V DC ± 12 %
Control voltage	12 V DC ± 10 %	25 V DC ± 12 %
Operating current	≤ 2.0 A	≤ 1.1 A
Switching time	≤ 100 ms	
Mechanical life (cycles)	≥ 500,000	
Ambient temperature	-10 °C ≤ ϑ ≤ +60 °C	
Weight	≈ 1.2 kg	

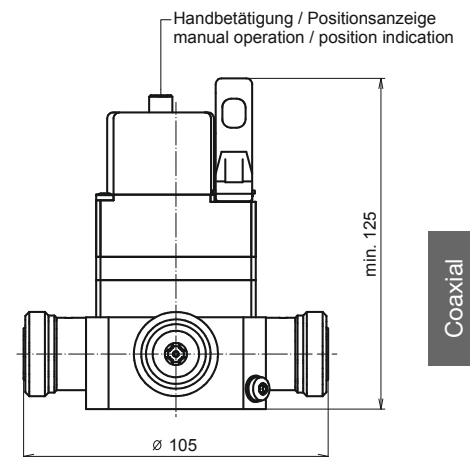

¹ For limitations see "Environmental Conditions for Broadcast Products".

Two-Way Switches DPDT with 7/8" EIA Connectors, Latching

- Motor drive
- Optical position indicator
- Manual operation
- Advanced interlock contacts
- End position signal contacts

Part Number		BN 512698	BN 512697
Connectors		7/8" EIA	
Frequency range		0 - 3.5 GHz	
Proof voltage		≤ 3.5 kV	
Average power ¹	100 MHz	≤ 7.5 kW	
	230 MHz	≤ 4.5 kW	
	700 MHz	≤ 2.4 kW	
VSWR	100 MHz	≤ 1.02	
	230 MHz	≤ 1.02	
	700 MHz	≤ 1.04	
Isolation	100 MHz	≥ 80 dB	
	230 MHz		
	700 MHz		
Insertion loss		≤ 0.03 dB	
Operating voltage		230 V AC ± 10 % 50 - 60 Hz	
Control voltage		8 - 31 V DC	230 V AC ± 10 % 50 - 60 Hz
Operating current		≤ 0.5 A	
Switching time ¹		≤ 120 ms	
Mechanical life (cycles)		≥ 250,000	
Ambient temperature		-10 °C ≤ θ ≤ +60 °C	
Weight		≈ 2.5 kg	

¹ For limitations see "Environmental Conditions for Broadcast Products".

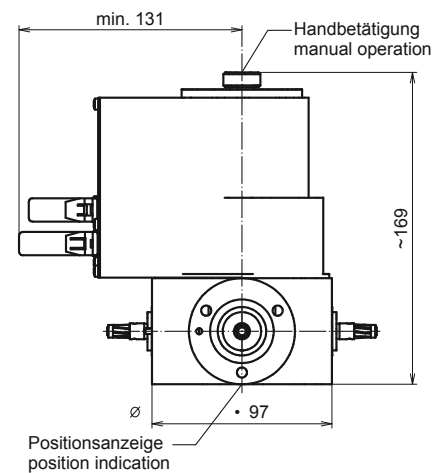

Two-Way Switches DPDT with 1 5/8" EIA Connectors, Latching

- Motor drive
- Optical position indicator
- Manual operation
- Advanced interlock contacts
- End position signal contacts

Part Number		BN 640082	BN 640081
Connectors		1 5/8" EIA	
Frequency range		0 - 2.0 GHz	
Proof voltage		≤ 5.1 kV	
Average power ¹	100 MHz 230 MHz 700 MHz	≤ 19.0 kW ≤ 12.7 kW ≤ 6.6 kW	
VSWR	100 MHz 230 MHz 700 MHz	≤ 1.03 ≤ 1.03 ≤ 1.05	
Isolation	100 MHz 230 MHz 700 MHz	≥ 80 dB	
Insertion loss		≤ 0.05 dB	
Operating voltage		230 V AC ± 10 % 50 - 60 Hz	
Control voltage		8 - 31 V DC	230 V AC ± 10 % 50 - 60 Hz
Operating current		≤ 0.5 A	
Switching time		≤ 120 ms	
Mechanical life (cycles)		≥ 250,000	
Ambient temperature		-10 °C ≤ ϑ ≤ +60 °C	
Weight		≈ 5.0 kg	

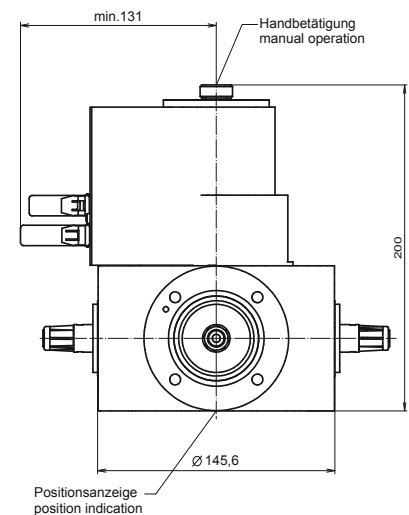

¹ For limitations see "Environmental Conditions for Broadcast Products".

Two-Way Switches DPDT with 3 1/8" EIA Connectors, Latching

- Motor drive
- Optical position indicator
- Manual operation
- Advanced interlock contacts
- End position signal contacts

Part Number		BN 941918	BN 941917
Connectors		3 1/8" EIA	
Frequency range		0 - 860 MHz	
Proof voltage		≤ 13.3 kV	
Average power ¹	100 MHz 230 MHz 700 MHz	≤ 70 kW ≤ 46 kW ≤ 24 kW	
VSWR	100 MHz 230 MHz 700 MHz	≤ 1.03 ≤ 1.03 ≤ 1.05	
Isolation	100 MHz 230 MHz 700 MHz	≥ 75 dB	
Insertion loss		≤ 0.05 dB	
Operating voltage		230 V AC ± 10 % 50 - 60 Hz	
Control voltage		8 - 31 V DC	230 V AC ± 10 % 50 - 60 Hz
Operating current		≤ 1.0 A	
Switching time		≤ 200 ms	
Mechanical life (cycles)		≥ 250,000	
Ambient temperature		-10 °C ≤ θ ≤ +60 °C	
Weight		≈ 10.5 kg	

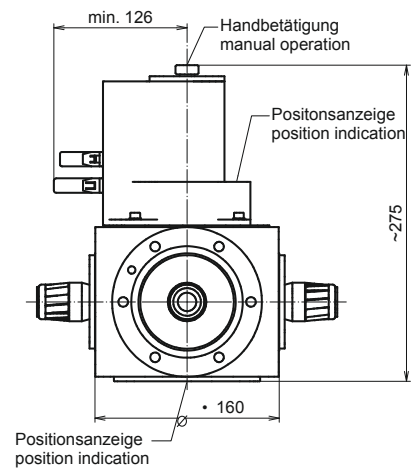

¹ For limitations see "Environmental Conditions for Broadcast Products".

Two-Way Switches DPDT with 4 1/16" EIA Connectors, Latching

- Motor drive
- Optical position indicator
- Manual operation
- Advanced interlock contacts
- End position signal contacts

Part Number		BN 941934	BN 941934C0110
Connectors		4 1/16" EIA	
Frequency range		0 - 700 MHz	
Proof voltage		≤ 16.0 kV	
Average power ¹	100 MHz 230 MHz 700 MHz	≤ 100 kW ≤ 70 kW ≤ 38 kW	
VSWR	100 MHz 230 MHz 700 MHz	≤ 1.04 ≤ 1.04 ≤ 1.06	
Isolation	100 MHz 230 MHz 700 MHz	≥ 80 dB ≥ 80 dB ≥ 70 dB	
Insertion loss		≤ 0.03 dB	
Operating voltage		230 V AC ± 10 % 50 - 60 Hz	120 V AC ± 16 % 50 - 60 Hz
Control voltage		8 - 31 V DC	
Operating current		≤ 1.5 A	
Switching time		≤ 1.0 s	
Mechanical life (cycles)		≥ 250,000	
Ambient temperature		-10 °C ≤ θ ≤ +60 °C	
Weight		≈ 26.5 kg	

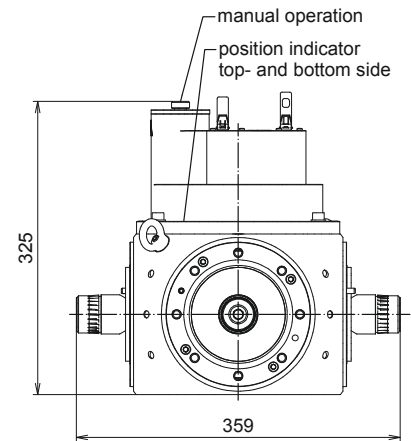

Coaxial
Switches

¹ For limitations see "Environmental Conditions for Broadcast Products".

Two-Way Switches DPDT with 4 1/2" EIA Connectors, Latching

- Motor drive
- Optical position indicator
- Manual operation
- Advanced interlock contacts
- End position signal contacts

Part Number		BN 941944	BN 941944C0110
Connectors		4 1/2" EIA	
Frequency range		0 - 700 MHz	
Proof voltage		≤ 16.0 kV	
Average power ¹	100 MHz	≤ 100 kW	
	230 MHz	≤ 70 kW	
	700 MHz	≤ 38 kW	
VSWR	100 MHz	≤ 1.04	
	230 MHz	≤ 1.04	
	700 MHz	≤ 1.06	
Isolation	100 MHz	≥ 80 dB	
	230 MHz	≥ 80 dB	
	700 MHz	≥ 70 dB	
Insertion loss		≤ 0.03 dB	
Operating voltage	230 V AC ± 10 % 50 - 60 Hz		120 V AC ± 16 % 50 - 60 Hz
	Control voltage		
Operating current		≤ 1.5 A	
Switching time		≤ 1.0 s	
Mechanical life (cycles)		≥ 250,000	
Ambient temperature		-10 °C ≤ θ ≤ +60 °C	
Weight		≈ 26.5 kg	

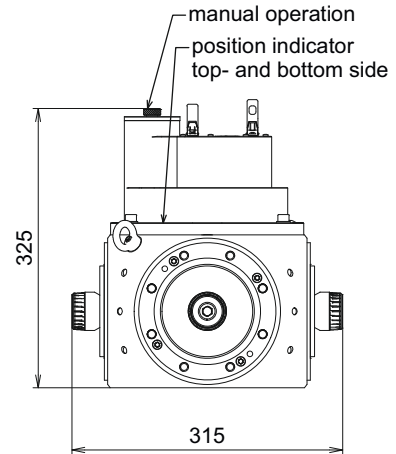

¹ For limitations see "Environmental Conditions for Broadcast Products".

Two-Way Switches DPDT with 6 1/8" EIA Connectors, Latching

- Motor drive
- Optical position indicator
- Manual operation
- Advanced interlock contacts
- End position signal contacts

Part Number		BN 941989	BN 941989C0110
Connectors		6 1/8" EIA	
Frequency range		0 - 700 MHz	
Proof voltage		≤ 18.6 kV	
Average power ¹	100 MHz 230 MHz 700 MHz	≤ 166 kW ≤ 110 kW ≤ 60 kW	
VSWR	100 MHz 230 MHz 700 MHz	≤ 1.06 ≤ 1.06 ≤ 1.08	
Isolation	100 MHz 230 MHz 700 MHz	≥ 75 dB ≥ 75 dB ≥ 70 dB	
Insertion loss		≤ 0.03 dB	
Operating voltage		230 V AC ± 10 % 50 - 60 Hz	120 V AC ± 16 % 50 - 60 Hz
Control voltage		8 - 31 V DC	
Operating current		≤ 1.5 A	
Switching time		≤ 1.0 s	
Mechanical life (cycles)		≥ 250,000	
Ambient temperature		-10 °C ≤ θ ≤ +60 °C	
Weight		≈ 38.0 kg	

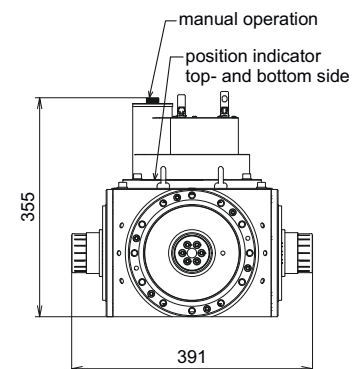

¹ For limitations see "Environmental Conditions for Broadcast Products".

Two-Way Switches DPDT with 8 3/16" EIA Connectors, Latching

- Motor drive
- Optical position indicator
- Manual operation
- Advanced interlock contacts
- End position signal contacts

Part Number		BN 941964	BN 941964C0110
Connectors		8 3/16" EIA	
Frequency range		0 - 620 MHz	
Proof voltage		≤ 24.0 kV	
Average power ¹	100 MHz 230 MHz 700 MHz	≤ 300 kW ≤ 200 kW ≤ 120 kW	
VSWR	100 MHz 230 MHz 700 MHz	≤ 1.06 ≤ 1.06 ≤ 1.08	
Isolation	100 MHz 230 MHz 700 MHz	≥ 75 dB ≥ 75 dB ≥ 70 dB	
Insertion loss		≤ 0.03 dB	
Operating voltage	230 V AC ± 10 % 50 - 60 Hz	120 V AC ± 16 % 50 - 60 Hz	
Control voltage		8 - 31 V DC	
Operating current		≤ 1.5 A	
Switching time		≤ 3.0 s	
Mechanical life (cycles)		≥ 100,000	
Ambient temperature		-10 °C ≤ θ ≤ +60 °C	
Weight		≈ 70.0 kg	

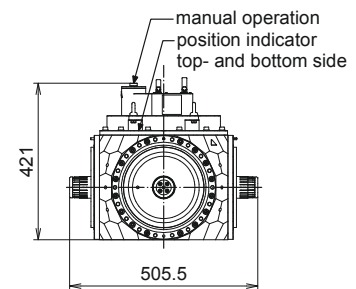

¹ For limitations see "Environmental Conditions for Broadcast Products".

Two-Way Plug-In Switches 1 5/8" USL-D for Patch Panels

- Motor drive
- Optical position indicator
- Manual operation
- Advanced interlock contacts
- Interlock protection in case of switch removal
- Twist protected on plug-in
- End position signal contacts
- Alternative operation with U-links possible

Part Number		BN 553064	BN 553065
Connectors		1 5/8" USL-D	
Frequency range		0 - 860 MHz	
Proof voltage		≤ 7.0 kV	
Average power ¹	100 MHz 230 MHz 700 MHz	≤ 20.0 kW ≤ 13.5 kW ≤ 7.0 kW	
VSWR	100 MHz 230 MHz 700 MHz	≤ 1.04	
Isolation	100 MHz 230 MHz 700 MHz	≥ 80 dB ≥ 80 dB ≥ 70 dB	
Insertion loss	860 MHz	≤ 0.1 dB	
Operating voltage		230 V AC ± 10 % 50 - 60 Hz	
Control voltage		8 - 31 V DC	230 V AC ± 10 % 50 - 60 Hz
Operating current		≤ 1.0 A	
Switching time		≤ 200 ms	
Mechanical life (cycles)		≥ 250,000	
Ambient temperature		-10 °C ≤ ϑ ≤ +45 °C	
Weight		≈ 5.0 kg	

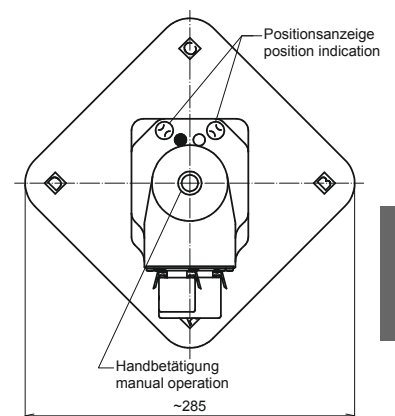
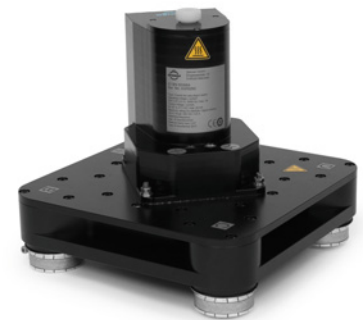

¹ For limitations see "Environmental Conditions for Broadcast Products".

Two-Way Plug-In Switches 29.5-68 USL-D for Patch Panels

- Motor drive
- Optical position indicator
- Manual operation
- Advanced interlock contacts
- Interlock protection in case of switch removal
- Twist protected on plug-in
- End position signal contacts
- Alternative operation with U-links possible

Part Number		BN 553364	BN 553365
Connectors		29.5-68 USL-D	
Frequency range		0 - 860 MHz	
Proof voltage		≤ 8.1 kV	
Average power ¹	100 MHz 230 MHz 700 MHz	≤ 41 kW ≤ 21 kW ≤ 14 kW	
VSWR	100 MHz 230 MHz 700 MHz	≤ 1.04	
Isolation	100 MHz 230 MHz 700 MHz	≥ 80 dB ≥ 80 dB ≥ 70 dB	
Insertion loss	860 MHz	≤ 0.1 dB	
Operating Voltage		230 V AC ± 10 % 50 - 60 Hz	
Control voltage		8 - 31 V DC	230 V AC ± 10 % 50 - 60 Hz
Operating current		≤ 1.0 A	
Switching time		≤ 200 ms	
Mechanical life (cycles)		≥ 250,000	
Ambient temperature		-10 °C ≤ θ ≤ +45 °C	
Weight		≈ 9.0 kg	

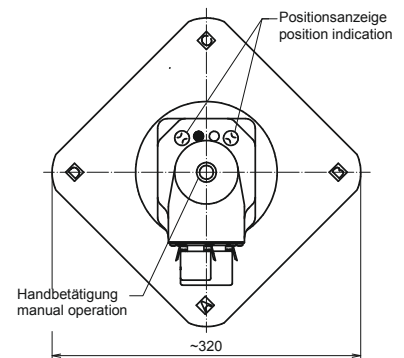

¹ For limitations see "Environmental Conditions for Broadcast Products".

Two-Way Plug-In Switches 43-98 USL-D for Patch Panels

- Motor drive
- Optical position indicator
- Manual operation
- Advanced interlock contacts
- Interlock protection in case of switch removal
- Twist protected on plug-in
- End position signal contacts
- Alternative operation with U-links possible

Part Number		BN 553664	BN 553665
Connectors		43-98 USL-D	
Frequency range		0 - 860 MHz	
Proof voltage		≤ 14.5 kV	
Average power ¹	100 MHz 230 MHz 700MHz	≤ 82 kW ≤ 42 kW ≤ 28 kW	
VSWR	100 MHz 230 MHz 700 MHz	≤ 1.04	
Isolation	100 MHz 230 MHz 700 MHz	≥ 80 dB ≥ 80 dB ≥ 60 dB	
Insertion loss		≤ 0.1 dB	
Operating voltage		230 V AC ± 10 % 50 - 60 Hz	
Control voltage		8 - 31 V DC	230 V AC ± 10 % 50 - 60 Hz
Operating current		≤ 1.0 A	
Switching time		≤ 500 ms	
Mechanical life (cycles)		≥ 250,000	
Ambient temperature		-10 °C ≤ ϑ ≤ +45 °C	
Weight		≈ 22.0 kg	

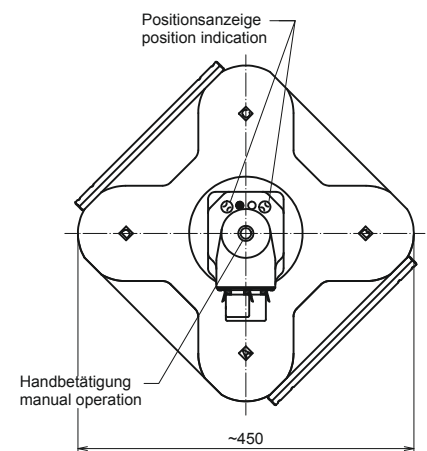

¹ For limitations see "Environmental Conditions for Broadcast Products".

Two-Way Switches DPDT, Low Intermodulation, Latching

- Impulse solenoid drive
- Optical position indicator
- Manual operation
- Advanced interlock contacts
- End position signal contacts

Part Number	BN 754081	BN 754082
Connectors	7-16 female	4.3-10 female
Frequency range	0.69 - 3.80 GHz	
Proof voltage	≤ 1.0 kV	
Average power ¹	0.69 - 3.80 GHz	≤ 300 W
VSWR	0.69 - 3.80 GHz	≤ 1.22
Isolation	0.69 - 2.69 GHz 3.40 - 3.80 GHz	≥ 55 dB ≥ 50 dB
Insertion loss	≤ 0.1 dB	
Intermodulation (IM3) @ 2 x 20 W, max./typ.	-165 dBc / -168 dBc	
Operating voltage	21.6 - 28.0 V DC	
Control voltage	U in low U in high	0 - 4.0 V DC 8.0 - 32.0 V DC
Operating current	≤ 1.1 A	
Switching time	≤ 100 ms	
Mechanical life (cycles)	≥ 500,000	
Ambient temperature	-10 °C ≤ ϑ ≤ +60 °C	
Weight	≈ 1.8 kg	

¹ For limitations see "Environmental Conditions for Broadcast Products".

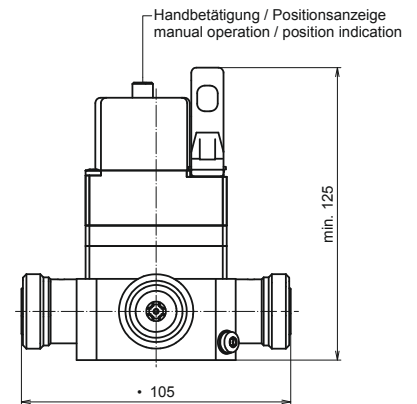

Two-Way Switches with N Connectors, 3 RF Planes, Failsafe

- Motor drive
- Optical position indicator
- Manual operation
- End position signal contacts

Part Number	BN 659038	
Connectors	N female	
Frequency range	0 - 2 GHz	
Proof voltage	≤ 3.0 kV	
Average power ¹	1 GHz 2 GHz	≤ 0.79 kW ≤ 0.56 kW
VSWR	1 GHz 2 GHz	≤ 1.02 ≤ 1.06
Isolation	1 GHz 2 GHz	≥ 90 dB ≥ 80 dB
Insertion loss	2 GHz	≤ 0.05 dB
Operating voltage	24 V DC ± 10 %	
Control voltage	24 V DC ± 10 %	
Operating current / holding current	≤ 2.5 A / 0.3 A	
Switching time	≤ 100 ms	
Mechanical life (cycles)	≥ 100,000	
Ambient temperature	-10 °C ≤ ϑ ≤ +45 °C	
Weight	≈ 2.7 kg	

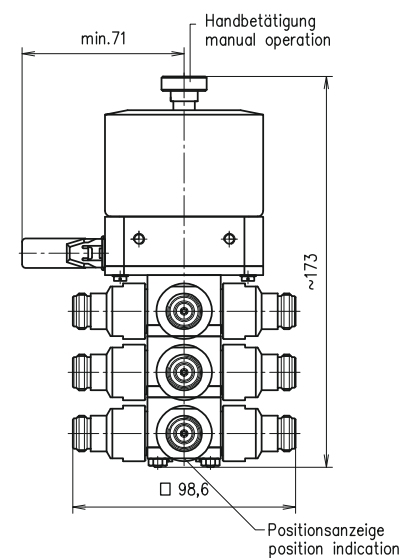

¹ For limitations see "Environmental Conditions for Broadcast Products".

Two-Way Switches With N Connectors, 3 RF Planes, Latching

- Motor drive
- Optical position indicator
- Manual operation
- End position signal contacts

Part Number		BN 512716
Connectors		N female
Frequency range		0 - 5 GHz
Proof voltage		≤ 3.0 kV
Average power ¹	1 GHz	≤ 0.79 kW
	2 GHz	≤ 0.56 kW
	3 GHz	≤ 0.45 kW
	5 GHz	≤ 0.35 kW
VSWR	1 GHz	≤ 1.03
	2 GHz	≤ 1.13
	3 GHz	≤ 1.13
	5 GHz	≤ 1.22
Isolation	1 GHz	≥ 75 dB
	2 GHz	≥ 60 dB
	3 GHz	≥ 60 dB
	5 GHz	≥ 50 dB
Insertion loss	2 GHz	≤ 0.04 dB
	5 GHz	≤ 0.06 dB
Operating voltage		26 V DC ± 15 %
Control voltage		26 V DC ± 15 %
Operating current		≤ 2.4 A
Switching time		≤ 100 ms
Mechanical life (cycles)		≥ 100,000
Ambient temperature		-10 °C ≤ ϑ ≤ +45 °C
Weight		≈ 2.0 kg

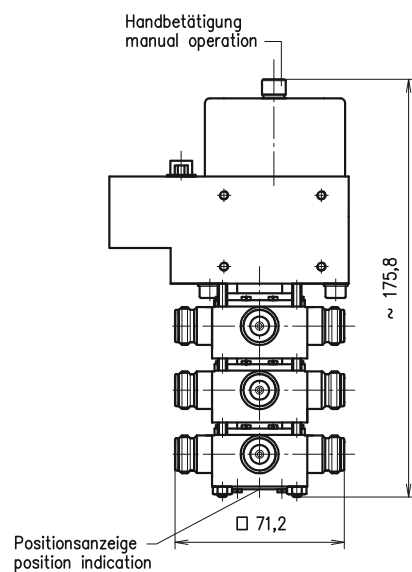

¹ For limitations see "Environmental Conditions for Broadcast Products".

N+1 Switching Units, Latching

- Replaces four 2-way switches
- Ready for operation
- Indication of the switching status at the front plate
- Modular expandable
- 19" drawer, 1 RU
- Easy installation with or without front plate

Part Number		BN 512663 (2+1) BN 512665 (4+1)
Connectors		N female
Frequency range		0 - 1.5 GHz
Proof voltage		≤ 1.0 kV
Average power ¹	100 MHz	≤ 280 W
	230 MHz	≤ 200 W
	860 MHz	≤ 130 W
	1500 MHz	≤ 75 W
VSWR	860 MHz	≤ 1.06 ² - ≤ 1.12 ³
	1500 MHz	≤ 1.20 ² - ≤ 1.22 ³
Isolation	860 MHz	≥ 45 dB
	1500 MHz	≥ 40 dB
Insertion loss	860 MHz	≤ 0.25 dB ² - ≤ 0.60 dB ³
	1500 MHz	≤ 0.35 dB ² - ≤ 0.70 dB ³
Operating voltage		10.8 - 26.4 V DC
Control voltage		8 - 28 V DC
Switching power		20 W
Switching time		≤ 100 ms
Switching characteristic		Bistable (latching)
Mechanical life (cycles)		≥ 100,000
Ambient temperature		-10 °C ≤ ϑ ≤ +45 °C
Weight		BN 512663 ≈ 3.5 kg BN 512665 ≈ 5.0 kg

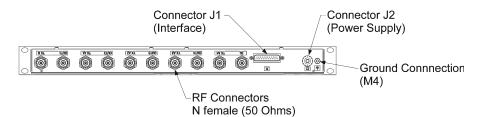
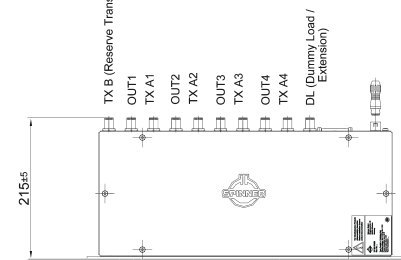
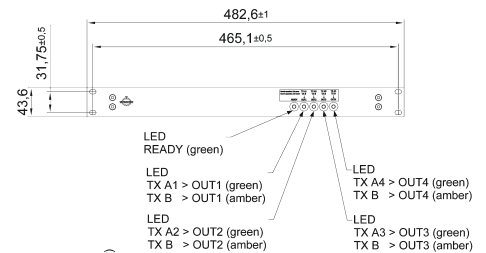

BN 512665

Coaxial Switches

¹ For limitations see "Environmental Conditions for Broadcast Products".
² Shortest path
³ Longest path

Rigid Lines and Cable Connectors



**SPINNER supplies three types of rigid line systems:
the EIA system, the SMS system and the flaring technique system (BT).**

The indicated technical data are also valid for rigid line elbows, which perform significantly better than the values established by the relevant international standards. The proof voltage values refer to sea level.

Rigid Lines and Cable Connectors

EIA System

Coaxial flange connectors, generally known as “EIA flanges”, are connected by a coupling element. The flange connector system complies with EIA STD RS-225, 339 IEC, DIN EN 122150 and MIL-F 24044. EIA flange connectors are excellently suited for pressurized systems and outdoor installations.

SMS System

The SPINNER quick clamping system, called “SMS”, complies with international rigid line standards including EIA STD RS 225, 339 IEC and DIN EN 122150.

Its parts are connected by coupling elements and secured by clamps. The major advantage of the SMS system is that customers can easily cut the rigid line to length on site without the need for flaring or brazing. Assembly is therefore very simple and requires no special tools.

The SMS system is only suitable for indoor use.

Flaring Technique System (BT)

The outer conductor tube is flared using a SPINNER flaring tool. Its parts are connected by coupling elements. The electrical contact at the outer conductor consists of a metallic ring mounted on the edge of the coupling elements’ insulation disk. The resulting very stable connection ensures high RF tightness and a repeatable electrical length.

The 52-120 BT flaring technique system is intended for indoor use and designed to handle RF power at levels up to 860 MHz. Please keep in mind that internal supports may be required, depending on the line length, to prevent the inner conductor from sagging.

Note:

For DVB or DAB operation, please note that the transmittable power is limited either by the proof voltage, taking the crest factor into account, or by the average power. When operating multiple transmitters, please base this on the sum of the individual proof voltages. The same thing applies to analog operating mode.

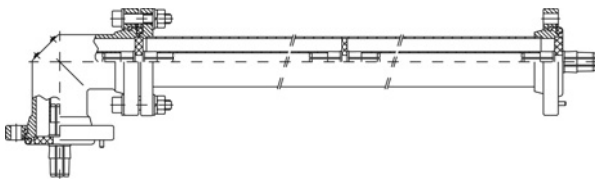

Example of assembly EIA

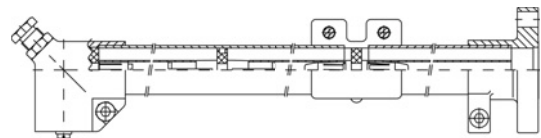

Example of assembly SMS

Rigid Line Components 7/8" EIA

- Very stable rigid line system
- Low insertion loss
- Low VSWR
- PTFE insulation
- Designed for pressure tight systems
- For outdoor application

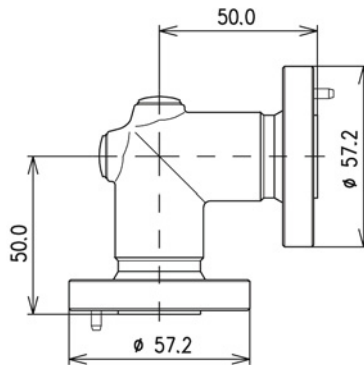

90° Elbow
BN 837105

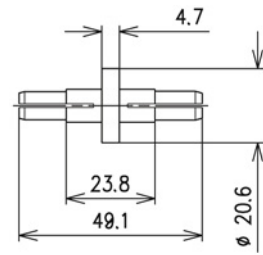

Coupling element
BN 911715

Components

	Length	Weight	Part Number
Inner conductor tube (copper)	L = 2 m L = 4 m	≈ 0.28 kg ≈ 0.57 kg	BN A02402 BN K20265C0004
Outer conductor tube (copper)	L = 2 m L = 4 m	≈ 1.35 kg ≈ 2.70 kg	BN A02403 BN K21751C0004
Rigid line (inner + outer conductor) with fixed flanges, custom-designed length Please define length in mm with your order. Spinner generates a part number extension for every specific length (V****).	0.075 m ≤ L ≤ 1 m 1 m < L ≤ 2 m 2 m < L ≤ 3 m		BN 874790V**** BN 874791V**** BN 874792V****
Inner support		≈ 0.01 kg	BN 542768
Fixed flange for brazing		≈ 0.17 kg	BN 006121
Coupling element incl. screw set		≈ 0.05 kg	BN 911715
90° Elbow		≈ 0.59 kg	BN 837105

Electrical Data

Impedance		50 Ω
Cut off frequency for H11-Mode		6.3 GHz
Proof voltage at sea level (NN)		3.8 kV
Frequency range		0 ≤ f ≤ 5.3 GHz
Average power at +40 °C ambient temperature	100 MHz 230 MHz 860 MHz	≤ 7.6 kW ≤ 5.0 kW ≤ 2.6 kW
Attenuation at +20 °C ambient temperature (dB/100m)	100 MHz 230 MHz 860 MHz	1.21 1.84 3.55

Rigid Line Components 7/8" EIA

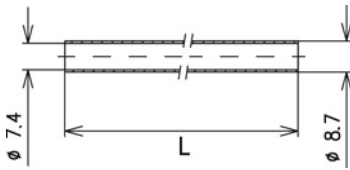

Inner conductor tube
BN A02402; BN K20265

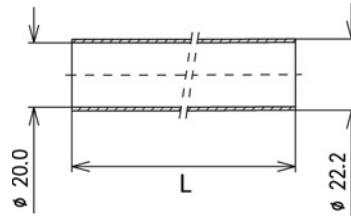

Outer conductor tube (not painted)
BN A02403; BN K21751

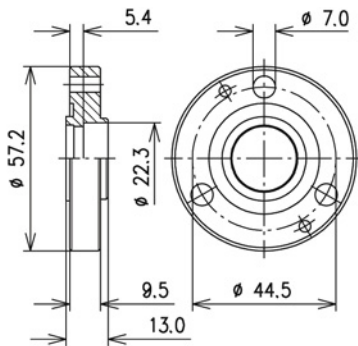

Fixed flange for brazing
BN 006121

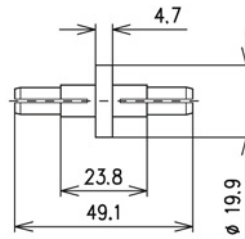

Inner support
BN 542768

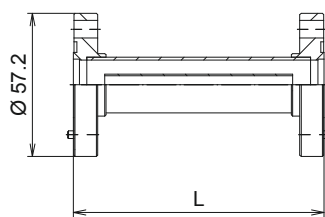

Rigid line
BN 874790V****

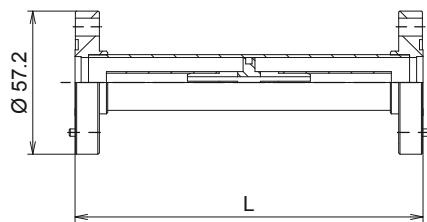

Rigid line
BN 874791V****

Length of rigid line L	Number inner supports required
1.0 m ≤ L ≤ 2.0 m	1
2.0 m < L ≤ 3.0 m	2
3.0 m < L ≤ 4.0 m	3

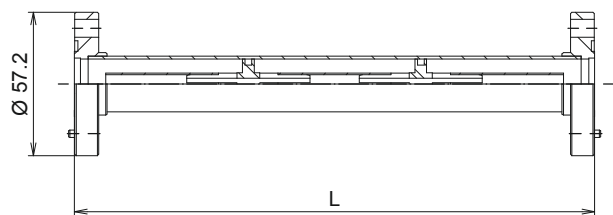

Rigid line
BN 874792V****

Rigid Line Components 1 5/8" EIA

- Very stable rigid line system
- Low insertion loss
- Low VSWR
- PTFE insulation
- Designed for pressure tight systems
- For outdoor application

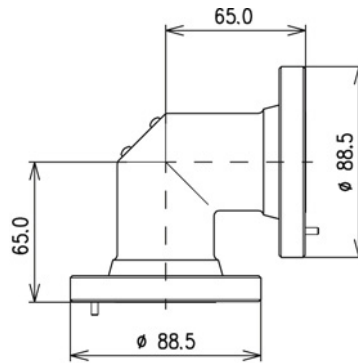

90° Elbow
BN 938520

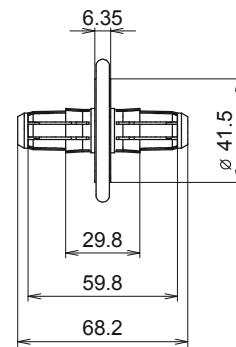

Coupling element
BN 918311

Components

	Length	Weight	Part Number
Inner conductor tube (copper)	L = 2 m L = 4 m	0.89 kg 1.78 kg	BN A02406 BN K19640C0004
Outer conductor tube (copper)	L = 2 m L = 4 m	2.78 kg 5.56 kg	BN A02407 BN K19608C0004
Rigid line (inner + outer conductor) with fixed flanges, custom-designed length Please define length in mm with your order. Spinner generates a part number extension for every specific length (V****).	0.09 m ≤ L ≤ 1.4 m 1.4 m < L ≤ 2.8 m 2.8 m < L ≤ 4 m		BN 859990V**** BN 859991V**** BN 859992V****
Inner support		≈ 0.04 kg	BN 859906
Fixed flange for brazing		≈ 0.42 kg	BN 006111
Coupling element incl. screw set		≈ 0.16 kg	BN 918311
90° Elbow		≈ 1.36 kg	BN 938520

Electrical Data

Impedance		50 Ω
Cut off frequency for H11-Mode		3.2 GHz
Proof voltage at sea level (NN)		7.0 kV
Frequency range		0 ≤ f ≤ 2.7 GHz
Average power at +40 °C ambient temperature	100 MHz 230 MHz 860 MHz	≤ 20.0 kW ≤ 13.5 kW ≤ 7.0 kW
Attenuation at +20 °C ambient temperature (dB/100m)	100 MHz 230 MHz 860 MHz	0.63 0.95 1.83

Rigid Line Components 1 5/8" EIA

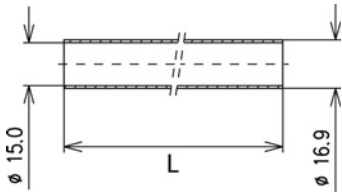

Inner conductor tube
BN A02406; BN K19640

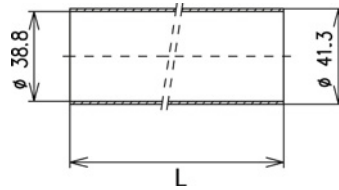

Outer conductor tube (not painted)
BN A02407; BN K19608

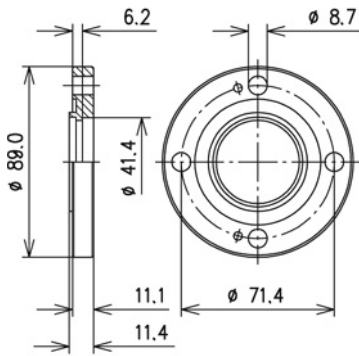

Fixed flange for brazing
BN 006111

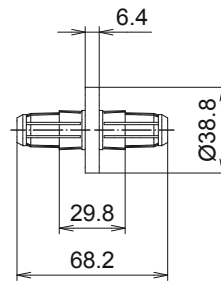

Inner support
BN 859906

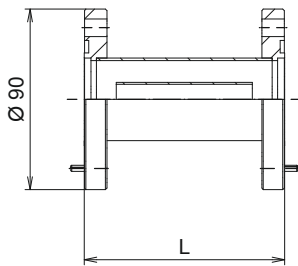

Rigid line
BN 859990V****

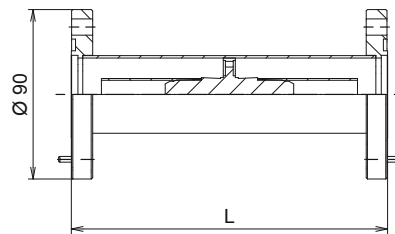

Rigid line
BN 859991V****

Length of rigid line L	Number inner supports required
$1.4 \text{ m} \leq L \leq 2.8 \text{ m}$	1
$2.8 \text{ m} < L \leq 4.0 \text{ m}$	2

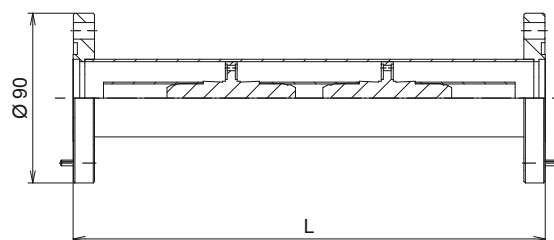

Rigid line
BN 859992V****

Rigid Line Components 3 1/8" EIA

- Very stable rigid line system
- Low insertion loss
- Low VSWR
- PTFE insulation
- Designed for pressure tight systems
- For outdoor application

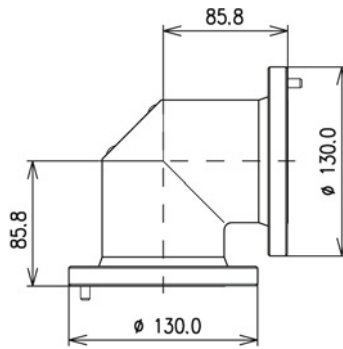

90° Elbow
BN 921920

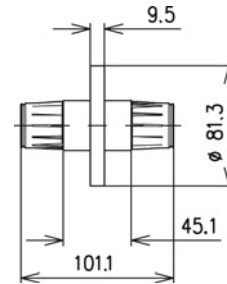

Coupling element
BN 918710

Components

	Length	Weight	Part Number
Inner conductor tube (copper)	L = 2 m L = 4 m	1.90 kg 3.80 kg	BN A02415 BN K22770C0004
Outer conductor tube (copper)	L = 2 m L = 4 m	5.90 kg 11.80 kg	BN A02416 BN K26569C0004
Rigid line (inner + outer conductor) with fixed flanges, custom-designed length Please define length in mm with your order. Spinner generates a part number extension for every specific length (V****).	0.92 m ≤ L ≤ 2 m 2 m < L ≤ 4 m		BN 870070V**** BN 870071V****
Inner support		0.27 kg	BN 870003
Fixed flange for brazing		0.75 kg	BN 004942
Coupling element incl. screw set		0.58 kg	BN 918710
90° Elbow		3.22 kg	BN 921920

Electrical Data

Impedance		50 Ω
Cut off frequency for H11-Mode		1.6 GHz
Proof voltage at sea level (NN)		14.0 kV
Frequency range		0 ≤ f ≤ 1.3 GHz
Average power at +40 °C ambient temperature	100 MHz 230 MHz 860 MHz	≤ 67.0 kW ≤ 44.0 kW ≤ 23.0 kW
Attenuation at +20 °C ambient temperature (dB/100m)	100 MHz 230 MHz 860 MHz	0.32 0.48 0.92

Rigid Line Components 3 1/8" EIA

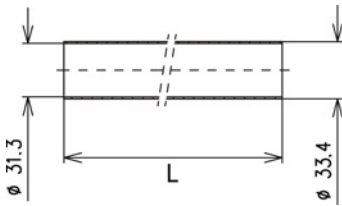

Inner conductor tube
BN A02415; BN K22770

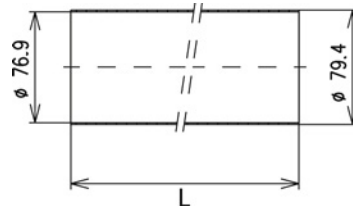

Outer conductor tube (not painted)
BN A02416; BN K26569

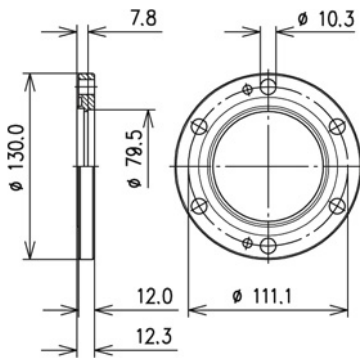

Fixed flange for brazing
BN 004942

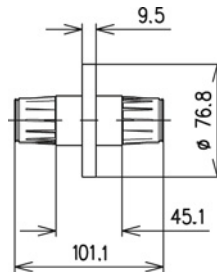

Inner support
BN 870003

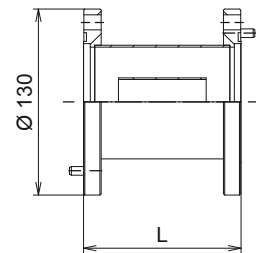

Rigid line
BN 870070V****

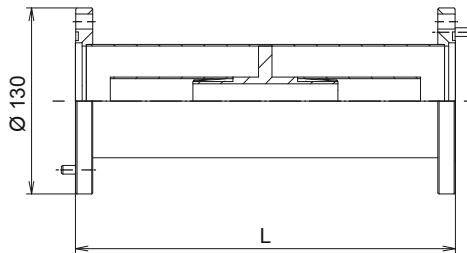

Rigid line
BN 870071V****

Length of rigid line L	Number inner supports required
$2.0 \text{ m} \leq L \leq 4.0 \text{ m}$	1

Rigid Line Components 4 1/2" EIA ¹

- Very stable rigid line system
- Low insertion loss
- Low VSWR
- PTFE insulation
- Designed for pressure tight systems
- For outdoor application

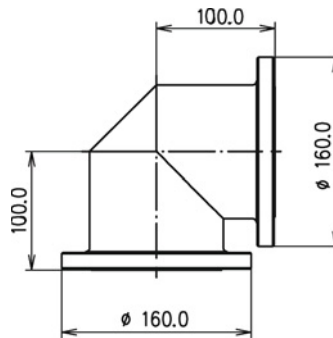

90° Elbow
BN 704001

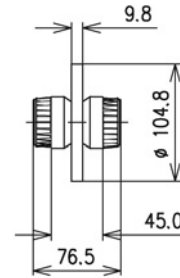

Coupling element
BN 822810

Components

	Length	Weight	Part Number
Inner conductor tube (copper)	L = 2 m L = 4 m	2.50 kg 5.00 kg	BN A02421 BN K26291C0004
Outer conductor tube (copper)	L = 2 m L = 4 m	8.80 kg 17.60 kg	BN A02422 BN K20852C0004
Rigid line (inner + outer conductor) with fixed flanges, custom-designed length Please define length in mm with your order. Spinner generates a part number extension for every specific length (V****).	0.12 m ≤ L ≤ 2.5 m 2.5 m < L ≤ 4 m		BN 648614V**** BN 648681V****
Inner support		0.60 kg	BN 648602
Fixed flange for brazing		1.29 kg	BN 648601
Coupling element incl. screw set		1.07 kg	BN 822810
90° Elbow		6.10 kg	BN 704001

Electrical Data

Impedance		50 Ω
Cut off frequency for H11-Mode		1.2 GHz
Proof voltage at sea level (NN)		19.0 kV
Frequency range		0 ≤ f ≤ 1.0 GHz
Average power at +40 °C ambient temperature	100 MHz 230 MHz 860 MHz	≤ 112.0 kW ≤ 74.0 kW ≤ 38.0 kW
Attenuation at +20 °C ambient temperature (dB/100m)	100 MHz 230 MHz 860 MHz	0.24 0.36 0.69

¹ 339 IEC 50-105

Rigid Line Components 4 1/2" EIA ¹

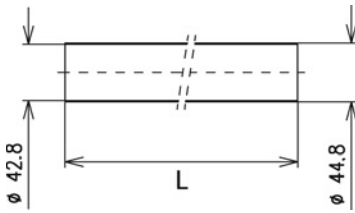

Inner conductor tube
BN A02421; BN K26291

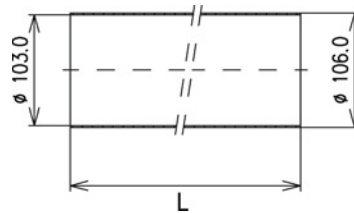

Outer conductor tube (not painted)
BN A02422; BN K20852

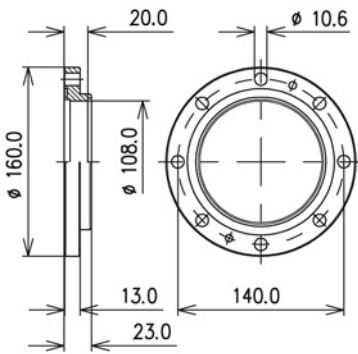

Fixed flange for brazing
BN 648601

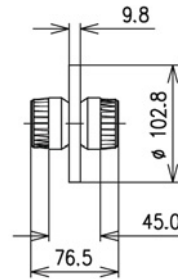

Inner support
BN 648602

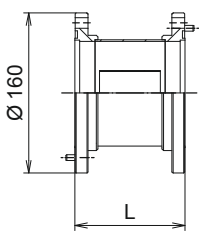

Rigid line
BN 648614V****

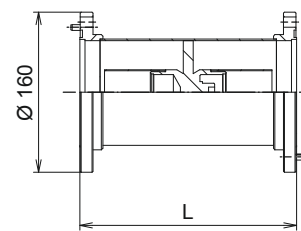

Rigid line
BN 648681V****

Length of rigid line L	Number inner supports required
2.5 m ≤ L ≤ 4.0 m	1

¹ 339 IEC 50-105

Rigid Line Components 6 1/8" EIA

- Very stable rigid line system
- Low insertion loss
- Low VSWR
- PTFE insulation
- Designed for pressure tight systems
- For outdoor application

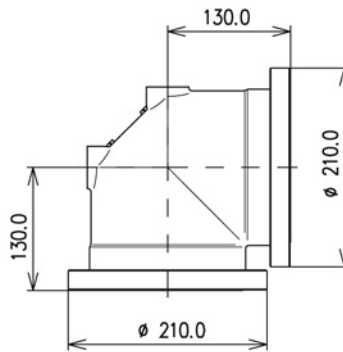

90° Elbow
BN 873208

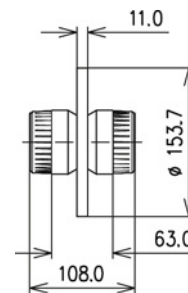

Coupling element
BN 919310

Components

	Length	Weight	Part Number
Inner conductor tube (copper)	L = 2 m L = 4 m	3.52 kg 7.04 kg	BN A02427 BN K23334C0004
Outer conductor tube (copper)	L = 2 m L = 4 m	15.81 kg 31.62 kg	BN A02428 BN K26568C0004
Rigid line (inner + outer conductor) with fixed flanges, custom-designed length Please define length in mm with your order. Spinner generates a part number extension for every specific length (V****).	0.15 m ≤ L ≤ 3 m 3 m < L ≤ 4 m		BN 873170V**** BN 873141V****
Inner support		2.45 kg	BN 532784
Fixed flange for brazing		1.75 kg	BN 008550
Coupling element incl. screw set		2.12 kg	BN 919310
90° Elbow		6.66 kg	BN 873208

Electrical Data

Impedance		50 Ω
Cut off frequency for H11-Mode		830 MHz
Proof voltage at sea level (NN)		28.0 kV
Frequency range		0 ≤ f ≤ 800 MHz
Average power at +40 °C ambient temperature	100 MHz 230 MHz 800 MHz	≤ 224.0 kW ≤ 148.0 kW ≤ 78.0 kW
Attenuation at +20 °C ambient temperature (dB/100m)	100 MHz 230 MHz 800 MHz	0.16 0.24 0.46

Rigid Line Components 6 1/8" EIA

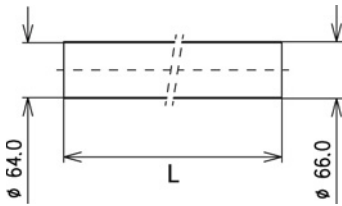

Inner conductor tube
BN A02427; BN K23334

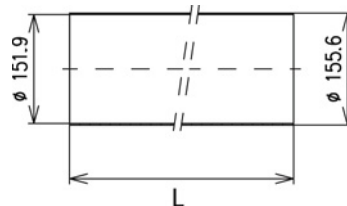

Outer conductor tube (not painted)
BN A02428; BN K26568

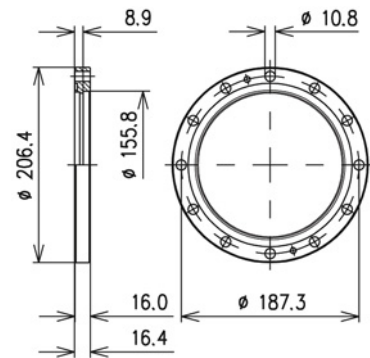

Fixed flange for brazing
BN 008550

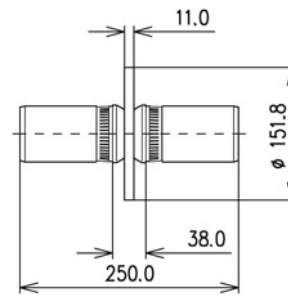

Inner support
BN 532784

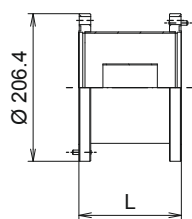

Rigid line
BN 873170V****

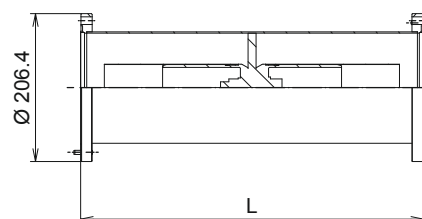

Rigid line
BN 873141V****

Length of rigid line L	Number inner supports required
$3.0\text{ m} \leq L \leq 4.0\text{ m}$	1

Rigid Lines & Cable Connectors

Rigid Line Components 7/8" SMS

- Outer conductor system without contact ring in copper/ copper alloy
- Quick and simple assembly
- No special tools required
- PTFE insulation
- For indoor application

Components

	Length	Weight	Part Number
Inner conductor tube (copper)	L = 2 m L = 4 m	0.28 kg 0.57 kg	BN A02402 BN K20265C0004
Outer conductor tube (copper)	L = 2 m L = 4 m	1.35 kg 2.70 kg	BN A02403 BN K21751C0004
Inner support		0.01 kg	BN 542768
Adapter SMS clamp to 7/8" EIA		0.23 kg	BN 542767
Adapter SMS clamp to 7-16 female		0.15 kg	BN 542779
Coupling element for 7/8" EIA incl. screw set		0.05 kg	BN 911715
Rigid line splice		0.11 kg	BN 542769
90° Elbow		0.16 kg	BN 542762

Electrical Data

Impedance		50 Ω
Cut off frequency for H11-Mode		6.3 GHz
Proof voltage at sea level (NN)		3.8 kV
Frequency range		$0 \leq f \leq 5.3$ GHz
Average power at +40 °C ambient temperature	100 MHz 230 MHz 800 MHz	≤ 7.6 kW ≤ 5.0 kW ≤ 2.6 kW
Attenuation at +20 °C ambient temperature (dB/100m)	100 MHz 230 MHz 800 MHz	1.21 1.84 3.55
Installation instruction		M 36123

Rigid Line Components 7/8" SMS

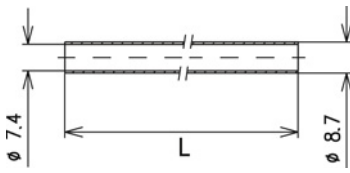

Inner conductor tube
BN A02402; BN K20265

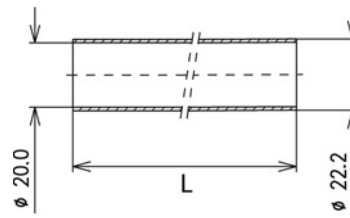

Outer conductor tube (not painted)#
BN A02403; BN K21751

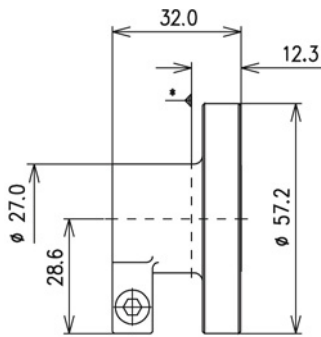

Adapter SMS clamp to 7/8" EIA
BN 542767

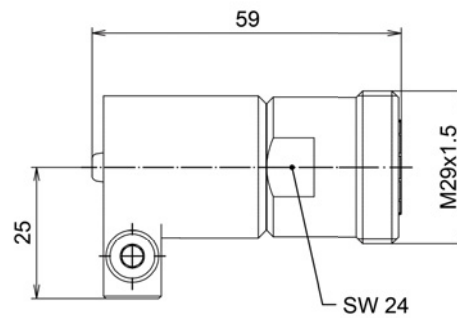

Adapter SMS clamp to 7-16 female
BN 542779

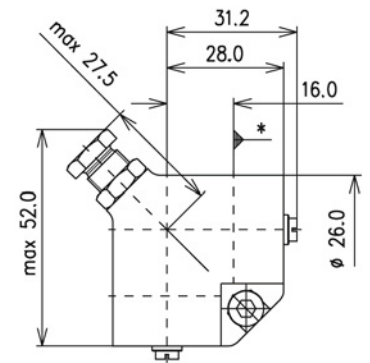

90° Elbow with adjustment screw
BN 542762

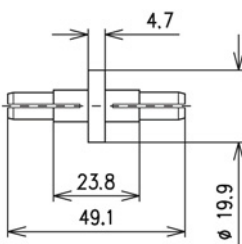

Inner support
BN 542768

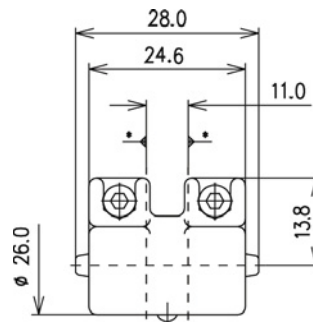

Rigid line splice
BN 542769

Length of rigid line L	Number inner supports required
1.0 m ≤ L ≤ 2.0 m	1
2.0 m < L ≤ 3.0 m	2
3.0 m < L ≤ 4.0 m	3

* Reference plane

Rigid Line Components 1 5/8" SMS-1

- Outer conductor system aluminium/aluminium alloy
- Quick and simple assembly
- No special tools required
- PTFE insulation
- For indoor application

Components

	Length	Weight	Part Number
Inner conductor tube (copper)	L = 2 m L = 4 m	0.89 kg 1.78 kg	BN A02406 BN K19640C0004
Outer conductor tube (aluminium)	L = 2 m L = 4 m	0.86 kg 1.72 kg	BN A02409 BN K20201C0004
Inner support		0.04 kg	BN 859906
Adapter SMS-1 clamp to 1 5/8" EIA		0.21 kg	BN B13487C1000
Coupling element for 1 5/8" EIA incl. screw set		0.16 kg	BN 918311
Rigid line splice		0.29 kg	BN 532704
90° Elbow		0.29 kg	BN 532702

Electrical Data

Impedance		50 Ω
Cut off frequency for H11-Mode		3.2 GHz
Proof voltage at sea level (NN)		7.0 kV
Frequency range		$0 \leq f \leq 2.7$ GHz
Average power at +40 °C ambient temperature	100 MHz 230 MHz 800 MHz	≤ 19.6 kW ≤ 13.0 kW ≤ 7.0 kW
Attenuation at +20 °C ambient temperature (dB/100m)	100 MHz 230 MHz 800 MHz	0.75 1.13 2.19
Installation instruction		M 36124

Rigid Line Components 1 5/8" SMS-2

- Outer conductor system without contact ring, in copper/ copper alloy
- Quick and simple assembly
- No special tools required
- PTFE insulation
- For indoor application

Components

	Length	Weight	Part Number
Inner conductor tube (copper)	L = 2 m L = 4 m	0.90 kg 1.80 kg	BN A02406 BN K19640C0004
Outer conductor tube (copper)	L = 2 m L = 4 m	2.80 kg 5.60 kg	BN A02407 BN K19608C0004
Inner support		0.04 kg	BN 859906
Adapter SMS-1 clamp to 1 5/8" EIA		0.21 kg	BN B13487C1000
Coupling element for 1 5/8" EIA incl. screw set		0.16 kg	BN 918311
Rigid line splice		0.46 kg	BN 542749
90° Elbow		0.66 kg	BN 542742

Electrical Data

Impedance		50 Ω
Cut off frequency for H11-Mode		3.2 GHz
Proof voltage at sea level (NN)		7.0 kV
Frequency range		$0 \leq f \leq 2.7$ GHz
Average power at +40 °C ambient temperature	100 MHz 230 MHz 860 MHz	≤ 20.0 kW ≤ 13.5 kW ≤ 7.0 kW
Attenuation at +20 °C ambient temperature (dB/100m)	100 MHz 230 MHz 860 MHz	0.63 0.95 1.83
Installation instruction		M 36129

Rigid Line Components 1 5/8" SMS-2

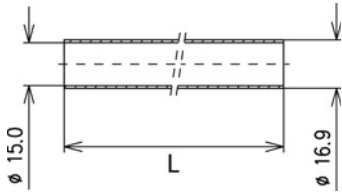

Inner conductor tube
BN A02406; BN K19640

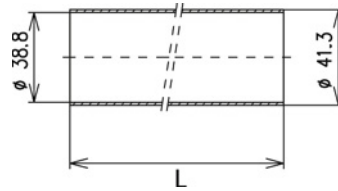

Outer conductor tube (not painted)
BN A02407; BN K19608

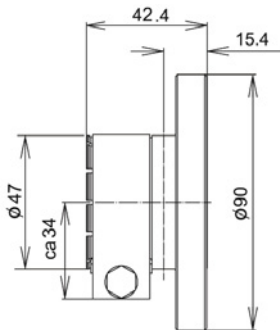

Adapter SMS-2 clamp to 1 5/8" EIA
BN B13487C1000

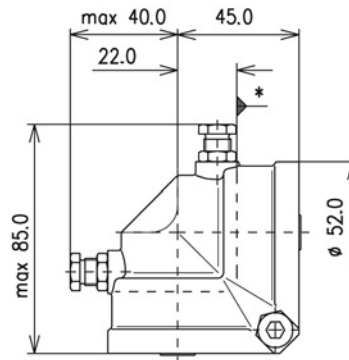

90° Elbow with adjustment screws
BN 542742

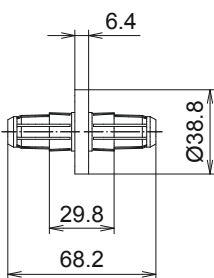

Inner support
BN 859906

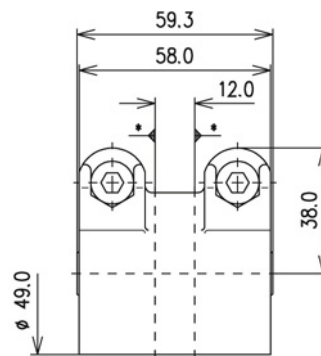

Rigid line splice
BN 542749

Length of rigid line L	Number inner supports required
1.4 m \leq L \leq 2.8 m	1
2.8 m $<$ L \leq 4.0 m	2

* Reference plane

Rigid Line Components 3 1/8" SMS

- Outer conductor system aluminium/aluminium alloy
- Quick and simple assembly
- No special tools required
- PTFE insulation
- For indoor application

Components

	Length	Weight	Part Number
Inner conductor tube (copper)	L = 2 m L = 4 m	1.90 kg 3.80 kg	BN A02415 BN K22770C0004
Outer conductor tube (aluminium)	L = 2 m L = 4 m	1.70 kg 3.40 kg	BN A02417 BN K20202C0004
Inner support		0.27 kg	BN 870003
Adapter SMS clamp to 3 1/8" EIA		0.40 kg	BN B10865C1000
Coupling element for 3 1/8" EIA incl. screw set		0.58 kg	BN 918710
Rigid line splice		0.64 kg	BN 532721
90° Elbow		1.32 kg	BN 532723

Electrical Data

Impedance		50 Ω
Cut off frequency for H11-Mode		1.6 GHz
Proof voltage at sea level (NN)		14.0 kV
Frequency range		$0 \leq f \leq 1.3$ GHz
Average power at +40 °C ambient temperature	100 MHz 230 MHz 860 MHz	≤ 63.0 kW ≤ 42.0 kW ≤ 22.0 kW
Attenuation at +20 °C ambient temperature (dB/100m)	100 MHz 230 MHz 860 MHz	0.37 0.56 1.08
Installation instruction		M 36125

Rigid Line Components 3 1/8" SMS

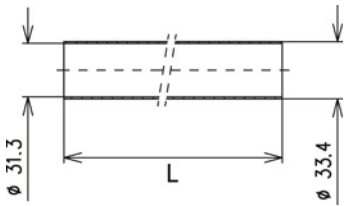

Inner conductor tube
BN A02415; BN K22770

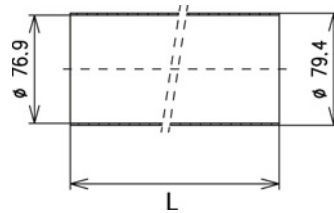

Outer conductor tube (not painted)
BN A02417; BN K20202

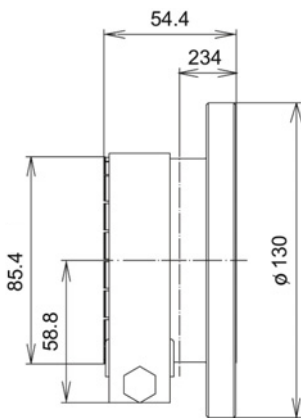

Adapter SMS clamp to 3 1/8" EIA
BN B10865C1000

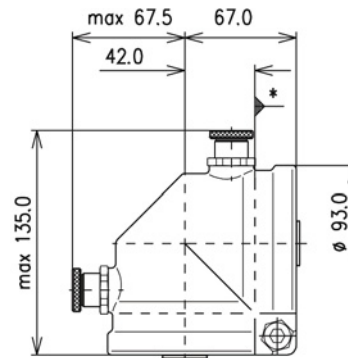

90° Elbow with adjustment screws
BN 532723

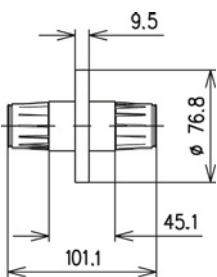

Inner support
BN 870003

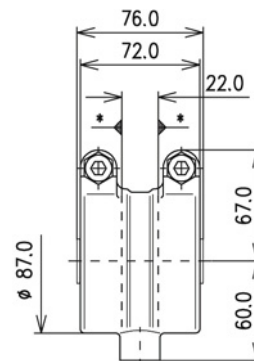

Rigid line splice
BN 532721

Length of rigid line L	Number inner supports required
2.0 m ≤ L ≤ 4.0 m	1

* Reference plane

Rigid Line Components 4 1/2" SMS

- Outer conductor system aluminium/aluminium alloy
- Quick and simple assembly
- No special tools required
- PTFE insulation
- For indoor application

Components

	Length	Weight	Part Number
Inner conductor tube (copper)	L = 2 m L = 4 m	2.50 kg 5.00 kg	BN A02421 BN K26291C0004
Outer conductor tube (aluminium)	L = 2 m L = 4 m	2.70 kg 5.40 kg	BN A02423 BN K20203C0004
Inner support		0.60 kg	BN 648602
Adapter SMS clamp to 4 1/2" EIA (339 IEC 50-105)		0.93 kg	BN 532766
Coupling element for 4 1/2" EIA (339 IEC 50-105) incl. screw set		1.07 kg	BN 822810
Rigid line splice		2.02 kg	BN 532763
90° Elbow		3.72 kg	BN 532761

Electrical Data

Impedance		50 Ω
Cut off frequency for H11-Mode		1.2 GHz
Proof voltage at sea level (NN)		19.0 kV
Frequency range		$0 \leq f \leq 1.0$ GHz
Average power at +40 °C ambient temperature	100 MHz 230 MHz 860 MHz	≤ 106.0 kW ≤ 70.0 kW ≤ 37.0 kW
Attenuation at +20 °C ambient temperature (dB/100m)	100 MHz 230 MHz 860 MHz	0.28 0.42 0.82
Installation instruction		M 36126

Rigid Line Components 4 1/2" SMS

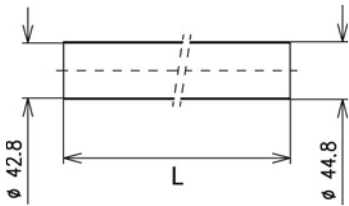

Inner conductor tube
BN A02421; BN K26291

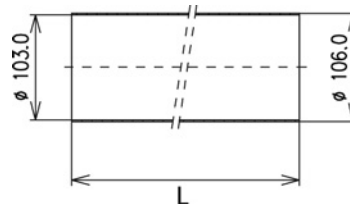

Outer conductor tube (not painted)
BN A02423; BN K20203

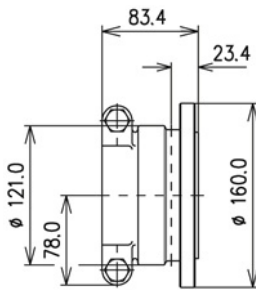

Adapter SMS clamp to 4 1/2" EIA¹
BN 532766

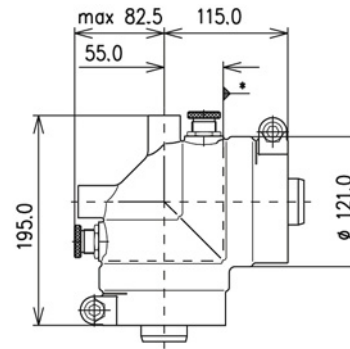

90° Elbow with adjustment screws
BN 532761

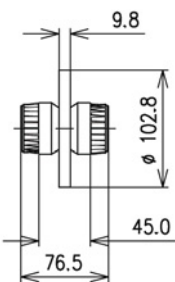

Inner support
BN 648602

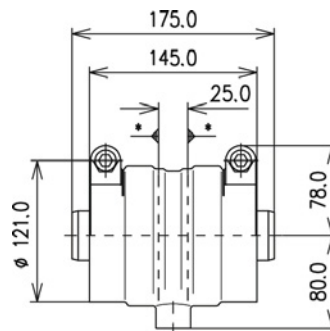

Rigid line splice
BN 532763

Length of rigid line L	Number inner supports required
2.5 m ≤ L ≤ 4.0 m	1

¹ 339 IEC 50-105

* Reference plane

Rigid Line Components 52-120 SMS

- Outer conductor system aluminium/aluminium alloy
- Quick and simple assembly
- No special tools required
- PTFE insulation
- For indoor application

Components

	Length	Weight	Part Number
Inner conductor tube (copper)	L = 2 m	2.90 kg	BN A02424
	L = 4 m	5.80 kg	BN K24058C0004
Outer conductor tube (aluminium)	L = 2 m	3.20 kg	BN A02426
	L = 4 m	6.40 kg	BN K20206C0004
Inner support		1.78 kg	BN 542705
Adapter SMS clamp to 4 1/2" EIA (339 IEC 50-105)		6.78 kg	BN 542720C0001
Coupling element for 4 1/2" EIA (339 IEC 50-105) incl. screw set		1.07 kg	BN 822810
Adapter SMS clamp to 6 1/8" EIA		9.50 kg	BN 542701
Coupling element for 6 1/8" EIA incl. screw set		2.12 kg	BN 919310
Adapter SMS clamp to 52-120 BT		0.90 kg	BN 542726
Coupling element 52-120 BT incl. screw set		1.31 kg	BN 528101
Rigid line splice		3.34 kg	BN 542704
90° Elbow		5.22 kg	BN 542702

Electrical Data

Impedance		50 Ω
Cut off frequency for H11-Mode		1.0 GHz
Proof voltage at sea level (NN)		22.0 kV
Frequency range		$0 \leq f \leq 890$ MHz
Average power at +40 °C ambient temperature	100 MHz 230 MHz 860 MHz	≤ 140.0 kW ≤ 92.0 kW ≤ 47.0 kW (≤ 57.0 kW) ¹
Attenuation at +20 °C ambient temperature (dB/100m)	100 MHz 230 MHz 860 MHz	0.24 0.36 0.69
Installation instruction		M 36127

¹ In this case it is necessary to paint the rigid line with a black, heat resistant varnish

Rigid Line Components 52-120 SMS

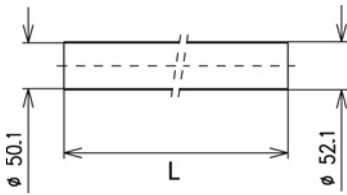

Inner conductor tube
BN A02424; BN K24058

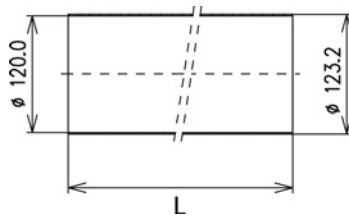

Outer conductor tube (not painted)
BN A02426; BN K20206

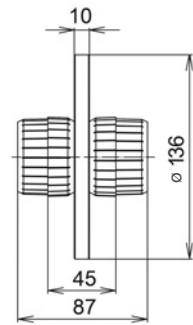

Coupling element 52-120 BT incl. screw set
BN 528101

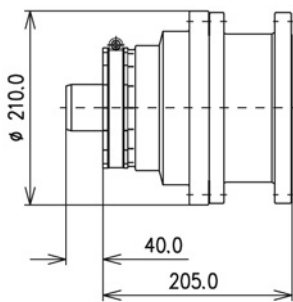

Adapter SMS clamp to 6 1/8" EIA
BN 542701

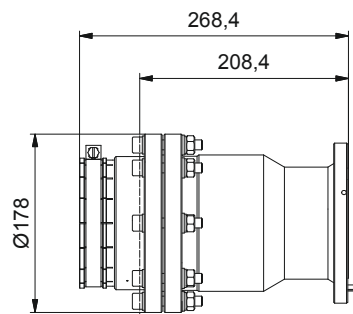

Adapter SMS clamp to 4 1/2" EIA¹
BN 542720C0001

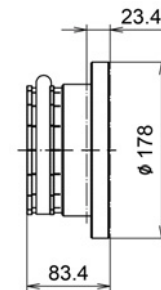

Adapter SMS clamp to 52-120 BT
BN 542726

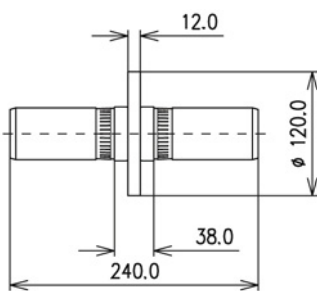

Inner support
BN 542705

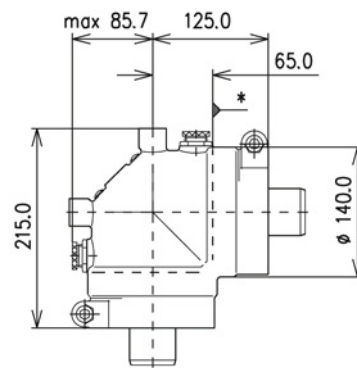

90° Elbow with adjustment screws
BN 542702

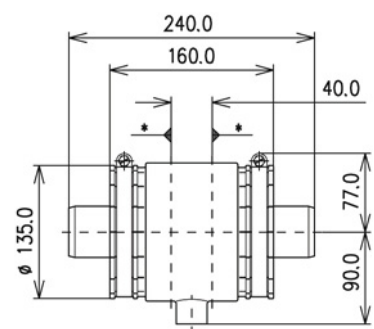

Rigid line splice
BN 542704

Length of rigid line L	Number inner supports required
3.0 m ≤ L ≤ 4.0 m	1

¹ 339 IEC 50-105

* Reference plane

Rigid Line Components 52-120 BT

- Outer conductor system copper/copper alloy
- Easy assembly
- SPINNER flaring tool BN 511400 with Insert BN 511445 available
- PTFE insulation
- For indoor application

Components

	Length	Weight	Part Number
Inner conductor tube (copper)	L = 2 m L = 4 m	2.90 kg 5.80 kg	BN A02424 BN K24058C0004
Outer conductor tube (copper)	L = 2 m L = 4 m	10.21 kg 20.42 kg	BN A02425 BN K33221C0004
Inner support		1.78 kg	BN 542705
Flange		1.72 kg	BN 049917S012
Coupling element 52-120 BT including screw set		1.31 kg	BN 528101
90° Elbow		8.52 kg	BN 528165
Adapter 52-120 BT (without coupling element) to 4 1/2" EIA (339 IEC 50-105)		4.06 kg	BN 528118
Coupling element for 4 1/2" EIA (339 IEC 50-105) incl. screw set		1.07 kg	BN 822810
Adapter 52-120 BT (without coupling element) to 6 1/8" EIA		5.30 kg	BN 528117
Coupling element for 6 1/8" EIA incl. screw set		2.12 kg	BN 919310

Electrical Data

Impedance		50 Ω
Cut off frequency for H11-Mode		1.0 GHz
Proof voltage at sea level (NN)		22.0 kV
Frequency range		0 ≤ f ≤ 860 MHz
Average power at +40 °C ambient temperature	100 MHz 230 MHz 860 MHz	≤ 142.0 kW ≤ 93.0 kW ≤ 48.0 kW (≤ 60.0 kW) ¹
Attenuation at +20 °C ambient temperature (dB/100m)	100 MHz 230 MHz 860 MHz	0.22 0.33 0.63

¹ In this case it is necessary to paint the rigid line with a black, heat resistant varnish

Rigid Line Components 52-120 BT

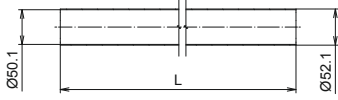

Inner conductor tube
BN A02424; BN K24058

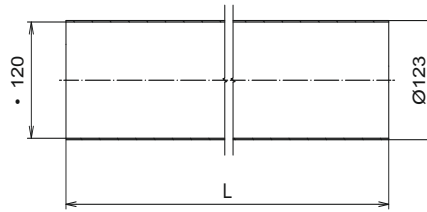

Outer conductor tube (not painted)
BN A02425; BN K33221

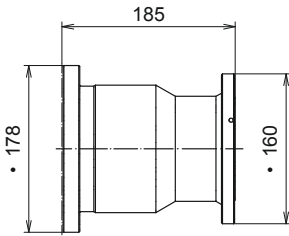

Adapter 52-120 BT to 4 1/2" EIA¹
BN 528118

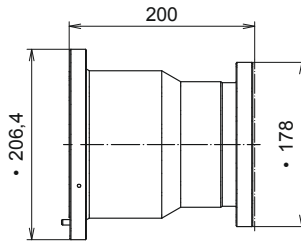

Adapter 52-120 BT to 6 1/8" EIA
BN 528117

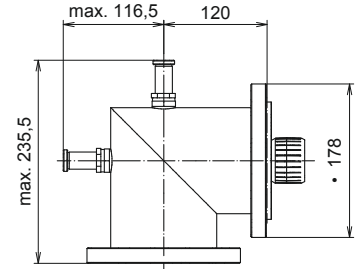

90° Elbow with adjustment screws
BN 528165

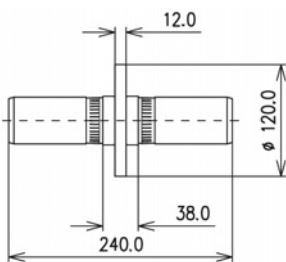

Inner support
BN 542705

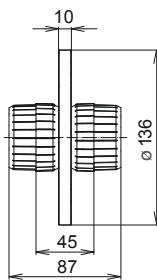

Coupling element, including screw set
BN 528101

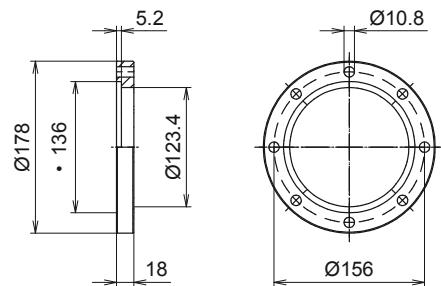

Flange, nickel plated
BN 049917S012

Length of rigid line L	Number inner supports required
3.0 m ≤ L ≤ 4.0 m	1

¹ 339 IEC 50-105

Rigid Lines & Cable
 Connectors

Rigid Line Components 6 1/8" SMS

- Outer conductor system aluminium/aluminium alloy
- Quick and simple assembly
- No special tools required
- PTFE insulation
- For indoor application

Components

	Length	Weight	Part Number
Inner conductor tube (copper)	L = 2 m L = 4 m	3.50 kg 7.00 kg	BN A02427 BN K23334C0004
Outer conductor tube (aluminium)	L = 2 m L = 4 m	5.50 kg 11.00 kg	BN A02429 BN K20204C0004
Inner support		2.45 kg	BN 532784
Adapter SMS clamp to 4 1/2" EIA (339 IEC 50-105)		1.28 kg	BN 532789
Coupling element for 4 1/2" EIA (339 IEC 50-105) incl. screw set		2.12 kg	BN 919310
Rigid line splice		3.44 kg	BN 532783
90° Elbow		3.70 kg	BN 532781

Electrical Data

Impedance		50 Ω
Cut off frequency for H11-Mode		0.83 GHz
Proof voltage at sea level (NN)		28.0 kV
Frequency range		$0 \leq f \leq 800$ MHz
Average power at +40 °C ambient temperature	100 MHz 230 MHz 800 MHz	≤ 213.0 kW ≤ 140.0 kW ≤ 72.0 kW
Attenuation at +20 °C ambient temperature (dB/100m)	100 MHz 230 MHz 800 MHz	0.19 0.28 0.54
Installation instruction		M 36128

Rigid Line Components 6 1/8" SMS

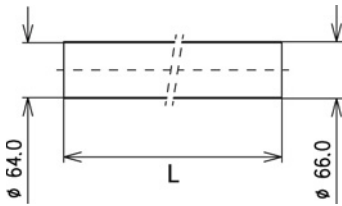

Inner conductor tube
BN A02427; BN K23334

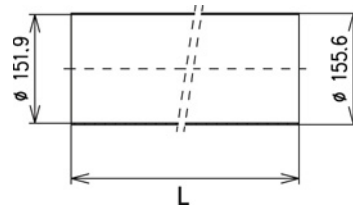

Outer conductor tube (not painted)
BN A02429; BN K20204

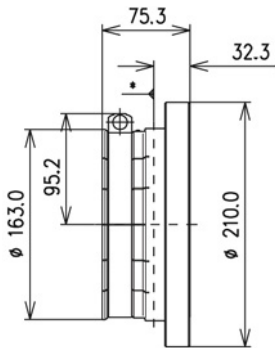

Adapter SMS clamp to 6 1/8" EIA
BN 532789

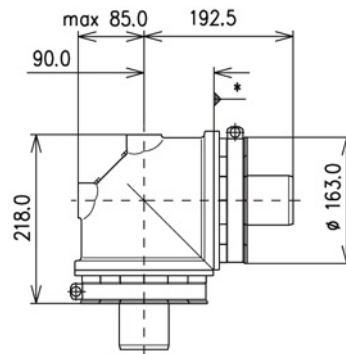

90° Elbow with adjustment screw
BN 532781

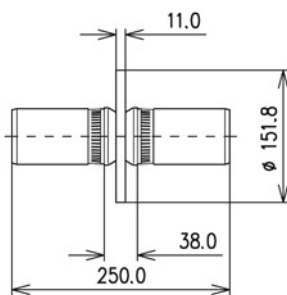

Inner support
BN 532784

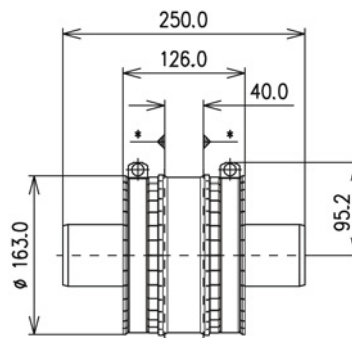

Rigid line splice
BN 532783

Length of rigid line L	Number inner supports required
$3.0 \text{ m} \leq L \leq 4.0 \text{ m}$	1

* Reference plane



Cable Connectors and Accessories

SPINNER carries N, 4.3-10, 7-16, 7/8" EIA, 1 5/8" EIA, 3 1/8" EIA, 4 1/2" EIA (339 IEC 50-105) and 6 1/8" EIA connectors for cables made by leading manufacturers. They are famous for their superior RF performance and reliability going back over 60 years:

- CAF® design for ultrafast installation: simply push the stripped cable end into the connector.
- Premium design with flared inner and outer contacts for maximum reliability at high RF power levels
- Connectors for air dielectric cables are tight (the barrier and mating are face-sealed) and have inlets for pressurization.
- There is no risk of water ingress and corrosion, since the gap between the outer conductor and the connector is sealed with Plast 2000 or a custom-shaped gasket.

SPINNER connectors comply with international standards EIA STD RS-225, IEC 60339, MIL-F 24044 and IEC 60169-4/-5.

SPINNER supplies various adapters in test quality.

SPINNER supplies special tools for speeding installation and improving reliability.

The maximum permissible power depends on the frequency, modulation, reflection and environmental conditions.

The chart shows the maximum CW power for which the EIA connectors are suitable under ideal conditions (no reflection and an ambient temperature of 40°C).

The power rating can be limited by the connector or cable, whichever is lower.

It is advisable to ensure a reasonable safety margin.

Maximum Power Rating

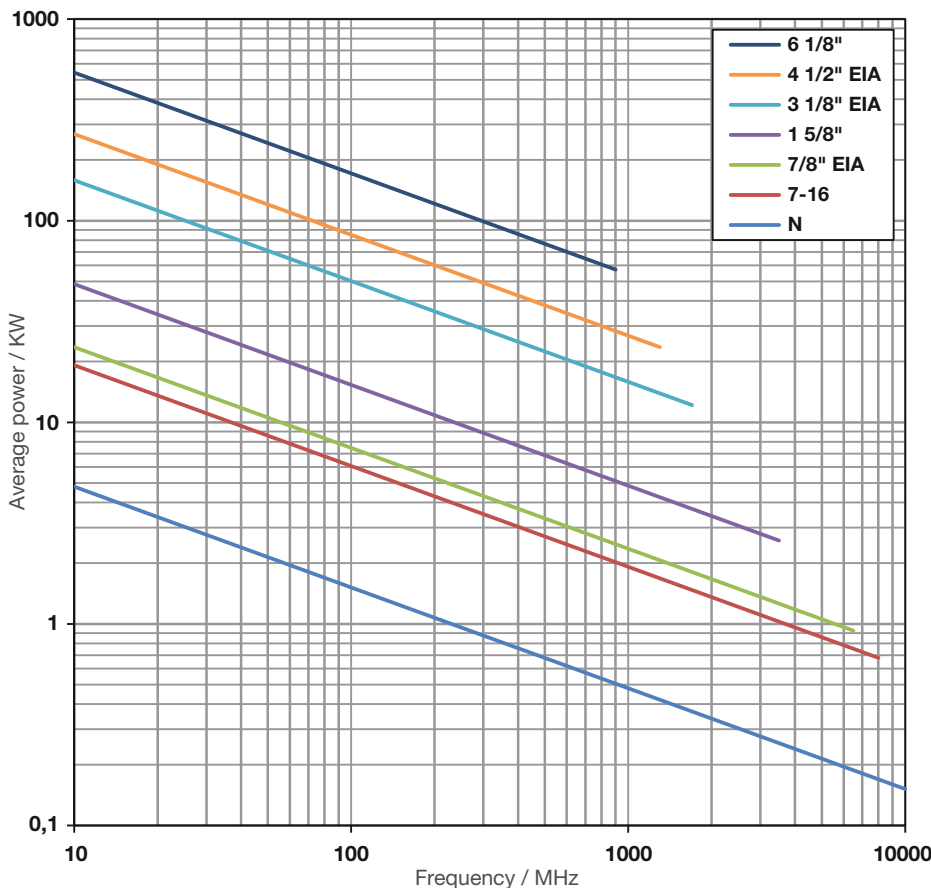

339 IEC 50-105

All power ratings apply to an ambient temperature of +40 °C ambient temperature and an inner conductor temperature of +120 °C.

Note:

The power rating may be reduced by the cable attached to the connector

Connectors for Foam Dielectric Cables

CAF® design for ultrafast installation: simply push the stripped cable end into the connector.

MultiFit® connectors are suitable for the most common cable types.

The connectors are sealed by a custom-shaped gasket or injected Plast 2000 to prevent water ingress and corrosion.

SPINNER offers a full range of N, 4.3-10 and 7-16 connectors for the most common cable types in male, female, angle and fixed socket versions.

If you can't find the connector you need below, please use the SPINNER Product Finder (<https://products.spinner-group.com>).



Cable Type	Connector					Design	Gasketing Type or PLAST 2000 Volume
	N Male	4.3-10 Male Screw Type	7-16 Male	7/8" EIA	1 5/8" EIA		
SF 1/2"-50	BN 870157 BN 870171	BN 431171	BN 847359 BN 847371	BN 715580		CAF® MultiFit	Profile gasket Profile gasket
LF 1/2"-50	BN 870189 BN 706417 BN 870168	BN 431117 BN 431168	BN 847389 BN 854317 BN 847368	BN 715568		CAF® MultiFit CAF®	O-ring O-ring 4 cm³
LF 7/8"-50	BN 706740 BN 706702 BN 706741	BN 431140 BN 431102	BN 844840 BN 854302 BN 844841	BN 715558	BN 723458	CAF® MultiFit CAF®	7 cm³ O-ring O-ring
LF 1 1/4"-50	BN 706742 BN 706420	BN 431120	BN 844842 BN 854320	BN 715587	BN 723484	CAF® MultiFit	15 cm³ O-ring
LF 1 5/8"-50	BN 706744 BN 706422	BN 431122	BN 844844 BN 854322	BN 715588	BN 723486	CAF® MultiFit	20 cm³ O-ring
LF 2 1/4"-50					BN 723473	CAF®	28 cm³

Cable compatibility:
Please see the connector data sheets available at <https://products.spinner-group.com> to check if the connector fits to your cable.

Foam Dielectric Jumper Cables

SPINNER supplies premium jumper cables in sizes 1/4", 3/8", 1/2" and 7/8" with all common connector types like N, 4.3-10, 7-16, 7/8" EIA and 1 5/8" EIA.

They feature top monitored quality to meet your particular need.

Production is fully automated to ensure consistently high quality, competitive prices and short lead times.



Connectors for Air Dielectric Cables

SPINNER connectors are famous for their superior RF performance and reliability.

CAF® design enables ultrafast installation: Simply push the stripped cable end into the connector.

All connectors

- have a sealing ring or profile between the outer conductor and body
- have sealed mating faces and inlets for pressurization
- comply with EIA STD RS-225, IEC 60339, MIL-F 24044 or IEC 60169-4/-5



Connectors for HELIFLEX Cables with O-ring sealing and Plast 2000 Smooth Flaring

Cable Type	Connector								Design	PLAST 2000 Volume in cm ³
	7-16 Male	13-30 Male	7/8" EIA	1 5/8" EIA	3 1/8" EIA	4 1/2" EIA 339 IEC 50-105	6 1/8" EIA	100-230		
HCA 38-50	BN 970628								CAF®	3
HCA 58-50	BN 925525		BN 978718						CAF®	5
HCA 78-50	BN 491818	BN 398718	BN 979128	BN 978918					CAF®	7
HCA 118-50		BN 711908		BN 858210					Premium	10
HCA 158-50			BN 839110	BN 936510					Premium	20
HCA 295-50					BN 930050				Premium	50
HCA 300-50					BN 930070				Premium	40
HCA 400-50					BN 930010				Premium	70
HCA 495-50						BN 838603			Premium	120
HCA 550-50						BN 658203	BN 656702		Premium	250
HCA 618-50							BN 871109		Premium	300
HCA 900-50								BN 514632	Premium	

Connectors for HCA 38-50, 58-50 and 78-50 cables: Gas inlet M10x0.75

Connectors for HCA 118-50 and larger cables: Gas inlet M12x1,5 an G1/8" inner thread, copper pipe 6x1 mm can be mated by flaring

Connectors for HELIAX and HELIFLEX Cables with O-ring Sealing Simple Flaring with Slits

Cable Type	Connector								
	N Male	N Female	7-16 Male	7-16 Female	7/8" EIA	1 5/8" EIA	3 1/8" EIA	4 1/2" EIA 339 IEC 50-105	6 1/8" EIA
HJ5-50	BN 492180	BN 491780	BN 491880	BN 491080	BN 979180	BN 978980			
HJ7-50A				BN 690780	BN 839180	BN 936580			
HJ8-50B							BN 930080		
HJ11-50							BN 977980	BN 838680	BN 841480
HJ9HP-50									BN 656781
HJ9-50								BN 658280	BN 656780
HCA 158-50						BN 931518			
HCA 300-50							BN 930072		
HCA 400							BN930011		

Connectors are supplied with a NPT 1/8" gas inlet.

Coupling Elements, Sealant and Gas Inlets

EIA coupling elements have PTFE insulator and stainless steel screws.

Coupling elements comply with EIA STD RS-225, IEC 60339, MIL-F 24044 or IEC 60169-4/-5.

O-ring and set of stainless steel screws are included.

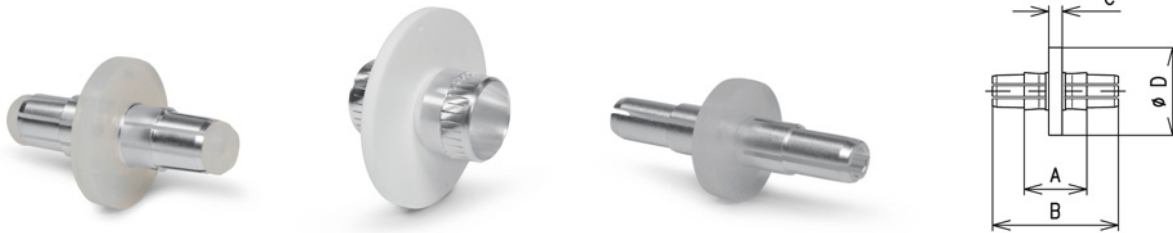

EIA Coupling Elements

Connector Size	7/8" EIA	1 5/8" EIA	3 1/8" EIA	4 1/2" EIA 339 IEC 50-105	6 1/8" EIA	
Coupling element complete with O-ring and screw set	BN 911715	BN 918311	BN 918710	BN 822810	BN 919310	
Dimensions (mm)	A	23.8	29.8	45.1	63.0	
	B	49.1	59.8	101.1	76.5	108.0
	C	4.7	6.35	9.5	9.8	11.0
	D	20.6	41.5	81.3 ¹	104.75	153.7
Spare O-ring and screw set	BN B22425	BN B22391	BN B22426	BN B22427	BN B22428	



PLAST 2000 Sealant

Part Number	
BN 151671	PLAST 2000 tube 20 cm ³ (can be screwed directly into the connector)
BN 150597	PLAST 2000 tube 70 cm ³ (injection gun BN 070551 necessary)
BN 070551	Injection gun for PLAST 2000 with thread M9



Gas Inlet Adapters

Part Number	
BN 004773	Gas inlet M10 x 0.75 for Heliflex cables 38 - 78 for hose with 6 mm inner diameter
BN 004777	Gas inlet M10 x 0.75 for Heliflex cables 38 - 78 for hose with 10 mm inner diameter
BN 004782	Gas inlet M10 x 0.75 for Heliflex cables 38 - 78 for hose with 13 mm inner diameter
BN 004771	Gas inlet M12 x 1.5 for Heliflex cables 118 - 618 for hose with 6 mm inner diameter
BN 004770	Gas inlet M12 x 1.5 for Heliflex cables 118 - 618 for hose with 10 mm inner diameter
BN 004781	Gas inlet M12 x 1.5 for Heliflex cables 118 - 618 for hose with 13 mm inner diameter

Installation Tools

SPINNER supplies trimming tools for fast, correct stripping of foam dielectric cables with corrugated outer connectors. These tools can be used in the factory or in the field to reduce the assembly time by more than 60%.

SPINNER supplies flaring tools for large air dielectric cables and 52-120 rigid line to ensure optimal RF contact. They can be equipped with inserts for different cable types.

Trimming Tools

Cable Type	Part Number
SF 1/2"-50	BN 541334 for CAF® BN 541354 for MultiFit®
LF 1/2"-50	BN 541317 for CAF® BN 541387 for MultiFit®
LF 7/8"-50	BN 541318 for CAF® BN 541301 for MultiFit®
LF 1 1/4"-50 LF 1 5/8"-50	BN 541346 - Heavy duty type with crank
HCA 58-50	BN 541341
HCA 78-50	BN 541342



Flaring Tools

Cable Type	Flaring Tool	Insert
HCA 118-50	BN 511411	BN 511447
HCA 158-50	BN 511411	BN 511457
HCA 295-50	BN 511411	BN 511481
HCA 300-50	BN 511411	BN 511469
HCA 400-50 (HCA 318-50)	BN 511411	No insert required
HCA 400-50 (HCA 318-50)	BN 511400	BN 511442
HCA 495-50	BN 511400	BN 511443
HCA 550-50	BN 511400	BN 511444
HCA 618-50	BN 511400	No insert required
Rigid line 52-120 BT	BN 511400	BN 511445



Adapters and Measurement Accessories



SPINNER carries a comprehensive range of accessories for facilitating measurement and maintenance work.

For example, we supply adapters for almost all common international connector systems, directional couplers for measuring forward and reflected power, and direct access units for testing or adjusting antennas without removing the connected lines.

SPINNER is also a world-class supplier of high-precision components for testing and calibration up to 110 GHz.

Terrestrial broadcasting applications typically operate at much lower frequencies, so we have also put together a selection of components that come in handy for performing the most common tests and measurements required for broadcasting equipment: calibration kits, precision adapters and cables, etc.

Adapters (50 Ohms)

For test purposes, SPINNER offers adapters from all EIA flanges to 7-16 female with excellent matching (VSWR ≤ 1.02). Adapters between different kinds of EIA flanges can be used indoors and outdoors to ensure full power.

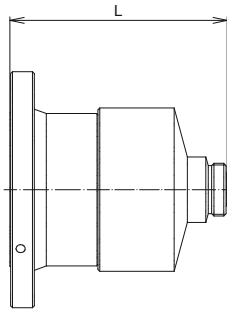

Typical drawing

Adapters - Long

Part Number	Connector 1	Connector 2	Frequency Range	VSWR	Length L	Weight
BN 640682	N female	SMA male	0 - 860 MHz	≤ 1.02	21 mm	≈ 0.028 kg
BN 293750		N female			36 mm	≈ 0.040 kg
BN 293800	7-16 male	N male	0 - 860 MHz	≤ 1.02	31 mm	≈ 0.083 kg
BN 194400		N female			15 mm	≈ 0.073 kg
BN 293900	7-16 female	N male	0 - 860 MHz	≤ 1.02	35 mm	≈ 0.074 kg
BN 294000		N female			25 mm	≈ 0.078 kg
BN 196400		7-16 female			29 mm	≈ 0.088 kg
BN 902500	7/8" EIA	N female	0 - 860 MHz	≤ 1.02	59 mm	≈ 0.25 kg
BN 805600		7-16 female			58 mm	≈ 0.24 kg
BN 818000		7-16 male			47 mm	≈ 0.24 kg
BN 908300	13-30 male	7-16 female	0 - 860 MHz	≤ 1.02	62 mm	≈ 0.45 kg
BN 291400		13-30 male			53 mm	≈ 0.56 kg
BN 190800	13-30 female	13-30 female	0 - 860 MHz	≤ 1.02	43 mm	≈ 0.30 kg
BN 903600	1 5/8" EIA	N female	0 - 860 MHz	≤ 1.02	85 mm	≈ 0.81 kg
BN 909200		7-16 female			82 mm	≈ 0.86 kg
BN 912100		7/8" EIA			109 mm	≈ 1.13 kg
BN 914300		13-30 female			116 mm	≈ 1.21 kg
BN 914200		13-30 male			106 mm	≈ 1.19 kg
BN 945700	3 1/8" EIA	N female	0 - 860 MHz	≤ 1.02	113 mm	≈ 2.28 kg
BN 909308		7-16 female			120 mm	≈ 2.40 kg
BN 917500		1 5/8" EIA			152 mm	≈ 3.49 kg
BN 728900	4 1/2" EIA ¹	7-16 female	0 - 860 MHz	≤ 1.02	180 mm	≈ 4.66 kg
BN 715000		3 1/8" EIA			177 mm	≈ 5.69 kg
BN 715001		4 1/16" MYAT				
BN 528118	52-120 BT	4 1/2" EIA	0 - 860 MHz	≤ 1.02	185 mm	≈ 4.06 kg
BN 918900	6 1/8" EIA	3 1/8" EIA	0 - 860 MHz	≤ 1.02	194 mm	≈ 8.15 kg
BN 528117		52-120 BT			200 mm	≈ 5.30 kg

¹ 339 IEC 50-105

Adapters (50 Ohms)

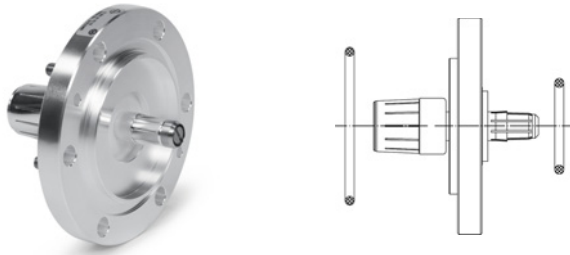

Adapters - Short

Part Number	Connector 1	Connector 2	Frequency Range	VSWR	Length L	Weight
BN 107410	1 5/8" EIA male	7-16 female	0 - 860 MHz	≤ 1.02	35 mm	≈ 0.61 kg
BN 912110		7/8" EIA male			24 mm	≈ 0.83 kg
BN 917510	3 1/8" EIA male	1 5/8" EIA male	0 - 860 MHz	≤ 1.02	15 mm	≈ 2.01 kg
BN 715010	4 1/2" EIA male ¹	3 1/8" EIA male	0 - 860 MHz	≤ 1.02	22 mm	≈ 1.50 kg
BN B03617	52-120 BT male	7-16 female	0 - 860 MHz	≤ 1.02	92 mm	≈ 3.50 kg
BN 909404	6 1/8" EIA male	7-16 female	0 - 860 MHz	≤ 1.02	110 mm	≈ 6.51 kg
BN 918910		3 1/8" EIA male			36 mm	≈ 5.73 kg
BN 714910		4 1/2" EIA male			40 mm	≈ 6.28 kg

Scope of supply includes O-rings and screw set made of stainless steel.

¹ 339 IEC 50-105

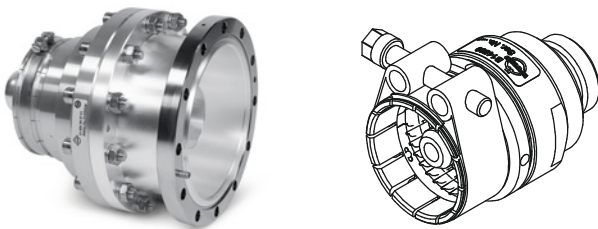

Adapters - Unflanged

Part Number	Connector 1	Connector 2	Frequency Range	VSWR	Length L	Weight
BN 918330	1 5/8" SMS inner	1 5/8" MYAT cutback	0 - 860 MHz	≤ 1.04	61 mm	≈ 0.08 kg
BN B14500	1 5/8" SMS clamp	7-16 female	0 - 860 MHz	≤ 1.04	79 mm	≈ 0.45 kg
BN 918730	3 1/8" SMS inner	3 1/8" MYAT cutback	0 - 860 MHz	≤ 1.04	75 mm	≈ 0.16 kg
BN B18263C0001	3 1/8" SMS clamp	7-16 female	0 - 860 MHz	≤ 1.04	111 mm	
BN B18263	NAX 77 clamp	7-16 female	0 - 860 MHz	≤ 1.04	109 mm	
BN B11010	RL98 cutback A	3 1/8" EIA male	0 - 860 MHz	≤ 1.04	138 mm	≈ 2.0 kg
BN B11010C0001		3 1/8" EIA			98 mm	≈ 2.0 kg
BN B08333	4 1/2" SMS clamp	43-98 BT male	0 - 860 MHz	≤ 1.04	90 mm	
BN 715002		4 1/16" MYAT male			143 mm	
BN B25971	4 1/2" EIA	RL98 cutback A	0 - 860 MHz	≤ 1.04	101 mm	
BN B11310	RL120 cutback A	4 1/2" EIA	0 - 860 MHz	≤ 1.04	185 mm	≈ 6.9 kg
BN B03617C0001	NAX 120 clamp	7-16 female	0 - 860 MHz	≤ 1.04	153 mm	≈ 1.5 kg
BN B03617C0000	52-120 SMS clamp	7-16 female	0 - 860 MHz	≤ 1.04	172 mm	≈ 1.5 kg
BN B22055		NAX 120 unflanged	0 - 860 MHz	≤ 1.04	210 mm	≈ 5.0 kg
BN 542720C0001	6 1/8" EIA	4 1/2" EIA	0 - 860 MHz	≤ 1.04	268 mm	≈ 7.0 kg
BN 542701		52-120 SMS clamp	0 - 860 MHz	≤ 1.04	245 mm	≈ 9.5 kg

Adapters (75 Ohms)

For measurements SPINNER offers adapters to N female with excellent matching ($V_{SWR} \leq 1.02$)

Adapters between various flanges can be used for full power.

Short adapters with integrated coupling elements save space and cost.

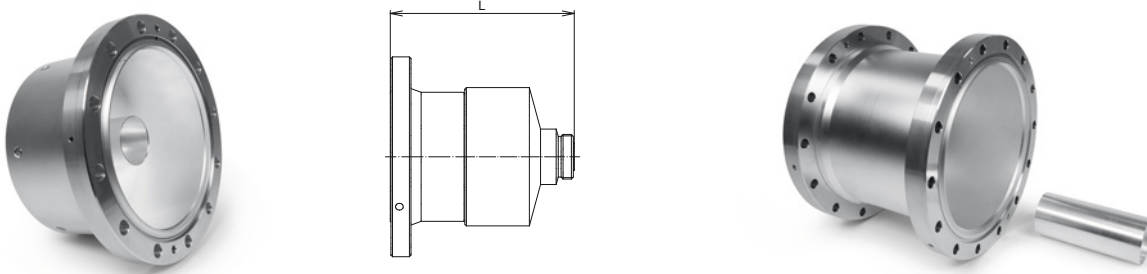

Adapters - Long, Made of Aluminum

Part Number	Connector 1	Connector 2	Frequency Range	VSWR	Length L	Weight
BN 750060	6 1/8" EIA	N female	0 - 860 MHz	≤ 1.02	180 mm	3.5 kg
BN 750076	7 3/16" MYAT	7 3/16" MYAT	0 - 752 MHz	≤ 1.02	183 mm	5.0 kg
BN 750086	8 3/16" MYAT	8 3/16" MYAT	0 - 700 MHz	≤ 1.02	190 mm	7.3 kg



Adapters - Short, Made of Brass Including O-Rings and Screw Set Made of Stainless Steel

Part Number	Connector 1	Connector 2	Frequency Range	VSWR	Length L	Weight
BN 750070	7 3/16" MYAT male	6 1/8" EIA male	0 - 752 MHz	≤ 1.02	190 mm	11.3 kg
BN 750080	8 3/16" MYAT male	6 1/8" EIA male	0 - 700 MHz	≤ 1.02	193 mm	15.1 kg

Adapters (75 Ohms)

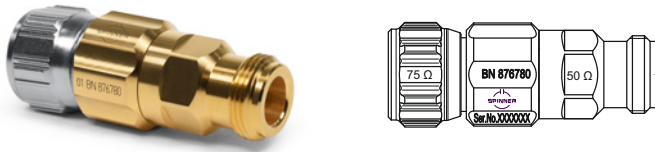

Adapters N 75 Ohm to 50 Ohm – Mechanical Adapter without RF Matching

Part Number	Connector 1	Connector 2	Frequency Range	VSWR	Length L	Weight
BN 876780	N male 75 Ω	N female 50 Ω	DC - 18 MHz	N/A	52 mm	0.06 kg

Calibration Standards for 75 Ohm Systems

See below for a selection of our 75 Ohm measurement accessories

For further information please visit our Product Finder: <https://products.spinner-group.com>



Description	Part Number	Connectors	Impedance	Frequency Range	Length L	Max. Power	Weight
4-in-1 OSLT-Kit N 75 Ohm	BN 533857R000	N female 75 Ω	75 Ω	DC - 3 GHz	94 mm	N/A	0.25 kg
Precision Load 75 Ohm	BN 876784	N male (75 Ω)	75 Ω + 0.75 Ω (DC)	DC - 3 GHz	45 mm	0.5 W	0.06 kg

Measurement Accessory Kit for 75 Ohm Direct Access Units

BN 876794 Scope of supply:

Description	Part Number	Connectors	Impedance
4-in-1 OSLT-kit	BN 533857R000	N female	75 Ω
Short	BN 876785	N male	75 Ω
Load	BN 876784	N male	75 Ω
Cable, 30 cm	BN A77368	N male / N male	75 Ω
Adapter	BN 876780	N male / N female	75 Ω / 50 Ω

Trimming Lines

- Used to improve the VSWR
- With 5 trimming screws
- For indoor application

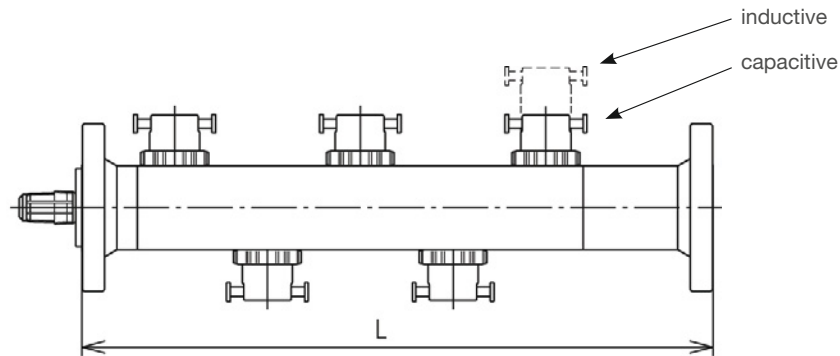

Part Number	BN B00473	BN 525623	BN 529250	BN B10578	BN 538540	BN 538529
Frequency range	470 - 800 MHz					
Proof voltage	≤ 2.0 kV	≤ 2.7 kV	≤ 5.0 kV	≤ 12.0 kV	≤ 15.0 kV	≤ 25.0 kV
Average power (860 MHz) at +40 °C ambient temperature	≤ 2.0 kW	≤ 2.6 kW	≤ 7.0 kW	≤ 23.0 kW	≤ 38.0 kW	≤ 78.0 kW
Connector 1	7-16 female	7/8" EIA ¹	1 5/8" EIA ¹	3 1/8" EIA ¹	4 1/2" EIA ¹ (339 IEC 50-105)	6 1/8" EIA ¹
Number of trimming screws	5					
Length	195 mm	on request	340 mm	400 mm	450 mm	450 mm
Weight	≈ 1.38 kg	on request	≈ 2.90 kg	≈ 5.10 kg	≈ 10.80 kg	≈ 14.10 kg

¹ One side with solid built-in coupling element

The proof voltage is valid for trimming screws entirely screwed in.

Trimming lines can be connected in series to increase the tuning range for lower frequencies.

Wall Feed Throughs

- Fixed adapters with coupling element
- For 50 ohms systems
- Protection caps included
- For outdoor application

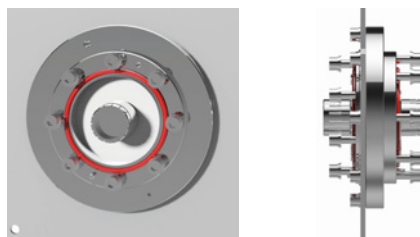

Part Number	BN 657308C0001	BN 834805C0001	BN 648697C0001	BN 837305
Inner face	1 5/8" EIA male	3 1/8" EIA male	4 1/2" EIA male	52-120 SMS clamp
Outer face	1 5/8" EIA male	3 1/8" EIA male	4 1/2" EIA male	6 1/8" EIA male
Frequency range	0 - 800 MHz			
VSWR	< 1.02			
Wall thickness	5 – 10 mm	5 – 10 mm	5 – 8 mm	5 – 10 mm
Length L	44 mm	51 mm	60 mm	35 mm
Weight	2.0 kg	3.5 kg	5.4 kg	6.2 kg
Environmental conditions	For limitations see „Environmental Conditions for Broadcast Products“.			

Direct Access Units

- Quick and direct access to coaxial line ports
- Accurate measurement of VSWR and electrical lengths via galvanic contacts
- Antenna testing and tuning without removing connected feeders
- For outdoor use
- Compliant with all broadcast standards
- Measurement insert is supplied with storage case including spare parts



Part Number	BN 390906	BN 847712	BN 847710	BN 876610	BN 876706
Connectors	1 5/8" EIA	3 1/8" EIA	3 1/8" EIA	4 1/2" EIA 339 IEC 50-105	6 1/8" EIA
Characteristic impedance	50 Ω				
Frequency range	0 - 860 MHz				
Proof voltage ¹	7.0 kV	12.0 kV	14.0 kV	18.0 kV	22.0 kV
Average power ²	100 MHz ≤ 20.0 kW 230 MHz ≤ 13.5 kW 860 MHz ≤ 7.0 kW	≤ 51.0 kW ≤ 34.0 kW ≤ 17.5 kW	≤ 67.0 kW ≤ 44.0 kW ≤ 23.0 kW	≤ 98.0 kW ≤ 64.0 kW ≤ 35.0 kW	≤ 140.0 kW ≤ 92.0 kW ≤ 47.0 kW
VSWR	≤ 1.02				
Return loss	≥ 40 dB				
Length	240.0 mm	350.6 mm	358.0 mm	360.0 mm	520.0 mm
Weight	≈ 3.67 kg	≈ 6.80 kg	≈ 6.50 kg	≈ 13.00 kg	≈ 20.50 kg
Measurement insert and case	BN 495951	BN 290903	BN 590302		BN 315401
Measuring connectors	7-16 female				
Characteristic impedance	50 Ω				
VSWR (return loss) ≤ 1.02 (40 dB)	0 - 860 MHz				
Weight	≈ 2.2 kg	≈ 3.0 kg	≈ 5.75 kg		≈ 8.2 kg

¹ At sea level, 86 - 106 kPa

² At +40 °C ambient temperature

Direct Access Units

- RF measurements without dismantling rigid lines and cables
- Quick and accurate:
 - Antenna impedance testing and tuning
 - Measurement of feeder VSWR and electrical length
- No need for measurement adapters
- For outdoor application
- No limitation of power and voltage by direct access unit
- Measurement insert is supplied with storage case incl. spare parts



Part Number	BN 876730	BN 876770	BN 876740	BN 876750	BN 876760
Connectors	6 1/8" EIA male/male	6 1/8" EIA male/male	7 3/16" MYAT male/male	8 3/16" MYAT male/male	9 3/16" EIA male/male
Characteristic impedance	50 Ω	75 Ω	75 Ω	75 Ω	50 Ω
Frequency range	0 - 800 MHz	0 - 800 MHz	0 - 752 MHz	0 - 700 MHz	0 - 550 MHz
Proof voltage	28.0 kV	28.0 kV	32.0 kV	38.0 kV	41.0 kV
Average power	100 MHz ≤ 172.0 kW 254 MHz ≤ 112.0 kW 550 MHz ≤ 76.0 kW 700 MHz ≤ 67.0 kW 752 MHz ≤ 65.0 kW 800 MHz ≤ 63.0 kW	≤ 145.0 kW ≤ 94.0 kW ≤ 64.0 kW ≤ 57.0 kW ≤ 55.0 kW ≤ 53.0 kW	≤ 202.0 kW ≤ 131.0 kW ≤ 89.0 kW ≤ 78.0 kW ≤ 76.0 kW	≤ 256.0 kW ≤ 167.0 kW ≤ 113.0 kW ≤ 100.0 kW	≤ 360.0 kW ≤ 234.0 kW ≤ 160.0 kW
VSWR	≤ 1.03				
Return loss	≥ 36 dB				
Length (flange to flange)	177.0 mm	177.0 mm	200.0 mm	220.0 mm	212.0 mm
Weight	≈ 17.0 kg	≈ 17.0 kg	≈ 24.0 kg	≈ 34.0 kg	≈ 37.0 kg
Measurement insert and case	BN 876735	BN 876775	BN 876745	BN 876755	BN 876765
Measuring connectors	7-16 female	N female	N female	N female	7-16 female
Characteristic impedance	50 Ω	75 Ω	75 Ω	75 Ω	50 Ω
VSWR (return loss) ≤ 1.02 (40 dB) ≤ 1.06 (30 dB)	0 - 700 MHz 700 - 800 MHz	0 - 700 MHz 700 - 800 MHz	0 - 700 MHz 700 - 752 MHz	0 - 610 MHz 610 - 700 MHz	0 - 500 MHz 500 - 550 MHz
Weight	≈ 13.0 kg	≈ 13.0 kg	≈ 15.0 kg	≈ 16.0 kg	≈ 16.0 kg
Measurement accessory kit for 75 Ohm direct access unit	BN 876794				
Scope of delivery	4-in-1 calkit, short, load, cable (75 Ω each) and adapter 75 Ω/50 Ω				
Maintenance kit	BN 876731	BN 876771	BN 876741	BN 876751	BN 876761
Scope of supply	O-ring, grease and set of screws and nuts				
Environmental conditions	For limitations see "Environmental Conditions for Broadcast Products".				

Directional Couplers with Two Probes

- High directivity
- Coupling varies with frequency
- Coupling is adjusted at reference frequency
- Low VSWR
- Suitable for a wide frequency range
- For indoor application
- Termination load is included

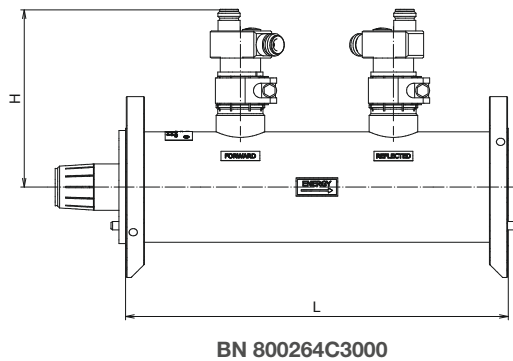
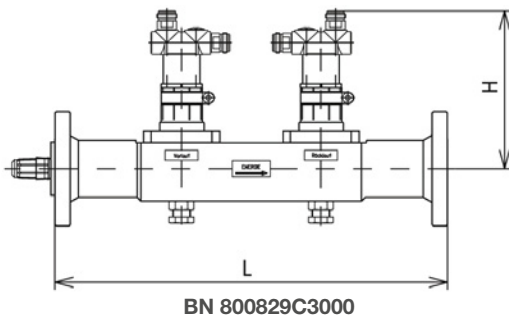

Part Number	BN 800829C3000	BN 800264C3000	BN 800364C3000	BN 516758C3000	BN 516764C3000
Frequency range	0 - 40 MHz				
Reduced performance	40 - 860 MHz				
Full performance	40 - 800 MHz				
Reduced performance	860 MHz - 2.1 GHz	860 MHz - 1.3 GHz	860 MHz - 1.0GHz	n. a.	n. a.
Proof voltage at sea level (NN)	≤ 7 kV	≤ 14 kV	≤ 19 kV	≤ 22 kV	≤ 28 kV
Average power (at +40 °C ambient temperature)	100 MHz ≤ 20.0 kW 230 MHz ≤ 13.5 kW 860 MHz ≤ 7.0 kW	≤ 67 kW ≤ 44 kW ≤ 23 kW	≤ 112 kW ≤ 74 kW ≤ 38 kW	≤ 170 kW ≤ 116 kW ≤ 60 kW	≤ 224 kW ≤ 148 kW ≤ 78 kW (800 MHz)
Coupling range	88 - 108 MHz: 38 - 72 dB 170 - 230 MHz: 31 - 64 dB 470 - 860 MHz: 25 - 53 dB	42 - 74 dB 35 - 67 dB 29 - 57 dB	46 - 78 dB 38 - 71 dB 32 - 60 dB	48 - 82 dB 42 - 75 dB 34 - 64 dB	49.5 - 81 dB 43.0 - 74 dB 31 - 63 dB (800 MHz)
Tolerance of coupling at reference frequency f_{ref}	≤ ±0.1 dB				
Variation of coupling at other frequencies	$-20 \log_{10} (f/f_{ref})$				
VSWR main line	≤ 1.04				
Directivity	34 - 40 dB				
Insertion loss	≤ 0.05 dB				
Connectors main line	1 5/8" EIA male/female	3 1/8" EIA ¹ male/female	4 1/2" EIA ¹ male/female 339 IEC 50-105	52 - 120 BT male/female	6 1/8" EIA male/female
Connectors coupled line	N female				
Termination load 1 W included	Do not overload termination load. Please define an adequate coupling factor.				
Dimensions (L x H) mm	310 x 125	275 x 160	275 x 166	330 x 172	400 x 213
Weight	≈ 3.55 kg	≈ 4.3 kg	≈ 5.4 kg	≈ 7.0 kg	≈ 12.8 kg
Environmental conditions	For limitations see "Environmental Conditions for Broadcast Products".				

¹ Coupling element can be removed

Directional Couplers (1 ... 5 Probes)

- High directivity
- Coupling varies with frequency
- Coupling is adjusted at reference frequency
- Low VSWR
- Suitable for a wide frequency range
- For indoor application
- Termination load is included

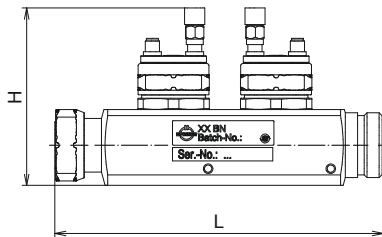

BN 800468

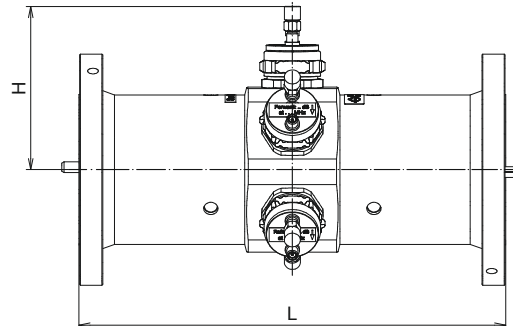

BN 800265C0005

Part Number	1-way 2-way 3-way 4-way 5-way	— BN 800468 BN 800468C0003 — —	BN 800865C0001 BN 800865C0002 BN 800865C0003 — —	— BN 800265C0002 BN 800265C0003 BN 800265C0004 BN 800265C0005	— BN 800365C0002 BN 800365C0003 BN 800365C0004 BN 800365C0005
Frequency range					
Reduced performance					0 - 40 MHz
Full performance					40 - 860 MHz
Reduced performance		860 MHz - 3.0 GHz	860 MHz - 2.1 GHz	860 MHz - 1.3 GHz	860 MHz - 1.0 GHz
Proof voltage at sea level (NN)		≤ 3 kV	≤ 7 kV	≤ 14 kV	≤ 19 kV
Average power (at +40 °C ambient temperature)	100 MHz 230 MHz 860 MHz	≤ 5.3 kW ≤ 3.8 kW ≤ 2.0 kW	≤ 20.0 kW ≤ 13.5 kW ≤ 7.0 kW	≤ 67 kW ≤ 44 kW ≤ 23 kW	≤ 112 kW ≤ 74 kW ≤ 38 kW
Coupling range	88 - 108 MHz 170 - 230 MHz 470 - 860 MHz	51 - 75 dB 45 - 69 dB 36 - 57 dB	58 - 86 dB 52 - 80 dB 43 - 68 dB	61 - 91 dB 56 - 85 dB 47 - 73 dB	65 - 96 dB 60 - 90 dB 51 - 78 dB
Tolerance of coupling at reference frequency f_{ref}					≤ ±0.1 dB
Variation of coupling at other frequencies					-20 log ₍₁₀₎ (f/f _{ref})
VSWR main line					≤ 1.04
Directivity					34 - 40 dB
Insertion loss					≤ 0.05 dB
Connectors main line		7-16 male/female	1 5/8" EIA female/female	3 1/8" EIA female/female	4 1/2" EIA female/female (339 IEC 50-105)
Connectors coupled line					SMA female
Termination load 1 W included					Do not overload termination load. Please define an adequate coupling factor.
Dimensions (L x H) mm		148 x 98.5	150 x 92	240 x 110.5	300 x 122.5
Weight		≈ 0.6 kg	≈ 1.1 kg	≈ 3.5 kg	≈ 5.3 kg
Environmental conditions					For limitations see "Environmental Conditions for Broadcast Products".

Directional Couplers, "PLUS" (1 ... 5 Probes)

- Enhanced coupling
- High directivity
- Coupling varies with frequency
- Coupling is adjusted at reference frequency
- Low VSWR
- Suitable for a wide frequency range
- For indoor application
- Termination load is included

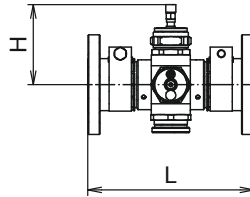

BN 800871

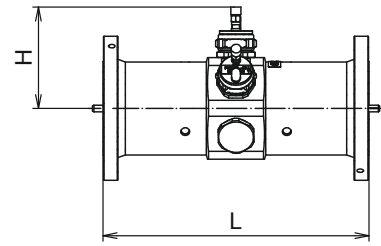

BN 800271C0003

Part Number	1-way 2-way 3-way 4-way 5-way	— BN 800471 — — —	BN 800871C0001 BN 800871C0002 BN 800871C0003 — —	— BN 800271C0002 BN 800271C0003 BN 800271C0004 BN 800271C0005	— BN 800371C0002 BN 800371C0003 BN 800371C0004 BN 800371C0005
Frequency range					
Reduced performance					0 - 40 MHz
Full performance					40 - 860 MHz
Reduced performance		860 MHz - 3.0 GHz	860 MHz - 2.1 GHz	860 MHz - 1.3 GHz	860 MHz - 1.0 GHz
Proof voltage at sea level (NN)		≤ 3 kV	≤ 7 kV	≤ 14 kV	≤ 19 kV
Average power (at +40 °C ambient temperature)	100 MHz 230 MHz 860 MHz	≤ 5.3 kW ≤ 3.8 kW ≤ 2.0 kW	≤ 20.0 kW ≤ 13.5 kW ≤ 7.0 kW	≤ 67 kW ≤ 44 kW ≤ 23 kW	≤ 112 kW ≤ 74 kW ≤ 38 kW
Coupling range	88 - 108 MHz 170 - 230 MHz 470 - 860 MHz	43 - 67 dB 37 - 61 dB 29 - 49 dB	51 - 78 dB 44 - 72 dB 35 - 60 dB	51 - 78 dB 46 - 75 dB 37 - 63 dB	54 - 84 dB 49 - 87 dB 40 - 66 dB
Tolerance of coupling at reference frequency f_{ref}					≤ ±0.1 dB
Variation of coupling at other frequencies					-20 log ₍₁₀₎ (f/f _{ref})
VSWR main line					≤ 1.04
Directivity					34 - 40 dB
Insertion loss					≤ 0.05 dB
Connectors main line		7-16 male/female	1 5/8" EIA female/female	3 1/8" EIA female/female	4 1/2" EIA female/female (339 IEC 50-105)
Connectors coupled line					SMA female
Termination load 1 W included					Do not overload termination load. Please define an adequate coupling factor.
Dimensions (L x H) mm		148 x 98.5	150 x 92	240 x 110.5	300 x 122.5
Weight		≈ 0.6 kg	≈ 1.1 kg	≈ 3.5 kg	≈ 5.3 kg
Environmental conditions					For limitations see "Environmental Conditions for Broadcast Products".

Adapters & Measurement Accessories

Directional Couplers, "Flat Response" (1 ... 5 Probes)

- Constant coupling
- High directivity
- Suitable in a wide frequency range
- Low VSWR
- For indoor application
- Termination load is included

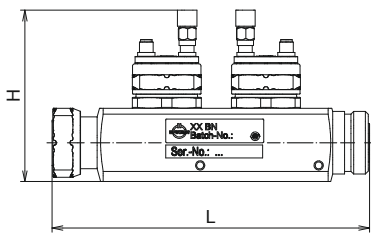

BN 800468C2002

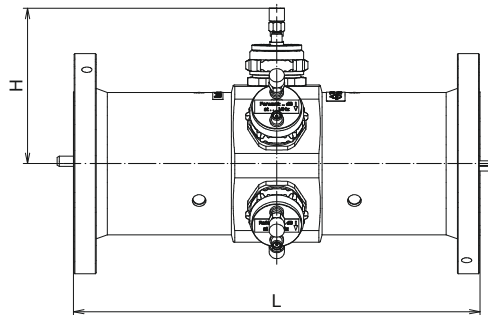

BN 800265C2005

Part Number	1-way	2-way	3-way	4-way	5-way
	—	BN 800468C2002	—	—	—
	—	—	BN 800865C2001	BN 800865C2002	BN 800865C2003
	—	—	—	—	—
	—	—	—	BN 800265C2002	BN 800265C2003
	—	—	—	BN 800265C2004	BN 800265C2005
	—	—	—	—	—
Frequency range	470 - 860 MHz				
Proof voltage at sea level (NN)	≤ 3 kV	≤ 7 kV	≤ 14 kV	≤ 19 kV	
Average power (at +40 °C ambient temperature)	≤ 2 kW	≤ 7 kW	≤ 23 kW	≤ 38 kW	
Coupling range	41 - 68 dB	50 - 78 dB	54 - 80 dB	56 - 80 dB	
	Attention: Total power level at monitoring port must not be higher than 17 dBm (= 50mW)				
Tolerance of coupling	± 0.15 dB (at VSWR < 1.02 at the probe port)				
VSWR main line	≤ 1.04				
Directivity	34 - 40 dB				
Insertion loss	≤ 0.05 dB				
Connectors main line	7-16 male/female	1 5/8" EIA female/female	3 1/8" EIA female/female	4 1/2" EIA female/female (339 IEC 50-105)	
Connectors coupled line	SMA female				
Termination load 1 W included	Do not overload termination load. Please define an adequate coupling factor.				
Dimensions (L x H) mm	148 x 98.5	150 x 92	240 x 110.5	300 x 122.5	
Weight	≈ 0.6 kg	≈ 1.1 kg	≈ 3.5 kg	≈ 5.3 kg	
Environmental conditions	For limitations see "Environmental Conditions for Broadcast Products".				

Measurement Accessories

- Calibration kits for more accurate measurements (directivity, return loss, insertion loss)
- Precision adapters with improved surfaces that greatly increase the number of mating cycles
- Precision adapters without O-rings for faster use
- Open ports should be terminated by precision loads to prevent reflections from causing measurement errors.

Product	Description	Part Number	
4-in-1 OSLT calibration kit 50 Ω 7-16 female 0 ≤ f ≤ 6 GHz Incl. test report	For calibrating directly on 7-16 male connectors, includes all required standards for multiport calibration (open, short, load & thru) in one compact unit.	BN 533845	
4-in-1 OSLT calibration kit 50 Ω N female 0 ≤ f ≤ 6 GHz Incl. test report	For calibrating directly on N-male connectors, includes all required standards for multiport calibration (open, short, load & thru) in one compact unit.	BN 533843	
4-in-1 OSLT calibration kit 75 Ω N female 0 ≤ f ≤ 3 GHz Incl. test report	For calibrating directly on N-male connectors, includes all required standards for multiport calibration (open, short, load & thru) in one compact unit.	BN 533857R000	
Precision measurement adapter 7-16 male / N female 0 ≤ f ≤ 7.5 GHz Incl. test report	Hard wearing center conductor, gold plated, for highest durability; for measurement use with improved surfaces for many cycles. Return loss 0 - 3.0 GHz > 40 dB 0 - 7.5 GHz > 36 dB	BN 194403	
Measurement cable SF3/8" 4.5 m 7-16 male / 7-16 male 0 ≤ f ≤ 2.2 GHz	For intermodulation measurements IM3 ≤ -160 dBc with 2 x 20 W Return loss 0 - 0.9 GHz > 32 dB 0 - 2.2 GHz > 28 dB	BN J50004	
Precision load 0.5 W 7-16 male 0 ≤ f ≤ 7.5 GHz	For termination of open 7-16 female ports Return loss 0 - 7.5 GHz > 44 dB	BN 533733R000	
Precision load 0.5 W N male 0 ≤ f ≤ 18 GHz	For termination of open N female ports. Return loss 0 - 6 GHz > 42 dB 6 - 9 GHz > 35 dB 9 - 18 GHz > 32 dB	BN 533910R000	
Attenuator 5 W / 10 dB N male / N female 0 ≤ f ≤ 12 GHz	To protect test equipment from unknown high power signals, recommended for measurements on high power transmitter sites Return loss 0 - 4 GHz > 23 dB 0 - 12 GHz > 15 dB	BN 528626	
Attenuator 5 W / 20 dB N male / N female 0 ≤ f ≤ 12 GHz	To protect test equipment from unknown high power signals, recommended for measurements on high power transmitter sites Return loss 0 - 4 GHz > 23 dB 0 - 12 GHz > 15 dB	BN 528627	

Loads



Loads and attenuators have to meet diverse requirements in terms of performance and connector systems, and the new system makes it simple for you to get exactly what you need.

SPINNER supplies loads for various applications including:

- Precision low-power loads for measurement and network analyzer calibration up to 67GHz
- Low PIM loads for measurement
- Medium-power loads for terminating ports and balancing channel and power combiners
- High-power loads for testing transmitters up to 55kW

Different cooling types are available depending on the absorbed power and application:

- Natural cooling for loads up to 2.5kW
- Fan cooling for loads up to 5 kW
- Liquid cooled loads with integrated or external coolers

1 W – 50 W Loads

- Low return loss for measurement applications
- Free of lead and BeO
- Convection cooled
- Indoor



BN 392489



BN 392490



BN 193690

Part Number	BN 392489	BN 392490	BN 193690
Average power		≤ 1 W	
Connector	SMA male	N male	7-16 male
Frequency range	0 - 5 GHz		
VSWR	0 ≤ f ≤ 1 GHz 1 ≤ f ≤ 3 GHz 3 ≤ f ≤ 5 GHz	≤ 1.02 ≤ 1.06 ≤ 1.10	
Proof voltage	50 V		
Dimensions (L x D) mm	16 x 9	56 x 18	44 x 18
Weight	≈ 4 g	≈ 80 g	≈ 120g
Operation position	Any		
Ambient temperature	-40 °C ≤ θ ≤ +60 °C		

1 W – 50 W Loads

- Low return loss for measurement applications
- Free of lead
- Convection cooled
- Indoor

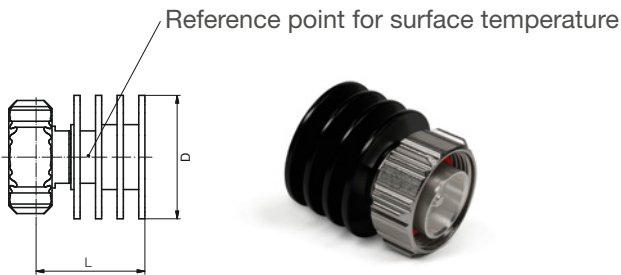

Part Number	BN 531727	BN 531712	BN 531221	BN 531225	BN 527751	BN 527757	BN 547700
Average power (obey derating rule)	≤ 5 W ^{2.1}		≤ 10 W ^{2.2}		≤ 25 W ^{2.3}		≤ 50 W ^{2.3}
Connector	N male	7-16 male	N male	7-16 male	N male	7-16 male	7-16 male
Frequency range	0 - 7 GHz						0 - 4 GHz
VSWR	0 ≤ f ≤ 1 GHz 1 ≤ f ≤ 2 GHz 2 ≤ f ≤ 3 GHz 3 ≤ f ≤ 4 GHz 4 ≤ f ≤ 5 GHz 5 ≤ f ≤ 7 GHz		≤ 1.02 ≤ 1.11 ≤ 1.11 ≤ 1.17 ≤ 1.17 ≤ 1.22		≤ 1.07 ≤ 1.10 ≤ 1.17 ≤ 1.22		
Proof voltage	1 kV						1.2 kV
Dimensions (L x D) mm	35 x 24	26 x 24	45 x 40	35 x 40	73 x 40	63 x 40	96 x 60
Weight	≈ 40 g	≈ 100 g	≈ 80 g	≈ 130 g	≈ 120 g	≈ 200 g	≈ 380 g
Operation position	Any						
Ambient temperature	-40 °C ≤ t ≤ +40 °C						

2.1 Power Derating Curves

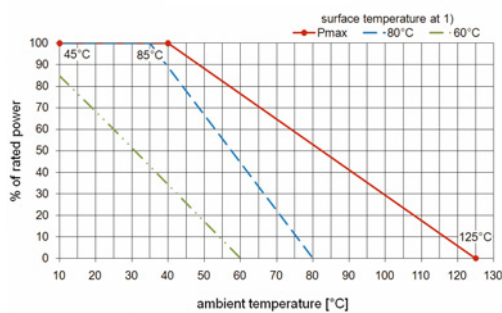

2.2 Power Derating Curves

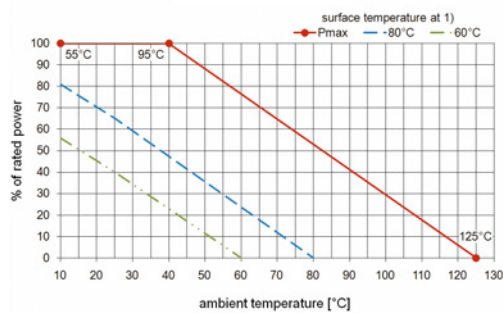

2.3 Power Derating Curves

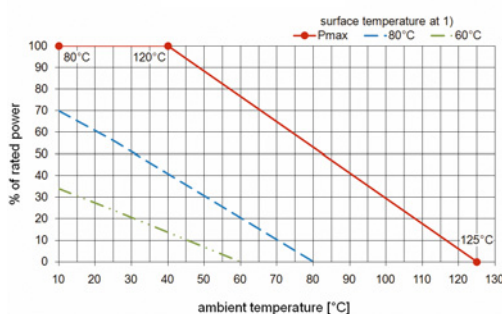

100 W – 200 W Loads

- Low return loss
- Free of lead and BeO
- Convection cooled
- IP50 per EN 60529



Part Number	BN 622003	BN 622007	BN 622005
Average power	$\leq 100 \text{ W}^{2.1}$		$\leq 200 \text{ W}^{2.2}$
Connector	7-16 male	7-16 female	7-16 female
Frequency range	0 - 4 GHz		
VSWR	$0 \leq f \leq 1 \text{ GHz}$ $1 \leq f \leq 2 \text{ GHz}$ $2 \leq f \leq 3 \text{ GHz}$ $3 \leq f \leq 4 \text{ GHz}$	≤ 1.06 ≤ 1.14 ≤ 1.2 ≤ 1.3	
Proof voltage	1.2 kV		
Dimensions (L x D x H) mm	124 x 66 x 108	127 x 66 x 108	170 x 107 x 108
Weight	$\approx 1.1 \text{ kg}$	$\approx 1.1 \text{ kg}$	$\approx 2.7 \text{ kg}$
Operation position	Cooling fins must be vertically.		
Ambient temperature	$-40 \text{ }^\circ\text{C} \leq \vartheta \leq +40 \text{ }^\circ\text{C}$		

2.1 Power Derating Curves

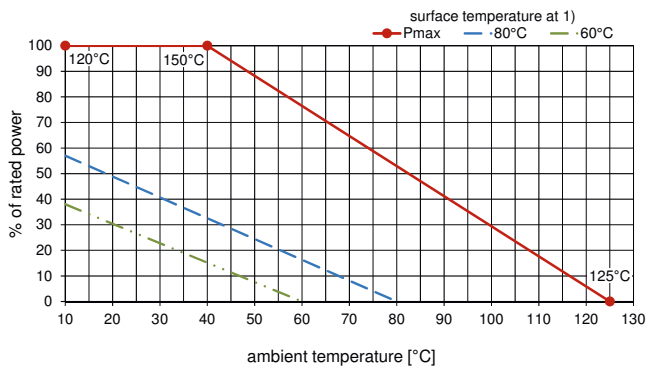

2.2 Power Derating Curves

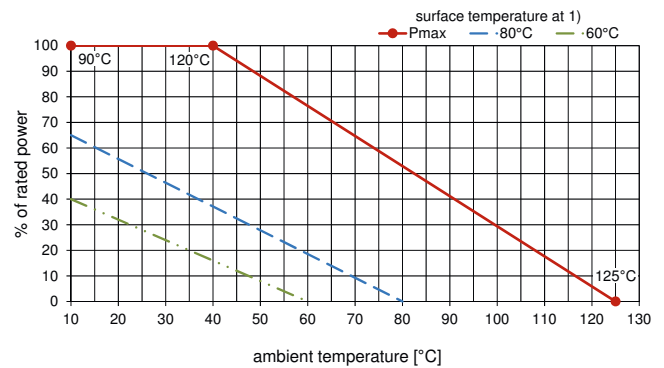

400 W – 2000 W Loads

- Low return loss
- Free of lead
- Convection cooled
- Indoor

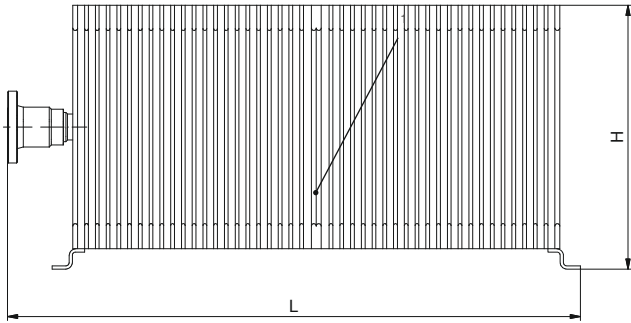

1 reference point for surface temperature



Part Number	BN 537740	BN 537750	BN 537761	BN 537770
Average power (obey derating curve)	≤ 400 W	≤ 600 W	≤ 1 kW	≤ 2 kW
Connector	7-16 female			1 5/8"EIA
Frequency range	0 - 860 MHz			
VSWR	≤ 1.06			
Proof voltage	≤ 1.2 kV		≤ 2 kV	
Dimensions (L x D x H) mm	269 x 113 x 275	289 x 113 x 325	340 x 199 x 325	706 x 210 x 325
Weight	≈ 5 kg	≈ 6 kg	≈ 14 kg	≈ 32 kg
Operation position	Cooling fins must be vertically.			
Ambient temperature	-40 °C ≤ ϑ ≤ +40 °C			

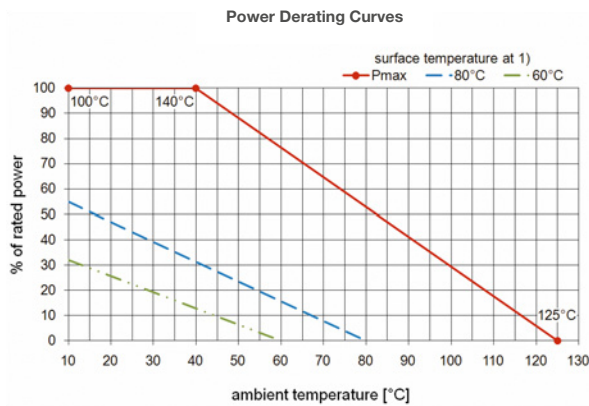

625 W – 2500 W Loads without Heat Sink

- Low return loss
- Free of lead
- For mounting on cooling system
- Indoor

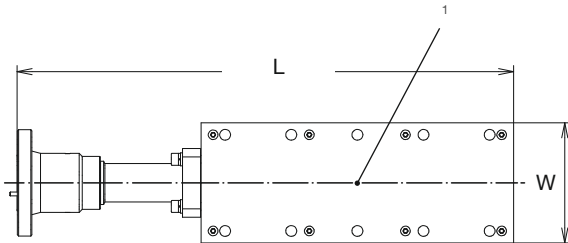

1 Reference point for surface temperature



Part Number	BN 537701	BN 537702	BN 155361
Average power	≤ 625 W	≤ 1.25 kW	≤ 2.5 kW
Connector	7-16 female		1 5/8" EIA
Frequency range	0 - 860 MHz		
VSWR	≤ 1.06		≤ 1.1
Proof voltage	2 kV		
Dimensions (L x D x H) mm	202 x 33 x 66	232 x 33 x 80	413 x 54 x 100
Weight	≈ 1 kg	≈ 1.2 kg	≈ 4.3 kg
Operation position	Any		
Heat sink requirement	External cooling system must limit temperature to 110° C at reference point.		

1.6 kW – 2.5 kW Loads

- Low return loss
- BN 537779 for DAB harmonics measurements
- Free of lead
- Convection cooled
- Indoor

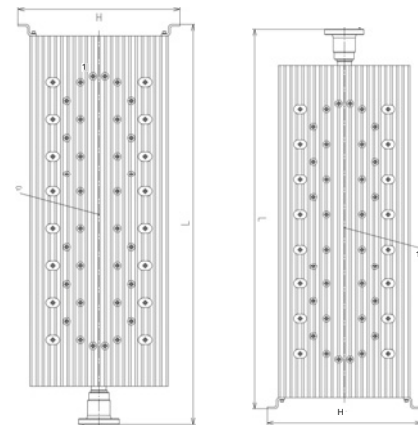
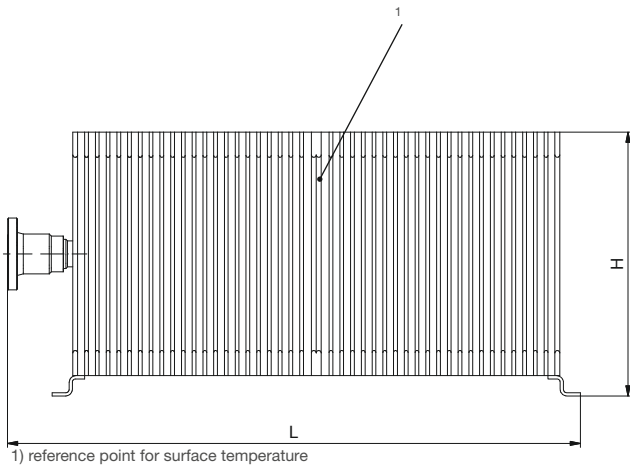
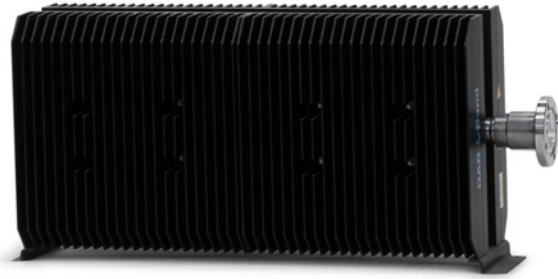

BN 537779

BN 537794

Part Number	BN 537779	BN 537794
Average power	≤ 1.6 kW ^{2.1}	≤ 2.5 kW ^{2.2}
Connector	1 5/8" EIA	
Frequency range	0 - 4.5 GHz	0 - 860 MHz
VSWR	0 ≤ f ≤ 860 MHz ≤ 1.15 1452 ≤ f ≤ 1492 GHz ≤ 1.1 2904 ≤ f ≤ 2984 GHz ≤ 1.9 4356 ≤ f ≤ 4476 GHz ≤ 1.9	≤ 1.1
Proof voltage	1.5 kV	2.5 kV
Dimensions (L x D x H) mm	706 x 210 x 325	870 x 215 x 350
Weight	≈ 32 kg	
Operation position	Cooling fins must be vertically.	
Ambient temperature	-40 °C ≤ t ≤ +40 °C	

2.1 Power Derating Curves

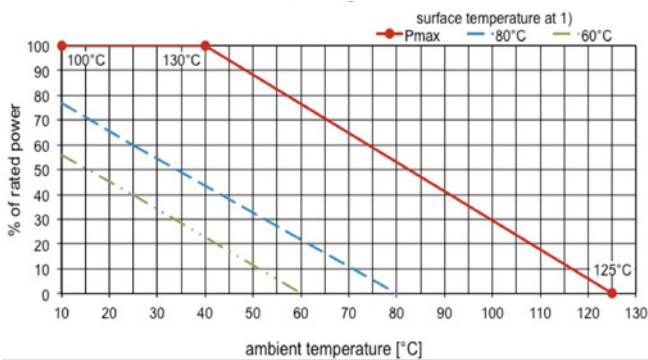

2.2 Power Derating Curves

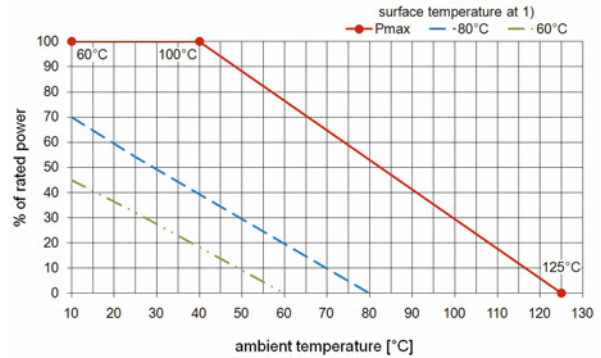

5 kW Load with Fan Cooling

- Coaxial load with intelligent control
- Fan only activated when needed
absorbed RF power < 250 W: passive cooling
absorbed RF power > 250 W: fan cooling
- Full power allowed from standby
- 4 potential-free interlock contacts
- Low return loss
- Free of lead
- Indoor installation in any position



Part Number	BN 534260
Average power	≤ 5 kW
Connector	1 5/8" EIA
Frequency range	0 - 860 MHz
VSWR	≤ 1.11
Proof voltage	2.5 kV
Mains	115 - 230 V, 50 - 60 Hz
Power consumption	25 W (standby), 150 W (full operation)
Interlock contact	Four potential-free, max. 42.4 V AC / 60 V DC, max. 1 A
Noise level	≈ 55 dB (A)
Operation position	Any – Air input and output must be free to allow air flow.
Dimensions (L x D x H) mm	764 x 195 x 345
Weight	≈ 32 kg
Ambient temperature	-15 °C ≤ ϑ ≤ +45 °C
Storage temperature	-35 °C ≤ ϑ ≤ +85 °C

10 kW – 25 kW Smart Loads with Liquid Cooling

- Coaxial load and cooler with intelligent control
- Pump and fan only activated when needed
 - 10 kW:
 - absorbed RF power < 80 W: passive cooling
 - absorbed RF power ≥ 80 W: pump and fan
 - 25 kW:
 - absorbed RF power < 80 W: passive cooling
 - absorbed RF power 80 - 800 W: pump only
 - absorbed RF power > 800 W pump and fan
- Full power allowed from standby
- Potential-free interlock with fast self protection
- Low return loss
- 115 V or 230 V single phase mains
- Indoor



Part Number	230 V, 50-60 Hz 115 V, 50-60 Hz	BN 546423 BN 546423C0001		BN 546404C0200 BN 546404C0201	
Average power		10 kW		25 kW	
Pulse Power		On request		On request	
Connector		3 1/8" EIA, facing upwards 4 1/2" EIA necessary for P ≥ 23 kW @ 470 to 860 MHz, please order and use adapter BN 715010			
Frequency range		0 - 860 MHz			
VSWR (optimized to selected frequency range)		≤1.04 @ DC - 108 MHz or ≤1.04 @ 108 - 470 MHz or ≤1.04 @ 470 - 860 MHz or ≤1.08 @ DC - 860 MHz			
Proof voltage		17 kV			
Mains		115 or 230 V (depending on model) / 50 - 60 Hz			
Power consumption		25 W (standby), 0.8 kW (full operation)		25 W (standby), 1.2 kW (full operation)	
Potential-free interlock contact		Max. 42.4 V AC / 60 V DC max. 1 A			
Noise level		0 dB - 79 dB (according pump and fan operation)			
Operation position		Horizontally – Air input and output must be free to allow air flow.			
Dimensions (L x D x H) mm		775 x 462 x 815		826 x 687 x 1311	
Weight		BN 546423 BN 546423C0001	≈ 85 kg	BN 546404C0200 BN 546404C0201	≈ 130 kg ≈ 140 kg
Coolant		SPINNER cooling liquid BN A75272 (25l canister)		SPINNER cooling liquid BN A74423 (30l canister)	
Environmental conditions		For limitations other than above see „Environmental Conditions for Broadcast Products“.			
Ambient temperature		-10 °C ≤ θ ≤ +45 °C			
Storage temperature		-20 °C ≤ θ ≤ +70 °C			

25 kW Smart Loads with Separate Cooler

- Coaxial load and cooler with intelligent control
- Pump and fan only activated when needed
 absorbed RF power < 80 W: passive cooling
 absorbed RF power 80 W – 800 W: pump only
 absorbed RF power > 800 W: pump and fan
- Full power allowed from standby
- Potential-free interlock for fast self protection
- Low return loss
- 115 V or 230 V single phase mains
- Outdoor cooler to reduce room temperature



Smart load without cooler



Smart load with outdoor cooler, hoses and cables for 20 m spacing included

Part Number	BN 546418 Smart Load without Cooler	BN 546435C0200 230 V, 50 - 60 Hz BN 546435C0201 115 V, 50 - 60 Hz Smart Load with External Cooler
Average power Pulse power	25 kW On request	25 kW On request
Connector	3 1/8" EIA, facing upwards 4 1/2" EIA necessary for P ≥ 23 kW @ 470 to 860 MHz, please order and use adapter BN 715010 .	
Frequency range	0 - 860 MHz	
VSWR (optimized to selected frequency range)	≤1.04 @ DC to 108 MHz or ≤1.04 @ 108 to 470 MHz or ≤1.04 @ 470 to 860 MHz or ≤1.08 @ DC to 860 MHz	
Proof voltage	17 kV	
Mains	5 – 30 V DC, 100 mA for temperature sensor	115 or 230 V (depending on model) / 50 - 60 Hz
Power consumption	–	25 W (standby), 1.5 kW (full operation)
Potential-free interlock contact	–	Max. 42.4 V AC / 60 V DC max. 1 A
Temperature alarm	DC signal via fast responding electronic temperature sensor	–
Noise level		0 dB - 65 dB (according pump and fan operation)
Operation position	Any	Horizontally – Air input and output must be free to allow air flow.
Dimensions (L x D x H) mm	417 x 130 x 130	Indoor unit: 600 x 670 x 1182 Outdoor unit: 1088 x 569 x 753
Weight	≈ 7 kg	≈ 200 kg
Coolant flow rate input temperature interface	≥ 33.5 l/ min ≤ 70 °C Hose connection for 1" inner diameter	–
Coolant (for cooling circuits with aluminum)	SPINNER cooling liquid BN A74423 (30l canister)	
Environmental conditions	For limitations other than above see „Environmental Conditions for Broadcast Products“.	
Ambient temperature indoor units	-10 °C ≤ θ ≤ +45 °C	
Ambient temperat. external cooler	-20 °C ≤ θ ≤ +45 °C (with coolant A74423)	
Storage temperature	-25 °C ≤ θ ≤ +70 °C	

50 kW Smart Loads

- Coaxial load and cooler with intelligent control
- Pump and fan only activated when needed
 absorbed RF power < 80 W: passive cooling
 absorbed RF power 80 W – 800 W: pump only
 absorbed RF power > 800 W: pump and fan
- Full power allowed from standby
- Potential-free interlock for fast self protection
- Low return loss
- 115 V or 230 V single phase mains
- Integrated cooler or outdoor cooler to reduce room temperature



Smart load without cooler



Smart load with cooler



Smart load with outdoor cooler, hoses and cables for 20 m spacing included

Part Number	BN 546438 Smart Load without Cooler	BN 546437C0200 Smart Load with Integrated Cooler	BN 546430C0200 Smart Load with External Cooler
Average power Pulse power	50 kW On request		
Connector	6 1/8" EIA	6 1/8" EIA, facing upwards	
Frequency range	0 ≤ f ≤ 790 MHz		
VSWR (optimized to selected frequency range)	≤1.04 @ DC to 108 MHz or ≤1.04 @ 108 to 470 MHz or ≤1.04 @ 470 to 790 MHz or ≤1.08 @ DC to 790 MHz		
Proof voltage	17 kV		
Mains	5 – 30 V DC, 100 mA for temperature sensor	230 VAC / 50 – 60 Hz	
Power consumption	–	25 W (standby), 3.0 kW (full operation)	
Potential-free interlock contact	–	Max. 42.4 V AC / 60 V DC max. 1 A	
Temperature alarm	DC signal via fast responding electronic temperature sensor	–	
Noise level	–	0 dB - 85 dB (according pump and fan)	0 dB - 65 dB (according pump and fan)
Operation position	Any	Horizontally – Air input and output must be free to allow air flow.	
Dimensions (L x D x H) mm	671 x 207 x 207	964 x 779 x 1348	Indoor unit: 600 x 670 x 1383 Outdoor unit: 1400 x 650 x 1153
Weight	≈ 15 kg	≈ 190 kg	≈ 290 kg
Coolant flow rate input temperature interface	≥ 60 l/ min ≤ 70 °C Hose connection for 1" inner diameter	–	
Coolant (for cooling circuits with aluminum)	SPINNER cooling liquid BN A74423 (30l canister)		
Environmental conditions	For limitations other than above see „Environmental Conditions for Broadcast Products“.		
Ambient temperature indoor units	-10 °C ≤ θ ≤ +45 °C		
Ambient temperat. external cooler	-20 °C ≤ θ ≤ +45 °C (with coolant A74423)		
Storage temperature	-20 °C ≤ θ ≤ +70 °C		

Environmental Conditions for Broadcast Products (TD-00060)

The environmental conditions for broadcast products are applicable if not stated otherwise at the individual product page.

Products	Combiners, Filters	Patch Panels, Switches, Coaxial Rigid Line Components
Operational conditions	ETSI EN 300 019-1-3 V2.3.2 (2009-1) class 3.1 N	
Ambient temperature	-10 °C ≤ θ ≤ +45 °C	
Condensation	Not allowed	
Relative humidity	≤ 95 %	
Derating of input power with increasing altitude	<p>The maximum input power can be applied up to 2286 m or 7500 ft above sea level unless noted otherwise in the data sheet. Above this height the maximum input power must be reduced as shown in the diagram.</p>	<p>The maximum input power can be applied up to 500 m or 1600 ft above sea level unless noted otherwise in the data sheet. Above this height the maximum input power must be reduced as shown in the diagram.</p>
Derating of voltage with increasing altitude	Included in the derating of input power	<p>The maximum voltage can be applied up to 500 m or 1600 ft above sea level unless noted otherwise in the data sheet. Above this height the voltage must be reduced as shown in the diagram.</p>
Transport conditions	ETSI EN 300 019-1-2 V2.1.4 (2003-04) class 2.2	
Ambient temperature	-25 °C ≤ θ ≤ +70 °C	
Rain, condensation, icing	Not allowed	
Storage conditions	ETSI EN 300 019-1-1 V2.1.4 (2003-04) class 1.2	
Ambient temperature	-10 °C ≤ θ ≤ +45 °C	
Rain, condensation, icing	Not allowed	
Safety	EN 60215 (1994) / IEC 215 (1993)	



HIGH FREQUENCY PERFORMANCE WORLDWIDE

SPINNER designs and builds cutting-edge radio frequency systems, setting performance and longevity standards for others to follow. The company's track record of innovation dates back to 1946, and many of today's mainstream products are rooted in SPINNER inventions.

Industry leaders continue to count on SPINNER's engineering excellence to drive down their costs of service and ownership with premium-quality, off-the-shelf products and custom solutions. Headquartered in Munich, Germany, the global frontrunner in RF components remains the first choice in simple-yet-smart RF solutions.

www.spinner-group.com

SPINNER GmbH

Headquarters

Erzgiessereistr. 33
80335 Munich

GERMANY

Phone: +49 89 12601-0
Fax: +49 89 12601-1292
info@spinner-group.com

SPINNER Austria GmbH

Triester Str. 190
1230 Vienna

AUSTRIA

Phone: +43 1 66277 51
Fax: +43 1 66277 5115
info-austria@spinner-group.com

SPINNER Electrotécnica S.L.

c/ Perú, 4 – Local nº 15
28230 Las Rozas (Madrid)

SPAIN

Phone: +34 91 6305 842
Fax: +34 91 6305 838
info-iberia@spinner-group.com

OOO SPINNER Elektrotechnik

22 km Kievskoe Shosse House 4
Bld. 2, Office 405G
108811 Moscow

RUSSIA

Phone: +7 495 638 5321
Fax: +7 495 240 5889
info-russia@spinner-group.com

SPINNER France S.A.R.L.

24 Rue Albert Priolet
78100 St. Germain en Laye

FRANCE

Phone: +33 1 74 13 85 24
info-france@spinner-group.com

SPINNER ICT Inc.

2220 Northmont Parkway, 250
Duluth, GA 30096

USA

Phone: +1 770 2636 326
info@spinner-group.com

SPINNER Nordic AB

Kråketorpsgatan 20
43153 Mölndal

SWEDEN

Phone: +46 31 7061670
Fax: +46 31 7061679
info-nordic@spinner-group.com

SPINNER Telecommunication

Devices (Shanghai) Co., Ltd.
351 Lian Yang Road
Songjiang Industrial Zone
Shanghai 201613

P.R. CHINA

Phone: +86 21 577 45377
Fax: +86 21 577 40962
info-china@spinner-group.com

SPINNER UK Ltd.

Suite 8 Phoenix House
Golborne Enterprise Park,
High Street
Golborne, Warrington
WA3 3DP

UNITED KINGDOM

Phone: +44 1942 275222
Fax: +44 1942 275221
info-uk@spinner-group.com