

PART NUMBER	DESCRIPTION
CCS-32	Commercial Latching SPDT, DC-12GHz
CS-32	Elite Latching SPDT, DC-12GHz

The CCS-32/CS-32 is a broadband, SPDT, electromechanical, coaxial switch designed to switch a microwave signal from a common input to either of two outputs. The characteristic impedance is 50 Ohms. The small switches incorporate Type N or TNC connectors. The CCS-32/CS-32 series switch is offered with a latching actuator. This design is compatible with the two most common mounting hole patterns. The CCS-32/CS-32 series switch is interchangeable with a variety of switches.



ENVIRONMENTAL AND PHYSICAL CHARACTERISTICS	
Operating Temperature	
Commercial Model, CCS-32	-25°C to 65°C
Elite Model, CS-32	-55°C to 85°C
Vibration (MIL-STD-202 Method 214, Condition D, non-operating)	10 g's RMS
Shock (MIL-STD-202 Method 213, Condition D, non-operating)	500 g's
Standard Actuator Life	2,000,000 cycles
Actuator Life w/ Additional Features	1,000,000 cycles
Connector Type	Type N or TNC
Humidity (Moisture Seal)	Available
Weight	6 oz. (170.1g) (max.)

ELECTRICAL CHARACTERISTICS	
Form Factor	SPDT, break before make
Frequency Range	
CCS-32	DC-12 GHz
CS-32	DC-12 GHz
Characteristic Impedance	50 Ohms
Operate Time	20 ms (max.)
Actuation Voltage Available	12 15 24 28 V
Actuation Current, max. @ ambient	150 120 70 60 mA
HIGH POWER (HN & HT) CONNECTORS ONLY	
Reference RF Power Handling	1.1 kW CW @ 1.1 GHz

TYPICAL PERFORMANCE CHARACTERISTICS: N CONNECTOR OPTION (TNC CONNECTOR, 11GHz MAX.)				
Frequency	DC-1 GHz	1-4 GHz	4-10 GHz	10-12 GHz
Insertion Loss, dB, max.	0.3	0.4	0.5	0.5
Isolation, dB, min.	70	60	60	50
VSWR, max.	1.25:1	1.4:1	1.7:1	1.7:1

For maximum limits, please see charts on page 3-5

PART NUMBERING SYSTEM

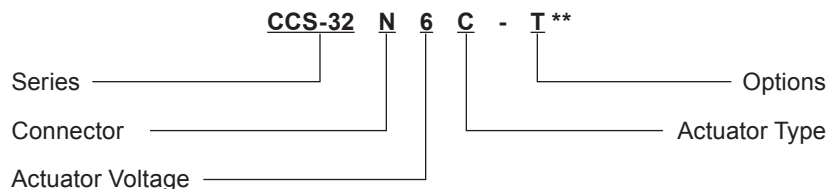

Connector
N: Type N Female
T: TNC Female
HN: High Power Type N Female
HT: High Power TNC Female

Actuator Voltage
6: 28 Vdc Latching
7: 15 Vdc Latching
8: 12 Vdc Latching
9: 24 Vdc Latching

Actuator Type
0: Standard Contacts
C: Indicator Contacts
D: Self Cutoff Only
E: Indicators and Self Cutoff

Options
T: TTL Drivers with Diodes
D: Transient Suppression Diodes
R: Positive + Common
M: Moisture Seal
S: 9 Pin D-Sub Connector

**SEE PARTS LIST ON PAGES 8-9

For other options, contact factory.

Series CCS-32/CS-32

DC-12 GHz

Latching SPDT Coaxial Switch



SCHEMATICS AND MECHANICAL OUTLINE

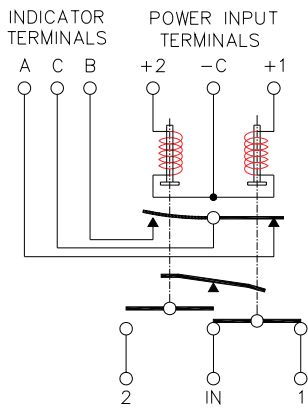

Indicators

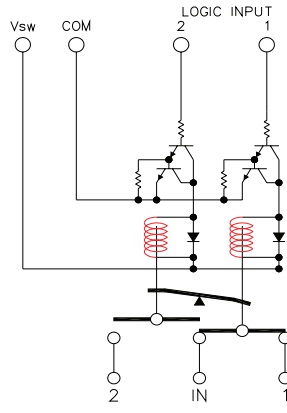

TTL

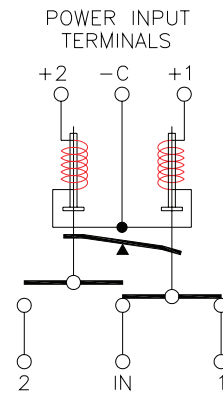

Analog

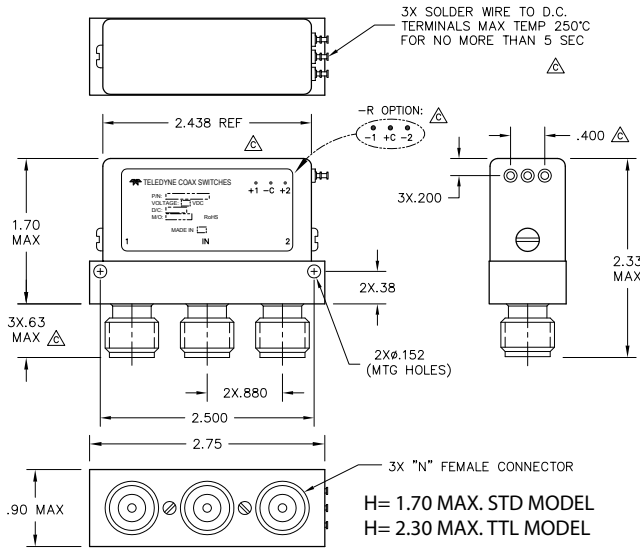

N Type Outline

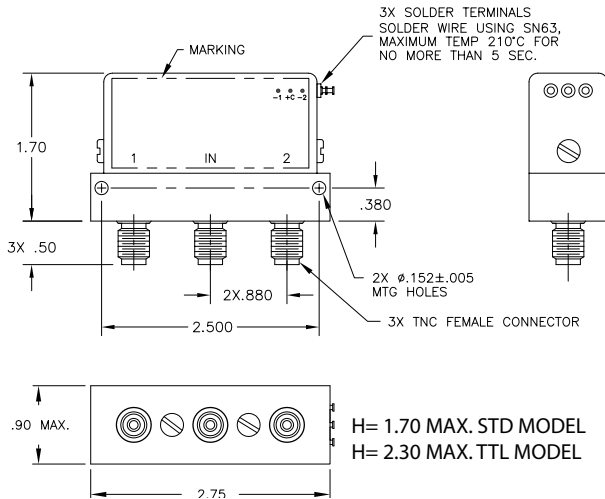

TNC Outline

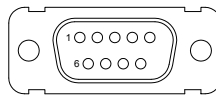

"S OPTION" 9-PIN D-SUB CONNECTOR (EXAMPLE: CCS-32N60-S)

9 PIN D-SUB PINOUT FOR LATCHING SPDT				
OPTIONS				
Pin No.	Basic	Indicators	TTL	Indicators & TTL
1	1	1		
2	2	2		
3	C	C	Common	Common
4			1	1
5			2	2
6			Vsw	Vsw
7		A		A
8		B		B
9		C		C

TRUTH TABLE (with TTL option)					
Logic Input		RF Path		Indicator (if applicable)	
1	2	IN to 1	IN to 2	A	B
0	0	No Change			
1	0	On	Off	C	0
0	1	Off	On	0	C
1	1	Forbidden			

TYPICAL NARROWBAND RF INSERTION LOSS PERFORMANCE CURVES

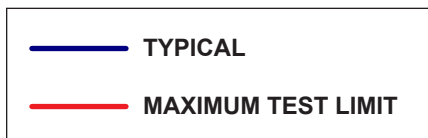
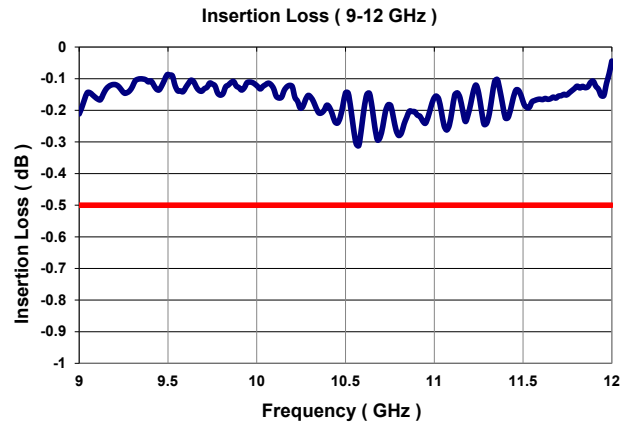
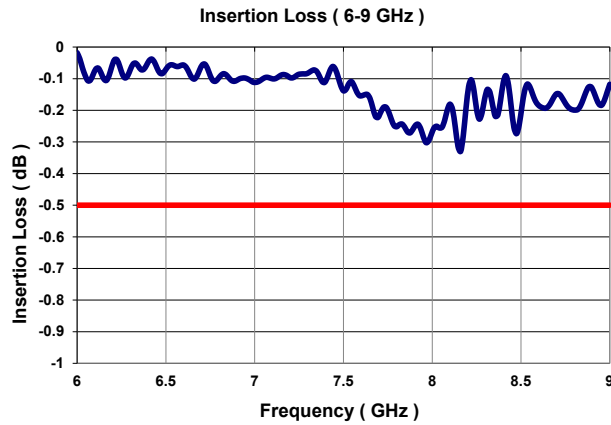
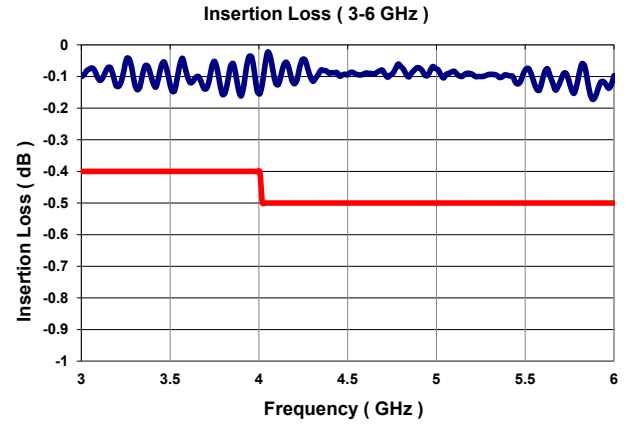
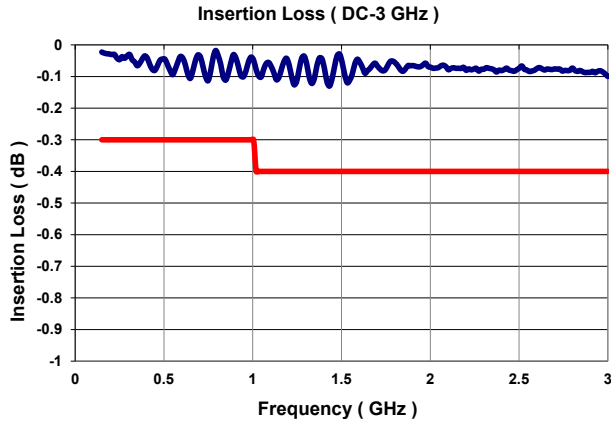

TYPICAL NARROWBAND RF ISOLATION PERFORMANCE CURVES

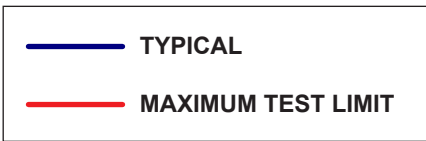
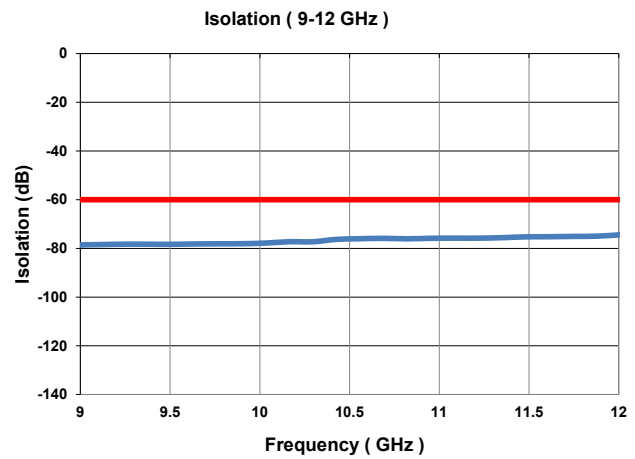
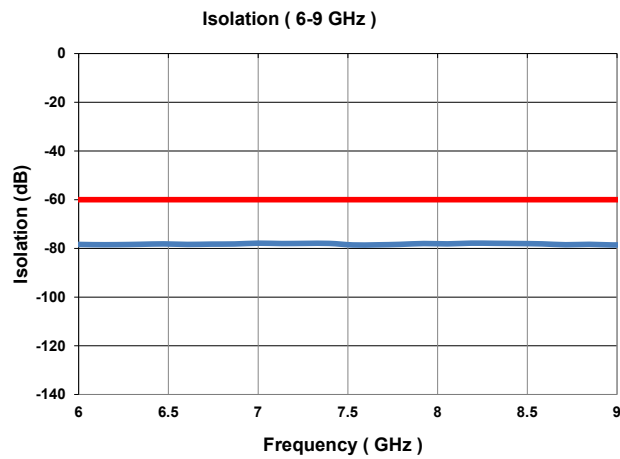
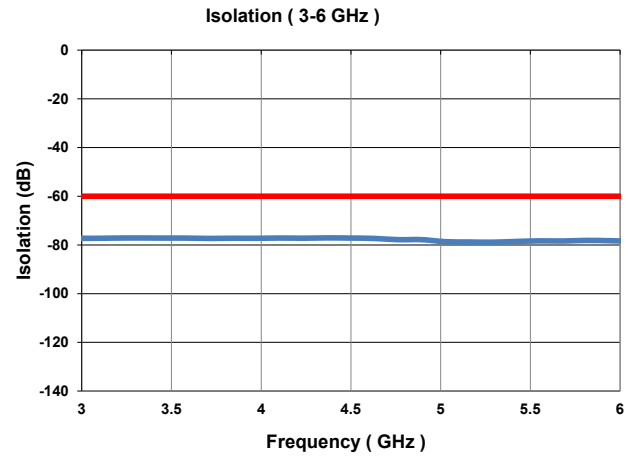
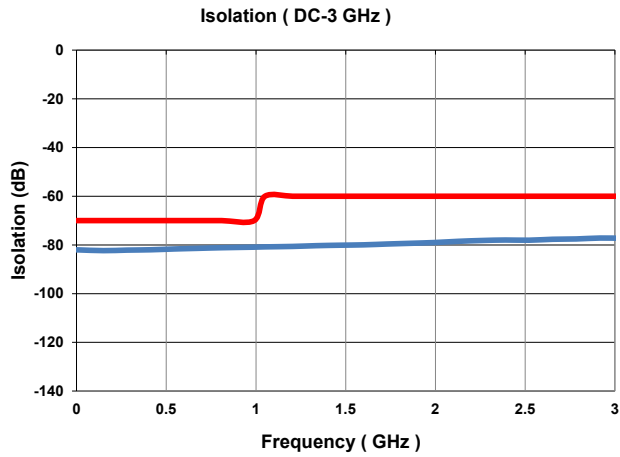

TYPICAL NARROWBAND RF VSWR PERFORMANCE CURVES

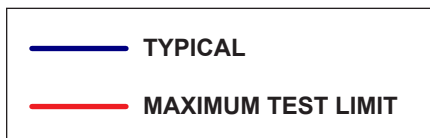
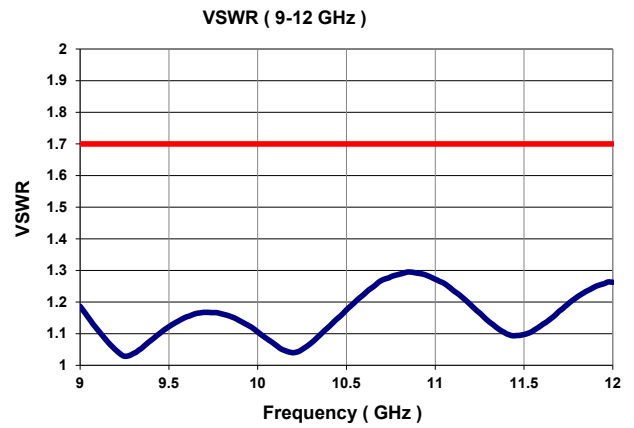
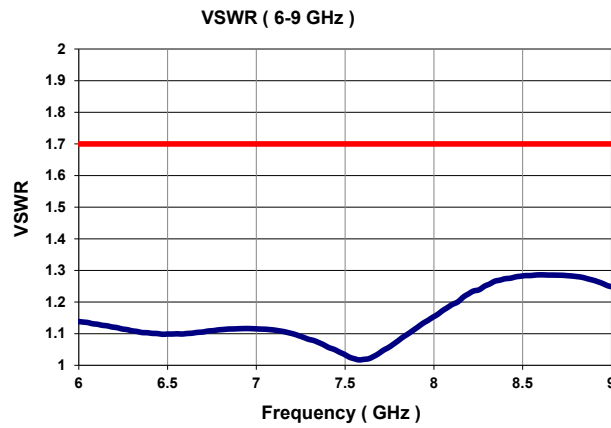
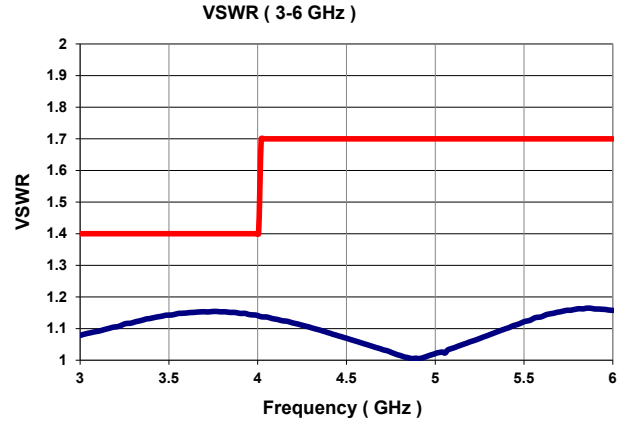
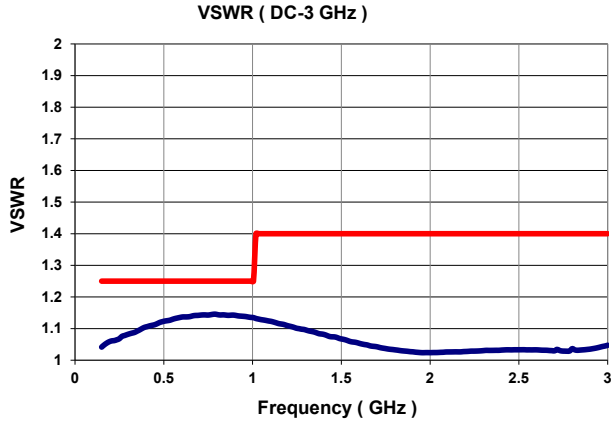

TYPICAL POWER PERFORMANCE CURVE

Power Handling vs. Frequency

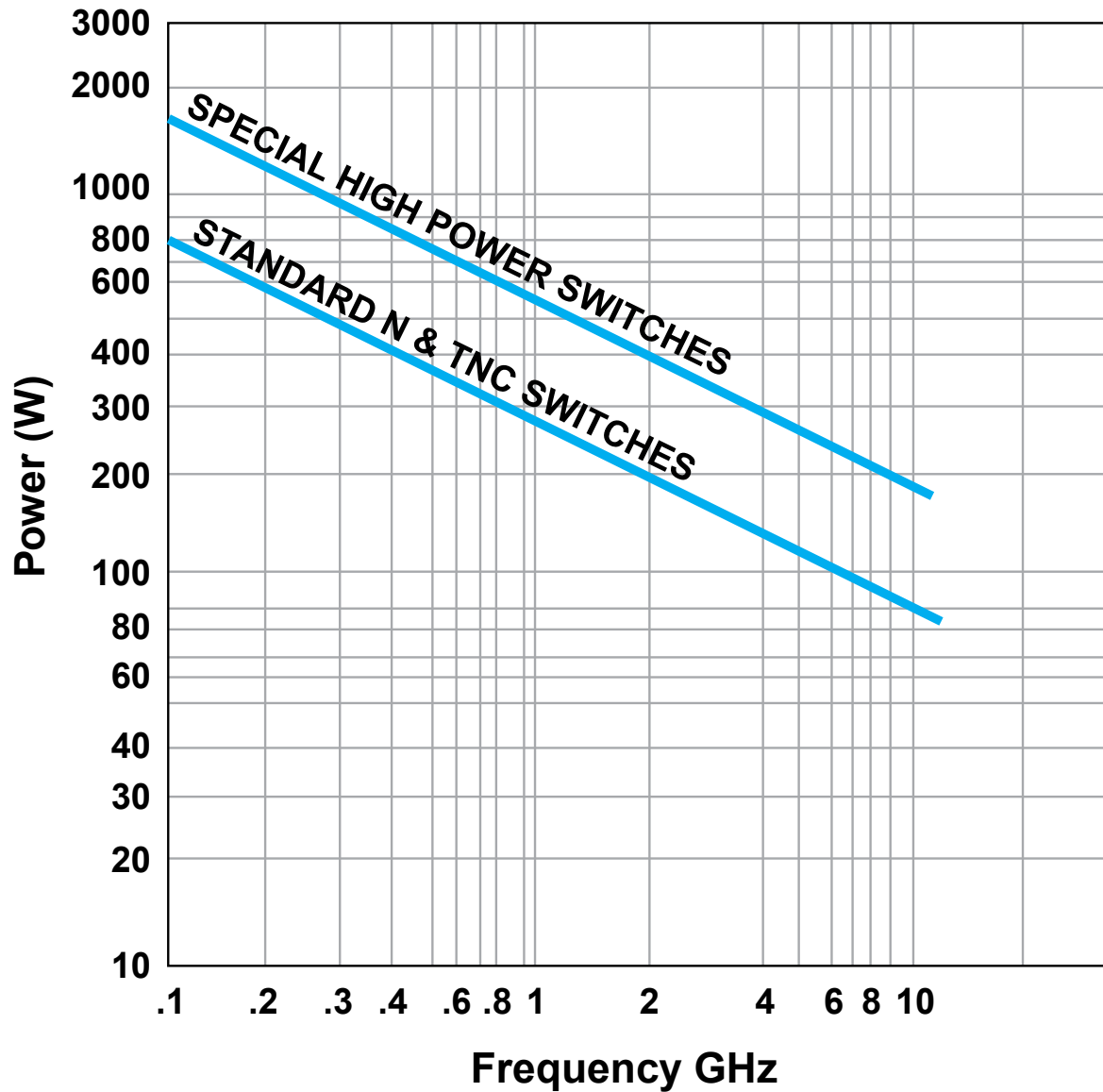

Estimates based on the following reference conditions:

- Ambient temperature of 40°C or less
- Sea level operation
- Load VSWR of 1.20:1 maximum
- No high-power (hot) switching

Please contact Teledyne Coax Switches for derating factors when applications do not meet the foregoing reference conditions.

GLOSSARY

Actuator

An actuator is the electromechanical mechanism that transfers the RF contacts from one position to another upon DC command.

Arc Suppression Diode

A diode is connected in parallel with the coil. This diode limits the “reverse EMF spike” generated when the coil de-energizes to 0.7 volts. The diode cathode is connected to the positive side of the coil and the anode is connected to the negative side.

Date Code

All switches are marked with either a unique serial number or a date code. Date codes are in accordance with MIL-STD-1285 Paragraph 5.2.5 and consist of four digits. The first two digits define the year and the last two digits define the week of the year (YYWW). Thus, 1032 identifies switches that passed through final inspection during the 32nd week of 2010.

Latching

A latching switch remains in the selected position whether or not voltage is maintained. This can be accomplished with either a magnetic or mechanical latching mechanism.

Indicator

Indicators tell the system which position the switch is in. Other names for indicators are telemetry contacts or tellback circuit. Indicators are usually a set of internally mounted DC contacts linked to the actuator. They can be wired to digital input lines, status lights, or interlocks. Unless otherwise specified, the maximum indicator contact rating is 30 Vdc, 50 mA, or 1.5 Watts into a resistive load.

Isolation

Isolation is the measure of the power level at the output connector of an unconnected RF channel as referenced to the power at the input connector. It is specified in dB below the input power level.

Self-Cutoff

The self-cutoff option disables the actuator current on completion of actuation. Either a series contact (linked to the actuator) or an IC driver circuit provides the current cutoff. This option results in minimum power consumption by the RF switch. Cutthroat is another name used in the industry for this option. Pulse latching is a term used to describe a switch without this feature.

SPDT Switch

A single-pole double-throw, bi-directional switch that can be used as having one input and two outputs or two inputs and one output.

Switching Time

Switching time is the total interval beginning with the arrival of the leading edge of the command pulse at the switch DC input and ending with the completion of the switch transfer,

including contact bounce. It consists of three parts: (1) inductive delay in the coil, (2) transfer time of the physical movement of the contacts, and (3) the bounce time of the RF contacts.

TTL Switch Driver Option

As a special option, switch drivers can be provided for both failsafe and latching switches, which are compatible with industry-standard low-power Schottky TTL circuits.

Performance Parameters vs Frequency

Generally speaking, the RF performance of coaxial switches is frequency dependent. With increasing frequency, VSWR and insertion loss increase while isolation decreases. All data sheets specify these three parameters as “worst case” at the highest operating frequency. If the switch is to be used over a narrow frequency band, better performance can be achieved.

Actuator Current vs Temperature

The resistance of the actuator coil varies as a function of temperature. There is an inverse relationship between the operating temperature of the switch and the actuator drive current. For switches operating at 28 VDC, the approximate actuator drive current at temperature, T, can be calculated using the equation:

$$I_T = \frac{I_A}{[1 + .00385 (T-20)]}$$

Where:

I_T = Actuator current at temperature, T

I_A = Room temperature actuator current – see data sheet

T = Temperature of interest in °C

Magnetic Sensitivity

An electro-mechanical switch can be sensitive to ferrous materials and external magnetic fields. Neighboring ferrous materials should be permitted no closer than 0.5 inches and adjacent external magnetic fields should be limited to a flux density of less than 5 Gauss.

SPECIAL FEATURE

Switching High-Power or Highly Sensitive Signals

Ensure the most linear response with the best galvanically matched contact system in the industry. Extremely low passive intermodulation is standard on all of our switches.

Carrier Frequency 1	Carrier Frequency 2	PIM 3rd Order Frequency	PIM 5th Order Frequency
870 MHz	893 MHz	847 MHz	824 MHz

	3rd Order Intermodulation	5th Order Intermodulation
SPDT	-91 dBm	-110 dBm
	-134 dBc	-153 dBc

Series CCS-32/CS-32

DC-12 GHz

Latching SPDT Coaxial Switch



TELEDYNE
COAX SWITCHES
Everywhereyoulook™

LATCHING CCS-32N/CS-32N • CCS-32T/CS-32T PART NUMBER LIST

	PART No.		PART No.		PART No.		PART No.
1	CCS-32NXC	43	CCS-32NX0	85	CS-32NXD-MS	127	CCS-32TXC-DM
2	CCS-32NXC-D	44	CCS-32NX0-D	86	CS-32NXD-R	128	CCS-32TXC-DMS
3	CCS-32NXC-DM	45	CCS-32NX0-DM	87	CS-32NXD-RM	129	CCS-32TXC-DR
4	CCS-32NXC-DMS	46	CCS-32NX0-DMS	88	CS-32NXD-RMS	130	CCS-32TXC-DRM
5	CCS-32NXC-DR	47	CCS-32NX0-DR	89	CS-32NXD-RS	131	CCS-32TXC-DRMS
6	CCS-32NXC-DRM	48	CCS-32NX0-DRM	90	CS-32NXD-S	132	CCS-32TXC-DRS
7	CCS-32NXC-DRMS	49	CCS-32NX0-DRMS	91	CS-32NXD-T	133	CCS-32TXC-DS
8	CCS-32NXC-DRS	50	CCS-32NX0-DRS	92	CS-32NXD-TM	134	CCS-32TXC-M
9	CCS-32NXC-DS	51	CCS-32NX0-DS	93	CS-32NXD-TMS	135	CCS-32TXC-MS
10	CCS-32NXC-M	52	CCS-32NX0-M	94	CS-32NXE	136	CCS-32TXC-R
11	CCS-32NXC-MS	53	CCS-32NX0-MS	95	CS-32NXE-M	137	CCS-32TXC-RM
12	CCS-32NXC-R	54	CCS-32NX0-R	96	CS-32NXE-MS	138	CCS-32TXC-RMS
13	CCS-32NXC-RM	55	CCS-32NX0-RM	97	CS-32NXE-R	139	CCS-32TXC-RS
14	CCS-32NXC-RMS	56	CCS-32NX0-RMS	98	CS-32NXE-RM	140	CCS-32TXC-S
15	CCS-32NXC-RS	57	CCS-32NX0-RS	99	CS-32NXE-RMS	141	CCS-32TXC-T
16	CCS-32NXC-S	58	CCS-32NX0-S	100	CS-32NXE-RS	142	CCS-32TXC-TM
17	CCS-32NXC-T	59	CCS-32NX0-T	101	CS-32NXE-S	143	CCS-32TXC-TMS
18	CCS-32NXC-TM	60	CCS-32NX0-TM	102	CS-32NXE-T	144	CCS-32TXC-TS
19	CCS-32NXC-TMS	61	CCS-32NX0-TMS	103	CS-32NXE-TM	145	CCS-32TXD
20	CCS-32NXC-TS	62	CCS-32NX0-TS	104	CS-32NXE-TMS	146	CCS-32TXD-M
21	CCS-32NXD	63	CS-32NXC	105	CS-32NX0	147	CCS-32TXD-MS
22	CCS-32NXD-M	64	CS-32NXC-D	106	CS-32NX0-D	148	CCS-32TXD-R
23	CCS-32NXD-MS	65	CS-32NXC-DM	107	CS-32NX0-DM	149	CCS-32TXD-RM
24	CCS-32NXD-R	66	CS-32NXC-DMS	108	CS-32NX0-DMS	150	CCS-32TXD-RMS
25	CCS-32NXD-RM	67	CS-32NXC-DR	109	CS-32NX0-DR	151	CCS-32TXD-RS
26	CCS-32NXD-RMS	68	CS-32NXC-DRM	110	CS-32NX0-DRM	152	CCS-32TXD-S
27	CCS-32NXD-RS	69	CS-32NXC-DRMS	111	CS-32NX0-DRMS	153	CCS-32TXD-T
28	CCS-32NXD-S	70	CS-32NXC-DRS	112	CS-32NX0-DRS	154	CCS-32TXD-TM
29	CCS-32NXD-T	71	CS-32NXC-DS	113	CS-32NX0-DS	155	CCS-32TXD-TMS
30	CCS-32NXD-TM	72	CS-32NXC-M	114	CS-32NX0-M	156	CCS-32TXE
31	CCS-32NXD-TMS	73	CS-32NXC-MS	115	CS-32NX0-MS	157	CCS-32TXE-M
32	CCS-32NXE	74	CS-32NXC-R	116	CS-32NX0-R	158	CCS-32TXE-MS
33	CCS-32NXE-M	75	CS-32NXC-RM	117	CS-32NX0-RM	159	CCS-32TXE-R
34	CCS-32NXE-MS	76	CS-32NXC-RMS	118	CS-32NX0-RMS	160	CCS-32TXE-RM
35	CCS-32NXE-R	77	CS-32NXC-RS	119	CS-32NX0-RS	161	CCS-32TXE-RMS
36	CCS-32NXE-RM	78	CS-32NXC-S	120	CS-32NX0-S	162	CCS-32TXE-RS
37	CCS-32NXE-RMS	79	CS-32NXC-T	121	CS-32NX0-T	163	CCS-32TXE-S
38	CCS-32NXE-RS	80	CS-32NXC-TM	122	CS-32NX0-TM	164	CCS-32TXE-T
39	CCS-32NXE-S	81	CS-32NXC-TMS	123	CS-32NX0-TMS	165	CCS-32TXE-TM
40	CCS-32NXE-T	82	CS-32NXC-TS	124	CS-32NX0-TS	166	CCS-32TXE-TMS
41	CCS-32NXE-TM	83	CS-32NXD	125	CCS-32TXC	167	CCS-32TX0
42	CCS-32NXE-TMS	84	CS-32NXD-M	126	CCS-32TXC-D	168	CCS-32TX0-D

* X = 6 (28Vdc), 7 (15Vdc), 8 (12Vdc) and 9 (24Vdc)

LATCHING CCS-32N/CS-32N • CCS-32T/CS-32T PART NUMBER LIST

	PART No.		PART No.		PART No.		PART No.
169	CCS-32TXO-DM	211	CS-32TXD-RM	253	CCS-32HNXC-DR	295	CCS-32HNXO
170	CCS-32TXO-DMS	212	CS-32TXD-RMS	254	CCS-32HNXC-DRM	296	CCS-32HNXO-D
171	CCS-32TXO-DR	213	CS-32TXD-RS	255	CCS-32HNXC-DRMS	297	CCS-32HNXO-DM
172	CCS-32TXO-DRM	214	CS-32TXD-S	256	CCS-32HNXC-DRS	298	CCS-32HNXO-DMS
173	CCS-32TXO-DRMS	215	CS-32TXD-T	257	CCS-32HNXC-DS	299	CCS-32HNXO-DR
174	CCS-32TXO-DRS	216	CS-32TXD-TM	258	CCS-32HNXC-M	300	CCS-32HNXO-DRM
175	CCS-32TXO-DS	217	CS-32TXD-TMS	259	CCS-32HNXC-MS	301	CCS-32HNXO-DRMS
176	CCS-32TXO-M	218	CS-32TXE	260	CCS-32HNXC-R	302	CCS-32HNXO-DRS
177	CCS-32TXO-MS	219	CS-32TXE-M	261	CCS-32HNXC-RM	303	CCS-32HNXO-DS
178	CCS-32TXO-R	220	CS-32TXE-MS	262	CCS-32HNXC-RMS	304	CCS-32HNXO-M
179	CCS-32TXO-RM	221	CS-32TXE-R	263	CCS-32HNXC-RS	305	CCS-32HNXO-MS
180	CCS-32TXO-RMS	222	CS-32TXE-RM	264	CCS-32HNXC-S	306	CCS-32HNXO-R
181	CCS-32TXO-RS	223	CS-32TXE-RMS	265	CCS-32HNXC-T	307	CCS-32HNXO-RM
182	CCS-32TXO-S	224	CS-32TXE-RS	266	CCS-32HNXC-TM	308	CCS-32HNXO-RMS
183	CCS-32TXO-T	225	CS-32TXE-S	267	CCS-32HNXC-TMS	309	CCS-32HNXO-RS
184	CCS-32TXO-TM	226	CS-32TXE-T	268	CCS-32HNXC-TS	310	CCS-32HNXO-S
185	CCS-32TXO-TMS	227	CS-32TXE-TM	269	CCS-32HNXD	311	CCS-32HNXO-T
186	CCS-32TXO-TS	228	CS-32TXE-TMS	270	CCS-32HNXD-M	312	CCS-32HNXO-TM
187	CS-32TXC	229	CS-32TXO	271	CCS-32HNXD-MS	313	CCS-32HNXO-TMS
188	CS-32TXC-D	230	CS-32TXO-D	272	CCS-32HNXD-R	314	CCS-32HNXO-TS
189	CS-32TXC-DM	231	CS-32TXO-DM	273	CCS-32HNXD-RM	315	CS-32HNXC
190	CS-32TXC-DMS	232	CS-32TXO-DMS	274	CCS-32HNXD-RMS	316	CS-32HNXC-D
191	CS-32TXC-DR	233	CS-32TXO-DR	275	CCS-32HNXD-RS	317	CS-32HNXC-DM
192	CS-32TXC-DRM	234	CS-32TXO-DRM	276	CCS-32HNXD-S	318	CS-32HNXC-DMS
193	CS-32TXC-DRMS	235	CS-32TXO-DRMS	277	CCS-32HNXD-T	319	CS-32HNXC-DR
194	CS-32TXC-DRS	236	CS-32TXO-DRS	278	CCS-32HNXD-TM	320	CS-32HNXC-DRM
195	CS-32TXC-DS	237	CS-32TXO-DS	279	CCS-32HNXD-TMS	321	CS-32HNXC-DRMS
196	CS-32TXC-M	238	CS-32TXO-M	280	CCS-32HNXE	322	CS-32HNXC-DRS
197	CS-32TXC-MS	239	CS-32TXO-MS	281	CCS-32HNXE-M	323	CS-32HNXC-DS
198	CS-32TXC-R	240	CS-32TXO-R	282	CCS-32HNXE-MS	324	CS-32HNXC-M
199	CS-32TXC-RM	241	CS-32TXO-RM	283	CCS-32HNXE-R	325	CS-32HNXC-MS
200	CS-32TXC-RMS	242	CS-32TXO-RMS	284	CCS-32HNXE-RM	326	CS-32HNXC-R
201	CS-32TXC-RS	243	CS-32TXO-RS	285	CCS-32HNXE-RMS	327	CS-32HNXC-RM
202	CS-32TXC-S	244	CS-32TXO-S	286	CCS-32HNXE-RS	328	CS-32HNXC-RMS
203	CS-32TXC-T	245	CS-32TXO-T	287	CCS-32HNXE-S	329	CS-32HNXC-RS
204	CS-32TXC-TM	246	CS-32TXO-TM	288	CCS-32HNXE-T	330	CS-32HNXC-S
205	CS-32TXC-TMS	247	CS-32TXO-TMS	289	CCS-32HNXE-TM	331	CS-32HNXC-T
206	CS-32TXC-TS	248	CS-32TXO-TS	290	CCS-32HNXE-TMS	332	CS-32HNXC-TM
207	CS-32TXD	249	CCS-32HNXC	291	CCS-32HNXO	333	CS-32HNXC-TMS
208	CS-32TXD-M	250	CCS-32HNXC-D	292	CCS-32HNXO-D	334	CS-32HNXC-TS
209	CS-32TXD-MS	251	CCS-32HNXC-DM	293	CCS-32HNXO-DM	335	CS-32HNXD
210	CS-32TXD-R	252	CCS-32HNXC-DMS	294	CCS-32HNXO-DMS	336	CS-32HNXD-M

* X = 6 (28Vdc), 7 (15Vdc), 8 (12Vdc) and 9 (24Vdc)

Series CCS-32/CS-32

DC-12 GHz

Latching SPDT Coaxial Switch



TELEDYNE
COAX SWITCHES
Everywhereyoulook™

LATCHING CCS-32N/CS-32N • CCS-32T/CS-32T PART NUMBER LIST

	PART No.		PART No.		PART No.		PART No.
337	CS-32HNXD-MS	379	CCS-32HTXC-DM	421	CCS-32HTXO-DM	463	CS-32HTXD-RM
338	CS-32HNXD-R	380	CCS-32HTXC-DMS	422	CCS-32HTXO-DMS	464	CS-32HTXD-RMS
339	CS-32HNXD-RM	381	CCS-32HTXC-DR	423	CCS-32HTXO-DR	465	CS-32HTXD-RS
340	CS-32HNXD-RMS	382	CCS-32HTXC-DRM	424	CCS-32HTXO-DRM	466	CS-32HTXD-S
341	CS-32HNXD-RS	383	CCS-32HTXC-DRMS	425	CCS-32HTXO-DRMS	467	CS-32HTXD-HT
342	CS-32HNXD-S	384	CCS-32HTXC-DRS	426	CCS-32HTXO-DRS	468	CS-32HTXD-HTM
343	CS-32HNXD-T	385	CCS-32HTXC-DS	427	CCS-32HTXO-DS	469	CS-32HTXD-HTMS
344	CS-32HNXD-TM	386	CCS-32HTXC-M	428	CCS-32HTXO-M	470	CS-32HTXE
345	CS-32HNXD-TMS	387	CCS-32HTXC-MS	429	CCS-32HTXO-MS	471	CS-32HTXE-M
346	CS-32HNXE	388	CCS-32HTXC-R	430	CCS-32HTXO-R	472	CS-32HTXE-MS
347	CS-32HNXE-M	389	CCS-32HTXC-RM	431	CCS-32HTXO-RM	473	CS-32HTXE-R
348	CS-32HNXE-MS	390	CCS-32HTXC-RMS	432	CCS-32HTXO-RMS	474	CS-32HTXE-RM
349	CS-32HNXE-R	391	CCS-32HTXC-RS	433	CCS-32HTXO-RS	475	CS-32HTXE-RMS
350	CS-32HNXE-RM	392	CCS-32HTXC-S	434	CCS-32HTXO-S	476	CS-32HTXE-RS
351	CS-32HNXE-RMS	393	CCS-32HTXC-HT	435	CCS-32HTXO-HT	477	CS-32HTXE-S
352	CS-32HNXE-RS	394	CCS-32HTXC-HTM	436	CCS-32HTXO-HTM	478	CS-32HTXE-HT
353	CS-32HNXE-S	395	CCS-32HTXC-HTMS	437	CCS-32HTXO-HTMS	479	CS-32HTXE-HTM
354	CS-32HNXE-T	396	CCS-32HTXC-HTS	438	CCS-32HTXO-HTS	480	CS-32HTXE-HTMS
355	CS-32HNXE-TM	397	CCS-32HTXD	439	CS-32HTXC	481	CS-32HTXO
356	CS-32HNXE-TMS	398	CCS-32HTXD-M	440	CS-32HTXC-D	482	CS-32HTXO-D
357	CS-32HNXO	399	CCS-32HTXD-MS	441	CS-32HTXC-DM	483	CS-32HTXO-DM
358	CS-32HNXO-D	400	CCS-32HTXD-R	442	CS-32HTXC-DMS	484	CS-32HTXO-DMS
359	CS-32HNXO-DM	401	CCS-32HTXD-RM	443	CS-32HTXC-DR	485	CS-32HTXO-DR
360	CS-32HNXO-DMS	402	CCS-32HTXD-RMS	444	CS-32HTXC-DRM	486	CS-32HTXO-DRM
361	CS-32HNXO-DR	403	CCS-32HTXD-RS	445	CS-32HTXC-DRMS	487	CS-32HTXO-DRMS
362	CS-32HNXO-DRM	404	CCS-32HTXD-S	446	CS-32HTXC-DRS	488	CS-32HTXO-DRS
363	CS-32HNXO-DRMS	405	CCS-32HTXD-HT	447	CS-32HTXC-DS	489	CS-32HTXO-DS
364	CS-32HNXO-DRS	406	CCS-32HTXD-HTM	448	CS-32HTXC-M	490	CS-32HTXO-M
365	CS-32HNXO-DS	407	CCS-32HTXD-HTMS	449	CS-32HTXC-MS	491	CS-32HTXO-MS
366	CS-32HNXO-M	408	CCS-32HTXE	450	CS-32HTXC-R	492	CS-32HTXO-R
367	CS-32HNXO-MS	409	CCS-32HTXE-M	451	CS-32HTXC-RM	493	CS-32HTXO-RM
368	CS-32HNXO-R	410	CCS-32HTXE-MS	452	CS-32HTXC-RMS	494	CS-32HTXO-RMS
369	CS-32HNXO-RM	411	CCS-32HTXE-R	453	CS-32HTXC-RS	495	CS-32HTXO-RS
370	CS-32HNXO-RMS	412	CCS-32HTXE-RM	454	CS-32HTXC-S	496	CS-32HTXO-S
371	CS-32HNXO-RS	413	CCS-32HTXE-RMS	455	CS-32HTXC-HT	497	CS-32HTXO-HT
372	CS-32HNXO-S	414	CCS-32HTXE-RS	456	CS-32HTXC-HTM	498	CS-32HTXO-HTM
373	CS-32HNXO-T	415	CCS-32HTXE-S	457	CS-32HTXC-HTMS	499	CS-32HTXO-HTMS
374	CS-32HNXO-TM	416	CCS-32HTXE-HT	458	CS-32HTXC-HTS	500	CS-32HTXO-HTS
375	CS-32HNXO-TMS	417	CCS-32HTXE-HTM	459	CS-32HTXD		
376	CS-32HNXO-TS	418	CCS-32HTXE-HTMS	460	CS-32HTXD-M		
377	CCS-32HTXC	419	CCS-32HTXO	461	CS-32HTXD-MS		
378	CCS-32HTXC-D	420	CCS-32HTXO-D	462	CS-32HTXD-R		