



PART NUMBER	DESCRIPTION
CCR-58S	Commercial Normally Open Multi-throw, DC-26.5GHz
CR-58S	Elite Normally Open Multi-throw, DC-26.5GHz

The CCR-58S/CR-58S is a broadband, multi-throw, electromechanical coaxial switch designed to switch a microwave signal from a common input to any of 3, 4, 5, or 6 outputs. The characteristic impedance is 50 Ohms. The switches are small using the popular connector spacing on a 1.062" dia. circle. Each position has an individual actuator mechanism allowing random position selection. This also gives the minimum switching time.  
With the normally open actuator, all paths are open when the switch is de-energized.



ENVIRONMENTAL AND PHYSICAL CHARACTERISTICS	
Operating Temperature	
Commercial Model, CCR-58S	-40°C to 65°C
Elite Model, CR-58S	-55°C to 85°C
Vibration (MIL-STD-202 Method 214, Condition D, non-operating)	10 g's RMS
Shock (MIL-STD-202 Method 213, Condition D, non-operating)	500 g's
Standard Actuator Life	5,000,000 cycles
Actuator Life w/ Additional Features	1,000,000 cycles
Connector Type	SMA
Humidity (Moisture Seal)	Available
Weight	6 oz. (170.1g) (max.)

ELECTRICAL CHARACTERISTICS	
Form Factor	Multi-Throw, break before make
Frequency Range	
CCR-58S	DC–26.5 GHz
CR-58S	DC–26.5 GHz
Characteristic Impedance	50 Ohms
Operate Time	15 ms (max.)
Release Time	15 ms (max.)
Actuation Voltage Available	12 15 24 28 V
Actuation Current, max. @ ambient	400 205 170 140 mA

PERFORMANCE CHARACTERISTICS							
Frequency	DC–4 GHz	4–8 GHz	8–12 GHz	12–16 GHz	16–20 GHz	20–24 GHz	24–26.5 GHz
Insertion Loss, dB, max.	0.1	0.2	0.2	0.3	0.3	0.4	0.8
Isolation, dB, min.	80	80	80	80	75	70	70
VSWR , max.	1.05:1	1.1:1	1.2:1	1.2:1	1.2:1	1.2:1	1.7:1

### PART NUMBERING SYSTEM

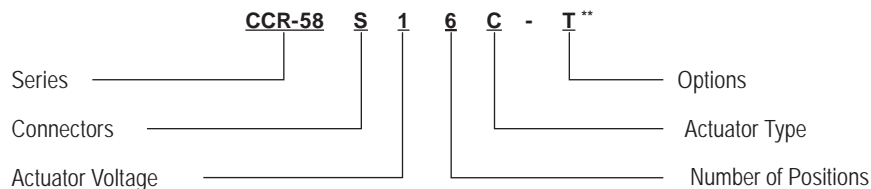

CONNECTOR	ACTUATOR VOLTAGE	NUMBER OF POSITIONS	ACTUATOR TYPE	OPTIONS
S: SMA FEMALE	1: 28 VDC NORMALLY OPEN	3: SP3T	0: NO INDICATOR CONTACTS	T: TTL DRIVERS WITH DIODES
	2: 15 VDC NORMALLY OPEN	4: SP4T	C: INDICATOR CONTACTS	D: COIL TRANSIENT SUPPRESSION DIODES
	3: 12 VDC NORMALLY OPEN	5: SP5T		S: D-SUB CONNECTOR*
	4: 24 VDC NORMALLY OPEN	6: SP6T		TD: DECODERS AND TTL DRIVERS WITH DIODES
				M: MOISTURE SEAL

\*\*SEE PARTS LIST ON PAGE 12-13

**For additional options, please contact factory.**

\* D-Sub Connector may be 9 or 15 pin depending on number of throws. (See Connector Pinout page)

# Series CCR-58S/CR-58S

Multi-Throw DC–26.5 GHz  
Normally Open Coaxial Switch



## SCHEMATICS AND MECHANICAL OUTLINE

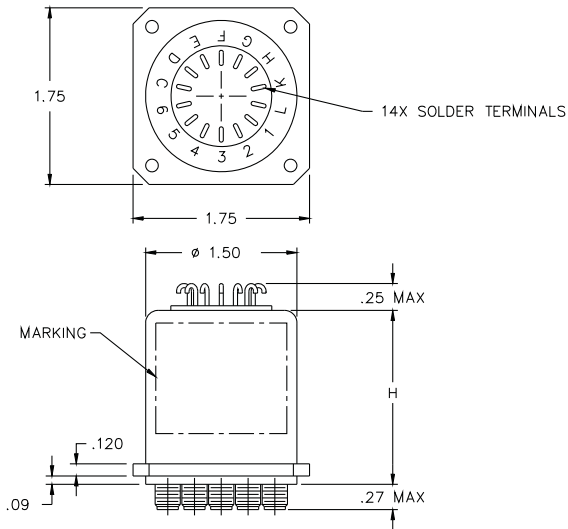
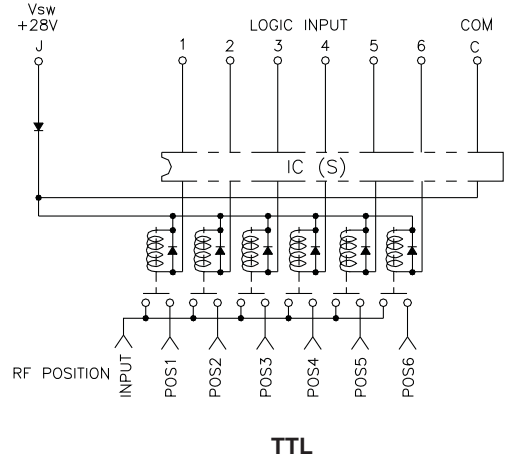
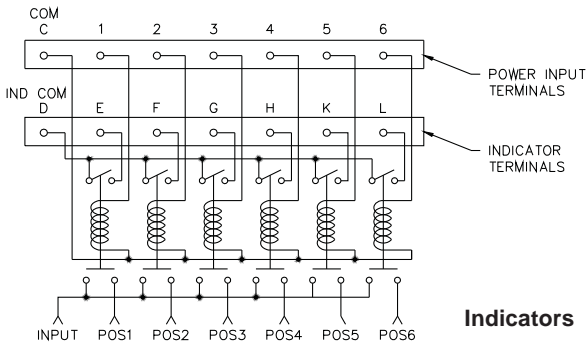
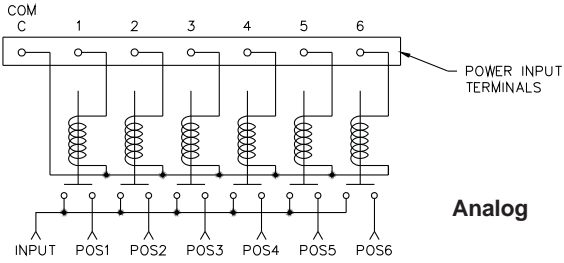

- H = 1.75 STD & Indicator Model
- H = 2.00 D-Sub Model
- H = 2.25 Indicator with D-Sub Model
- H = 2.50 TTL, TTL with Indicators & TTL with D-Sub Model

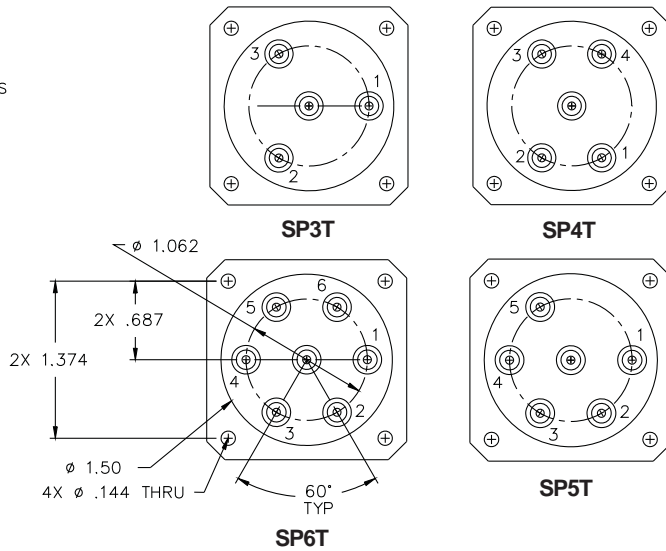

“-S OPTION” 9-PIN D-SUB OR 15-PIN D-MICRO CONNECTOR (EXAMPLE: CCR-58S160-S)

CONNECTOR PINOUT FOR NORMALLY OPEN SP3T MULTI-THROW SWITCHES						
EXAMPLE	CR-58S130-S	CR-58S13C-S	CR-58S130-TS	CR-58S13C-TS	CR-58S130-TDS	CR-58S13C-TDS
INDICATOR		YES		YES		YES
TTL			YES	YES		
DECODERS & TTL					YES	YES
PIN NO.	9-PIN	9-PIN	9-PIN	9-PIN	9-PIN	9-PIN
1	PORT 1	PORT 1	PORT 1	PORT 1	LOGIC 1	LOGIC 1
2	PORT 2	PORT 2	PORT 2	PORT 2	LOGIC 2	LOGIC 2
3	PORT 3	PORT 3	PORT 3	PORT 3		
4		E INDICATOR		E INDICATOR		E INDICATOR
5		F INDICATOR		F INDICATOR		F INDICATOR
6		G INDICATOR		G INDICATOR		G INDICATOR
7	COMMON	COMMON	COMMON	COMMON	COMMON	COMMON
8			VSW	VSW	VSW	VSW
9		D INDICATOR (COM)		D INDICATOR (COM)		D INDICATOR (COM)

CONNECTOR PINOUT FOR NORMALLY OPEN SP4T MULTI-THROW SWITCHES						
EXAMPLE	CR-58S140-S	CR-58S14C-S	CR-58S140-TS	CR-58S14C-TS	CR-58S140-TDS	CR-58S14C-TDS
INDICATOR		YES		YES		YES
TTL			YES	YES		
DECODERS & TTL					YES	YES
PIN NO.	9-PIN	15-PIN	9-PIN	15-PIN	9-PIN	15-PIN
1	PORT 1	PORT 1	TTL 1	TTL 1	LOGIC 1	LOGIC 1
2	PORT 2	PORT 2	TTL 2	TTL 2	LOGIC 2	LOGIC 2
3	PORT 3	PORT 3	TTL 3	TTL 3	LOGIC 3	LOGIC 3
4	PORT 4	PORT 4	TTL 4	TTL 4		
5						
6						
7	COMMON	COMMON	COMMON	COMMON	COMMON	COMMON
8			VSW	VSW	VSW	VSW
9		D INDICATOR (COM)		D INDICATOR (COM)		D INDICATOR (COM)
10	N/A	E INDICATOR	N/A	E INDICATOR	N/A	E INDICATOR
11		F INDICATOR		F INDICATOR		F INDICATOR
12		G INDICATOR		G INDICATOR		G INDICATOR
13		H INDICATOR		H INDICATOR		H INDICATOR
14						
15						

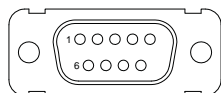

**9-PIN D-SUB CONNECTOR**

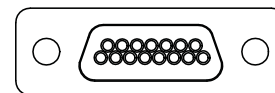

**15-PIN D-MICRO CONNECTOR**

# Series CCR-58S/CR-58S

## Multi-Throw DC–26.5 GHz

### Normally Open Coaxial Switch



CONNECTOR PINOUT FOR NORMALLY OPEN SP5T MULTI-THROW SWITCHES						
EXAMPLE	CR-58S150-S	CR-58S15C-S	CR-58S150-TS	CR-58S15C-TS	CR-58S150-TDS	CR-58S15C-TDS
INDICATOR		Yes		Yes		Yes
TTL			Yes	Yes		
DECODERS & TTL					Yes	Yes
PIN NO.	9-PIN	15-PIN	9-PIN	15-PIN	9-PIN	15-PIN
1	PORT 1	PORT 1	TTL 1	TTL 1	LOGIC 1	LOGIC 1
2	PORT 2	PORT 2	TTL 2	TTL 2	LOGIC 2	LOGIC 2
3	PORT 3	PORT 3	TTL 3	TTL 3	LOGIC 3	LOGIC 3
4	PORT 4	PORT 4	TTL 4	TTL 4		
5	PORT 5	PORT 5	TTL 5	TTL 5		
6						
7	COMMON	COMMON	COMMON	COMMON	COMMON	COMMON
8			VSW	VSW	VSW	VSW
9		D INDICATOR (COM)		D INDICATOR (COM)		D INDICATOR (COM)
10	N/A	E INDICATOR	N/A	E INDICATOR	N/A	E INDICATOR
11		F INDICATOR		F INDICATOR		F INDICATOR
12		G INDICATOR		G INDICATOR		G INDICATOR
13		H INDICATOR		H INDICATOR		H INDICATOR
14		K INDICATOR		K INDICATOR		K INDICATOR
15						

CONNECTOR PINOUT FOR NORMALLY OPEN SP6T MULTI-THROW SWITCHES						
EXAMPLE	CR-58S160-S	CR-58S16C-S	CR-58S160-TS	CR-58S16C-TS	CR-58S160-TDS	CR-58S16C-TDS
INDICATOR		Yes		Yes		Yes
TTL			Yes	Yes		
DECODERS & TTL					Yes	Yes
PIN NO.	9-PIN	15-PIN	9-PIN	15-PIN	9-PIN	15-PIN
1	PORT 1	PORT 1	TTL 1	TTL 1	LOGIC 1	LOGIC 1
2	PORT 2	PORT 2	TTL 2	TTL 2	LOGIC 2	LOGIC 2
3	PORT 3	PORT 3	TTL 3	TTL 3	LOGIC 3	LOGIC 3
4	PORT 4	PORT 4	TTL 4	TTL 4		
5	PORT 5	PORT 5	TTL 5	TTL 5		
6	PORT 6	PORT 6	TTL 6	TTL 6		
7	COMMON	COMMON	COMMON	COMMON	COMMON	COMMON
8			VSW	VSW	VSW	VSW
9		D INDICATOR (COM)		D INDICATOR (COM)		D INDICATOR (COM)
10	N/A	E INDICATOR	N/A	E INDICATOR	N/A	E INDICATOR
11		F INDICATOR		F INDICATOR		F INDICATOR
12		G INDICATOR		G INDICATOR		G INDICATOR
13		H INDICATOR		H INDICATOR		H INDICATOR
14		K INDICATOR		K INDICATOR		K INDICATOR
15		L INDICATOR		L INDICATOR		L INDICATOR

**TRUTH TABLE Normally Open**  
**CCR-58SX3C-T**

Logic Input			RF Path			Indicator Switches		
1	2	3	J1	J2	J3	E	F	G
1	0	0	On	Off	Off	C	0	0
0	1	0	Off	On	Off	0	C	0
0	0	1	Off	Off	On	0	0	C

**TRUTH TABLE Normally Open**  
**CCR-58SX3C-TD**

Logic Input		RF Path			Indicator Switches		
1	2	J1	J2	J3	E	F	G
0	0	On	Off	Off	C	0	0
1	0	Off	On	Off	0	C	0
0	1	Off	Off	On	0	0	C
1	1	Off	Off	Off	0	0	0

**TRUTH TABLE Normally Open**  
**CCR-58SX4C-T**

Logic Input				RF Path				Indicator Switches			
1	2	3	4	J1	J2	J3	J4	E	F	G	H
1	0	0	0	On	Off	Off	Off	C	0	0	0
0	1	0	0	Off	On	Off	Off	0	C	0	0
0	0	1	0	Off	Off	On	Off	0	0	C	0
0	0	0	1	Off	Off	Off	On	0	0	0	C

**TRUTH TABLE Normally Open**  
**CCR-58SX4C-TD**

Logic Input			RF Path				Indicator Switches			
1	2	3	J1	J2	J3	J4	E	F	G	H
0	0	0	On	Off	Off	Off	C	0	0	0
1	0	0	Off	On	Off	Off	0	C	0	0
0	1	0	Off	Off	On	Off	0	0	C	0
1	1	0	Off	Off	Off	On	0	0	0	C
1	1	1	Off	Off	Off	Off	0	0	0	0

# Series CCR-58S/CR-58S

Multi-Throw DC–26.5 GHz

Normally Open Coaxial Switch



**TELEDYNE**  
**COAX SWITCHES**  
Everywhereyoulook™

**TRUTH TABLE Normally Open**  
**CCR-58SX5C-T**

Logic Input					RF Path					Indicator Switches				
1	2	3	4	5	J1	J2	J3	J4	J5	E	F	G	H	K
1	0	0	0	0	On	Off	Off	Off	Off	C	0	0	0	0
0	1	0	0	0	Off	On	Off	Off	Off	0	C	0	0	0
0	0	1	0	0	Off	Off	On	Off	Off	0	0	C	0	0
0	0	0	1	0	Off	Off	Off	On	Off	0	0	0	C	0
0	0	0	0	1	Off	Off	Off	Off	On	0	0	0	0	C

**TRUTH TABLE Normally Open**  
**CCR-58SX5C-TD**

Logic Input			RF Path					Indicator Switches				
1	2	3	J1	J2	J3	J4	J5	E	F	G	H	K
0	0	0	On	Off	Off	Off	Off	C	0	0	0	0
1	0	0	Off	On	Off	Off	Off	0	C	0	0	0
0	1	0	Off	Off	On	Off	Off	0	0	C	0	0
1	1	0	Off	Off	Off	On	Off	0	0	0	C	0
0	0	1	Off	Off	Off	Off	On	0	0	0	0	C
1	1	1	Off	Off	Off	Off	Off	0	0	0	0	0

**TRUTH TABLE Normally Open**  
**CCR-58SX6C-T**

Logic Input						RF Path						Indicator Switches					
1	2	3	4	5	6	J1	J2	J3	J4	J5	J6	E	F	G	H	K	L
1	0	0	0	0	0	On	Off	Off	Off	Off	Off	C	0	0	0	0	0
0	1	0	0	0	0	Off	On	Off	Off	Off	Off	0	C	0	0	0	0
0	0	1	0	0	0	Off	Off	On	Off	Off	Off	0	0	C	0	0	0
0	0	0	1	0	0	Off	Off	Off	On	Off	Off	0	0	0	C	0	0
0	0	0	0	1	0	Off	Off	Off	Off	On	Off	0	0	0	0	C	0
0	0	0	0	0	1	Off	Off	Off	Off	Off	On	0	0	0	0	0	C

**TRUTH TABLE Normally Open**  
**CCR-58SX6C-TD**

Logic Input			RF Path						Indicator Switches					
1	2	3	J1	J2	J3	J4	J5	J6	E	F	G	H	K	L
0	0	0	On	Off	Off	Off	Off	Off	C	0	0	0	0	0
1	0	0	Off	On	Off	Off	Off	Off	0	C	0	0	0	0
0	1	0	Off	Off	On	Off	Off	Off	0	0	C	0	0	0
1	1	0	Off	Off	Off	On	Off	Off	0	0	0	C	0	0
0	0	1	Off	Off	Off	Off	On	Off	0	0	0	0	C	0
1	0	1	Off	Off	Off	Off	Off	On	0	0	0	0	0	C
1	1	1	Off	Off	Off	Off	Off	Off	0	0	0	0	0	0

**TYPICAL NARROWBAND RF INSERTION LOSS PERFORMANCE CURVES**

Insertion Loss (DC-4 GHz)

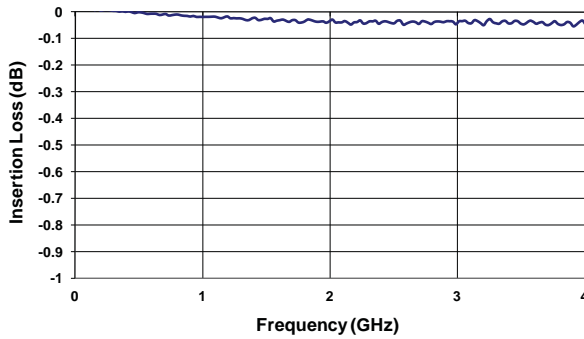

Insertion Loss (4-8 GHz)

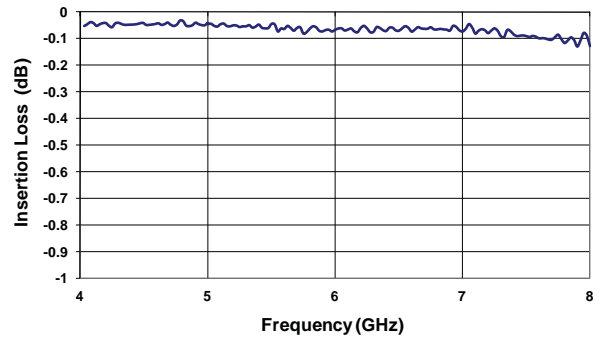

Insertion Loss (8-12 GHz)

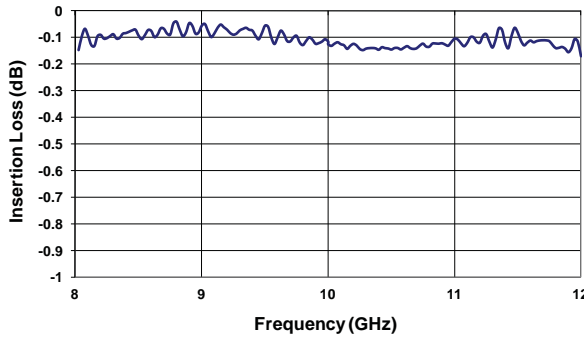

Insertion Loss (12-16 GHz)

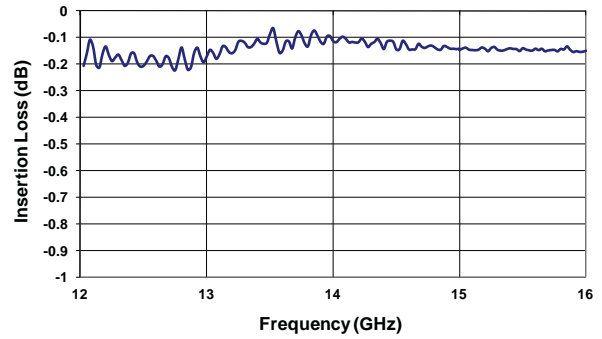

Insertion Loss (16-20 GHz)

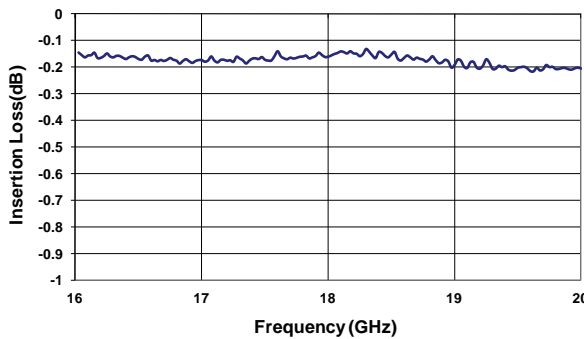

Insertion Loss (20-24 GHz)

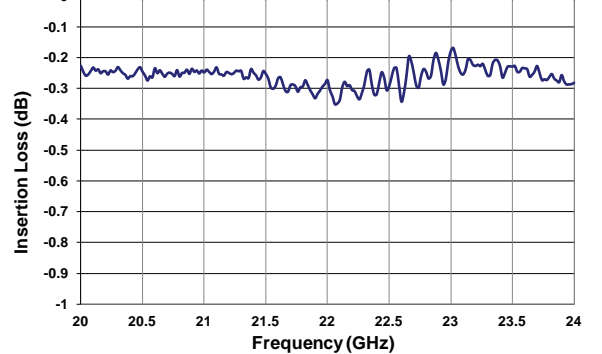

Insertion Loss (24-26.5 GHz)

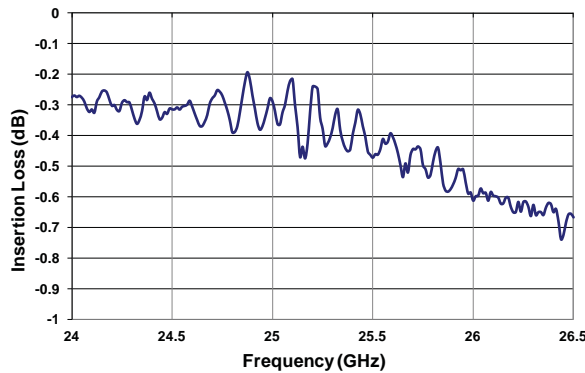

# Series CCR-58S/CR-58S

Multi-Throw DC–26.5 GHz

Normally Open Coaxial Switch



**TELEDYNE**  
**COAX SWITCHES**  
Everywhere you look™

## TYPICAL NARROWBAND RF ISOLATION PERFORMANCE CURVES

Isolation (DC-4 GHz)

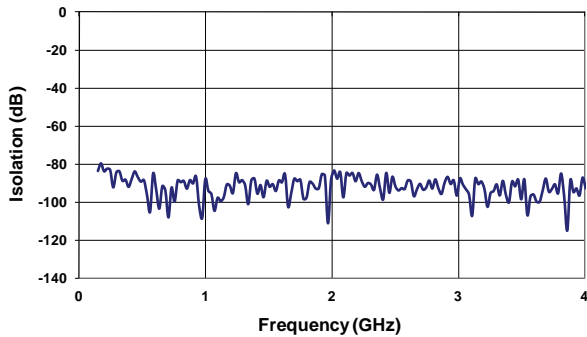

Isolation (4-8 GHz)

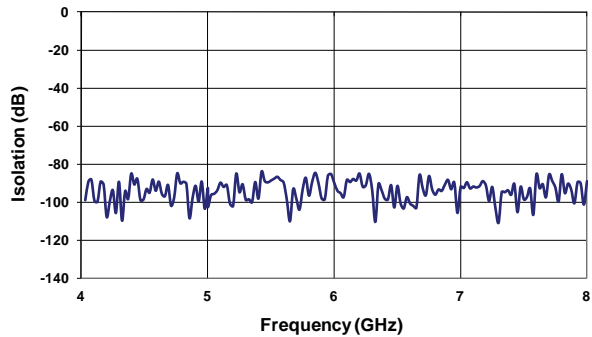

Isolation (8-12 GHz)

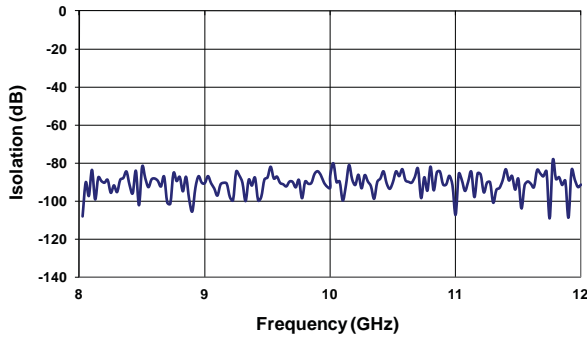

Isolation (12-16 GHz)

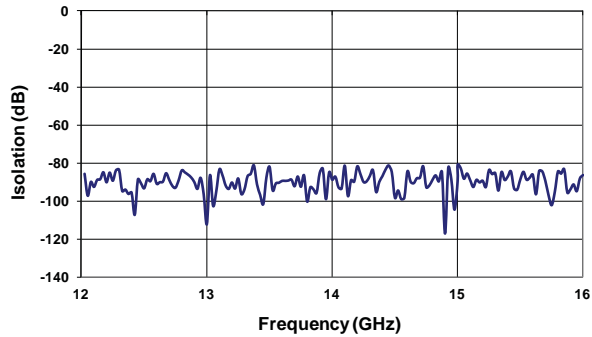

Isolation (16-20 GHz)

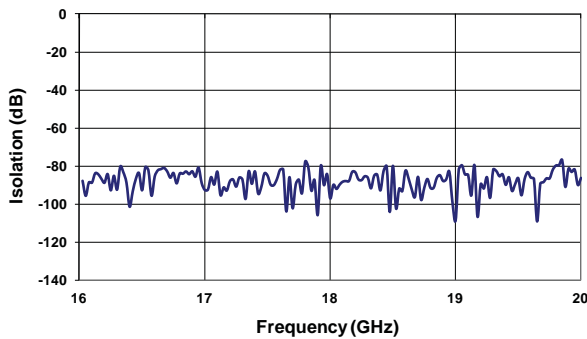

Isolation (20-24 GHz)

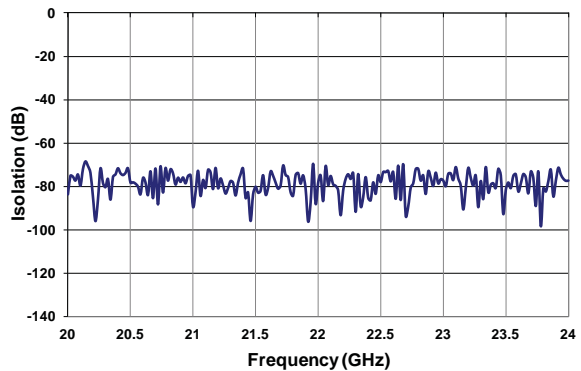

Isolation (24-26.5 GHz)

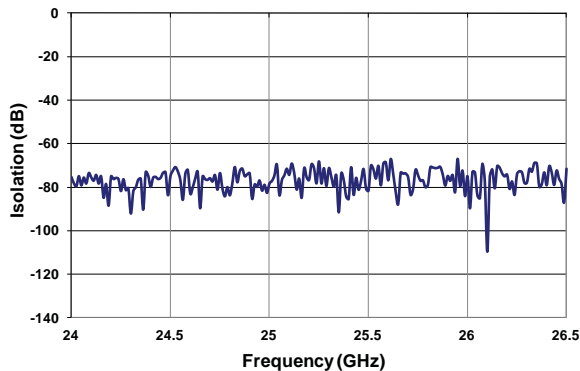



**TYPICAL NARROWBAND RF VSWR PERFORMANCE CURVES**

**VSWR ( DC-4 GHz )**

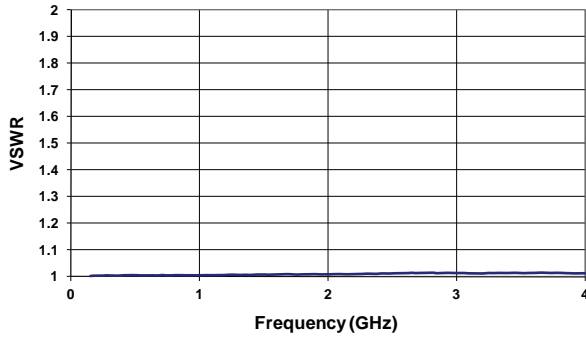

**VSWR ( 4-8 GHz )**

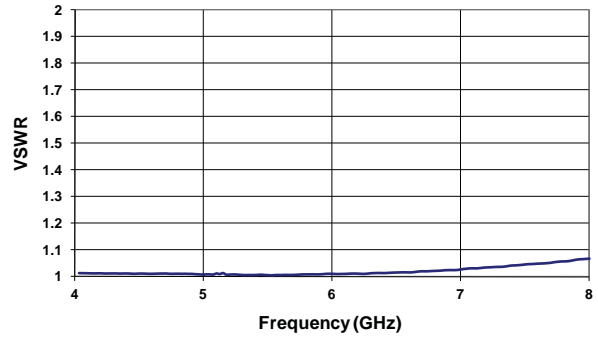

**VSWR ( 8-12 GHz )**

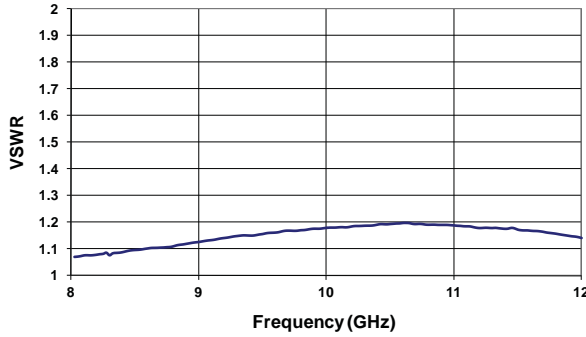

**VSWR ( 12-16 GHz )**

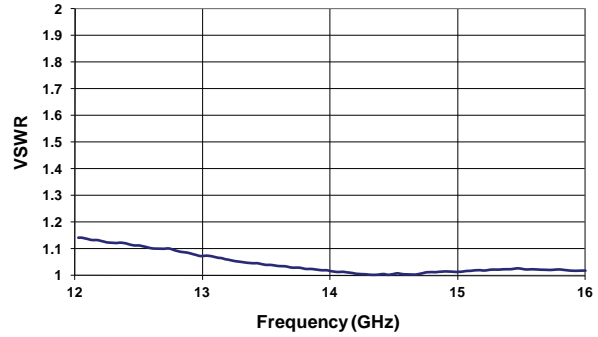

**VSWR ( 16-20 GHz )**

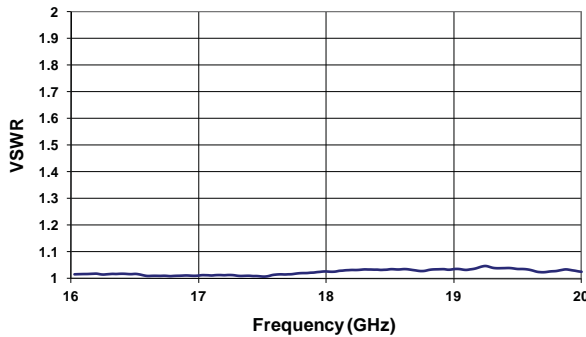

**VSWR ( 20-24 GHz )**

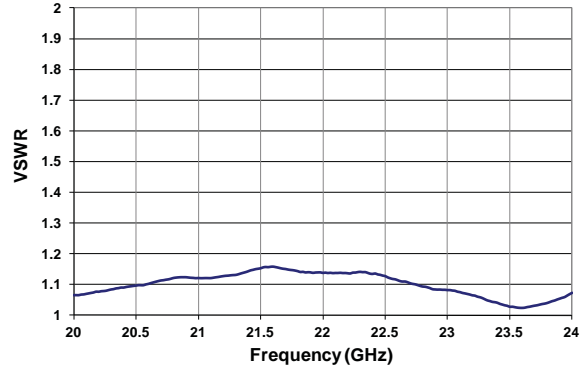

**VSWR ( 24-26.5 GHz )**

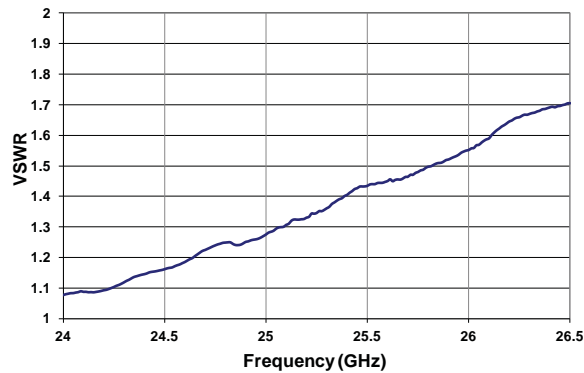

TYPICAL POWER PERFORMANCE CURVE

# Power Handling vs. Frequency

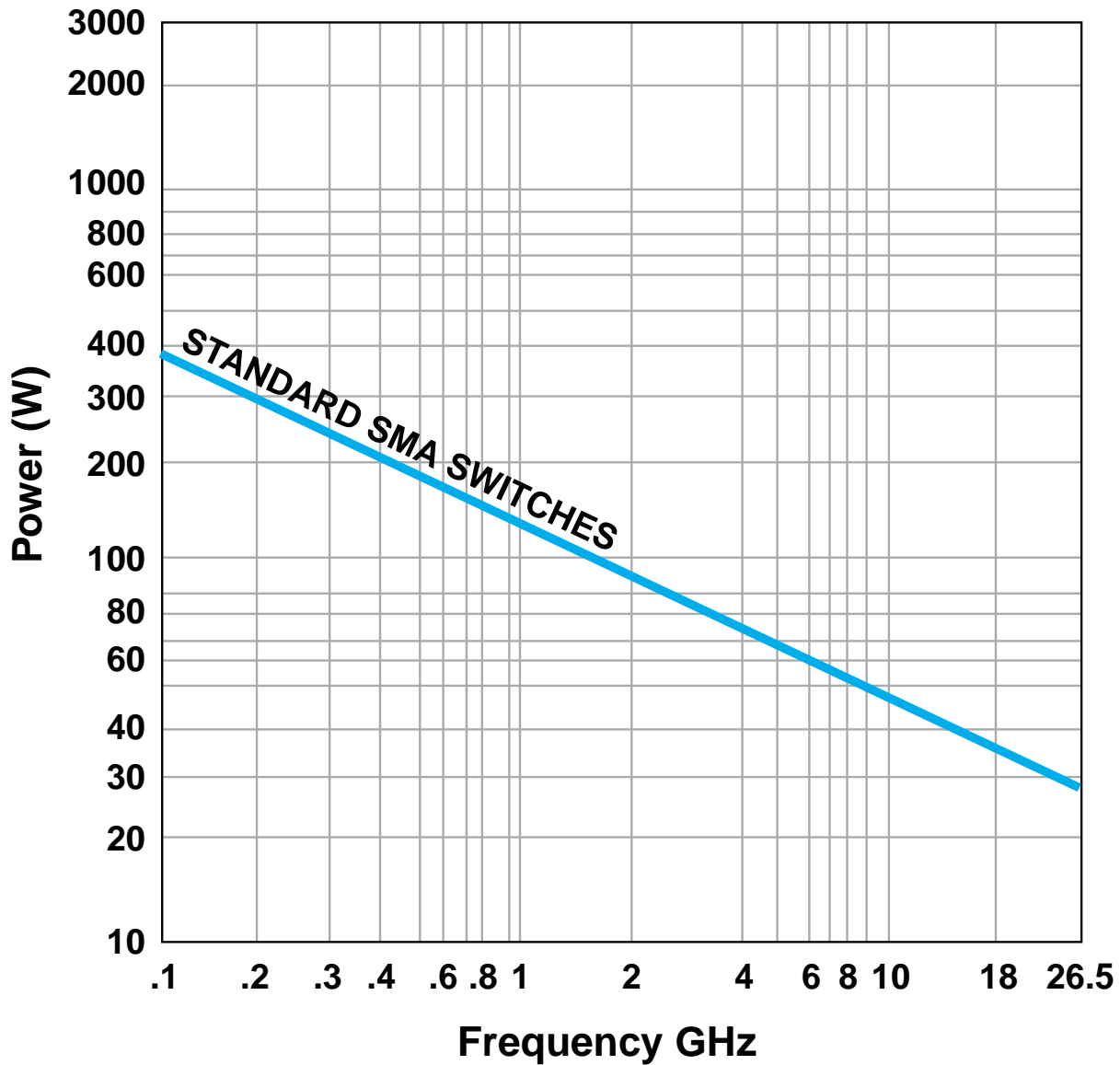

Estimates based on the following reference conditions:

- Ambient temperature of 40°C or less
- Sea level operation
- Load VSWR of 1.20:1 maximum
- No high-power (hot) switching

Please contact Teledyne Coax Switches for derating factors when applications do not meet the foregoing reference conditions.

**GLOSSARY**

**Actuator**

An actuator is the electromechanical mechanism that transfers the RF contacts from one position to another upon DC command.

**Arc Suppression Diode**

A diode is connected in parallel with the coil. This diode limits the “reverse EMF spike” generated when the coil de-energizes to 0.7 volts. The diode cathode is connected to the positive side of the coil and the anode is connected to the negative side.

**Date Code**

All switches are marked with either a unique serial number or a date code. Date codes are in accordance with MIL-STD-1285 Paragraph 5.2.5 and consist of four digits. The first two digits define the year and the last two digits define the week of the year (YYWW). Thus, 1032 identifies switches that passed through final inspection during the 32nd week of 2010.

**Indicator**

Indicators tell the system which position the switch is in. Other names for indicators are telemetry contacts or tellback circuit. Indicators are usually a set of internally mounted DC contacts linked to the actuator. They can be wired to digital input lines, status lights, or interlocks. Unless otherwise specified, the maximum indicator contact rating is 30 Vdc, 50 mA, or 1.5 Watts into a resistive load.

**Isolation**

Isolation is the measure of the power level at the output connector of an unconnected RF channel as referenced to the power at the input connector. It is specified in dB below the input power level.

**Multi-Throw Switch**

A multi-throw switch is a switch with one input and three or more output ports. The CCR-58 can switch a microwave signal to any of 2,3,4,5 or 6 output from a single common input.

**Switching Time**

Switching time is the total interval beginning with the arrival of the leading edge of the command pulse at the switch DC input and ending with the completion of the switch transfer, including contact bounce. It consists of three parts: (1) inductive delay in the coil, (2) transfer time of the physical movement of the contacts, and (3) the bounce time of the RF contacts.

**TTL Switch Driver Option**

As a special option, switch drivers can be provided for both failsafe and latching switches, which are compatible with industry-standard low-power Schottky TTL circuits.

**TD-Option**

This option includes a decoder. The 3-bit parallel command is decoded to internally select the appropriate position. See the logic tables. The TD-Option increases the Vsw supply current demand by 50mA max at 28Vdc and +20°C.

**Performance Parameters vs Frequency**

Generally speaking, the RF performance of coaxial switches is frequency dependent. With increasing frequency, VSWR and insertion loss increase while isolation decreases. All data sheets specify these three parameters as “worst case” at the highest operating frequency. If the switch is to be used over a narrow frequency band, better performance can be achieved.

**Actuator Current vs Temperature**

The resistance of the actuator coil varies as a function of temperature. There is an inverse relationship between the operating temperature of the switch and the actuator drive current. For switches operating at 28 VDC, the approximate actuator drive current at temperature, T, can be calculated using the equation:

$$I_T = \frac{I_A}{[1 + .00385 (T-20)]}$$

Where:

$I_T$  = Actuator current at temperature, T

$I_A$  = Room temperature actuator current – see data sheet

T = Temperature of interest in °C

**Magnetic Sensitivity**

An electro-mechanical switch can be sensitive to ferrous materials and external magnetic fields. Neighboring ferrous materials should be permitted no closer than 0.5 inches and adjacent external magnetic fields should be limited to a flux density of less than 5 Gauss.

**SPECIAL FEATURE**

**Switching High-Power or Highly Sensitive Signals**

Ensure the most linear response with the best galvanically matched contact system in the industry. Extremely low passive intermodulation is standard on all of our switches.

Carrier Frequency 1	Carrier Frequency 2	PIM 3rd Order Frequency	PIM 5th Order Frequency
870 MHz	893 MHz	847 MHz	824 MHz

	3rd Order Intermodulation	5th Order Intermodulation
Multiple Positions	–96 dBm	–115 dBm
	–139 dBc	–158 dBc

# Series CCR-58S/CR-58S

Multi-Throw DC–26.5 GHz  
Normally Open Coaxial Switch



## NORMALLY OPEN CCR-58S/CR-58S PART NUMBER LIST

	PART No.		PART No.		PART No.		PART No.
1	CCR-58SX3C	43	CR-58SX30	85	CR-58SX4C	127	CCR-58SX50
2	CCR-58SX3C-D	44	CR-58SX30-D	86	CR-58SX4C-D	128	CCR-58SX50-D
3	CCR-58SX3C-DM	45	CR-58SX30-DM	87	CR-58SX4C-DM	129	CCR-58SX50-DM
4	CCR-58SX3C-M	46	CR-58SX30-M	88	CR-58SX4C-M	130	CCR-58SX50-M
5	CCR-58SX3C-MS	47	CR-58SX30-MS	89	CR-58SX4C-MS	131	CCR-58SX50-MS
6	CCR-58SX3C-S	48	CR-58SX30-S	90	CR-58SX4C-S	132	CCR-58SX50-S
7	CCR-58SX3C-T	49	CR-58SX30-T	91	CR-58SX4C-T	133	CCR-58SX50-T
8	CCR-58SX3C-TD	50	CR-58SX30-TD	92	CR-58SX4C-TD	134	CCR-58SX50-TD
9	CCR-58SX3C-TDM	51	CR-58SX30-TDM	93	CR-58SX4C-TDM	135	CCR-58SX50-TDM
10	CCR-58SX3C-TDMS	52	CR-58SX30-TDMS	94	CR-58SX4C-TDMS	136	CCR-58SX50-TDMS
11	CCR-58SX3C-TDS	53	CR-58SX30-TDS	95	CR-58SX4C-TDS	137	CCR-58SX50-TDS
12	CCR-58SX3C-TM	54	CR-58SX30-TM	96	CR-58SX4C-TM	158	CCR-58SX50-TM
13	CCR-58SX3C-TMS	55	CR-58SX30-TMS	97	CR-58SX4C-TMS	139	CCR-58SX50-TMS
14	CCR-58SX3C-TS	56	CR-58SX30-TS	98	CR-58SX4C-TS	140	CCR-58SX50-TS
15	CCR-58SX30	57	CCR-58SX4C	99	CR-58SX40	141	CR-58SX5C
16	CCR-58SX30-D	58	CCR-58SX4C-D	100	CR-58SX40-D	142	CR-58SX5C-D
17	CCR-58SX30-DM	59	CCR-58SX4C-DM	101	CR-58SX40-DM	143	CR-58SX5C-DM
18	CCR-58SX30-M	60	CCR-58SX4C-M	102	CR-58SX40-M	144	CR-58SX5C-M
19	CCR-58SX30-MS	61	CCR-58SX4C-MS	103	CR-58SX40-MS	145	CR-58SX5C-MS
20	CCR-58SX30-S	62	CCR-58SX4C-S	104	CR-58SX40-S	146	CR-58SX5C-S
21	CCR-58SX30-T	63	CCR-58SX4C-T	105	CR-58SX40-T	147	CR-58SX5C-T
22	CCR-58SX30-TD	64	CCR-58SX4C-TD	106	CR-58SX40-TD	148	CR-58SX5C-TD
23	CCR-58SX30-TDM	65	CCR-58SX4C-TDM	107	CR-58SX40-TDM	149	CR-58SX5C-TDM
24	CCR-58SX30-TDMS	66	CCR-58SX4C-TDMS	108	CR-58SX40-TDMS	150	CR-58SX5C-TDMS
25	CCR-58SX30-TDS	67	CCR-58SX4C-TDS	109	CR-58SX40-TDS	151	CR-58SX5C-TDS
26	CCR-58SX30-TM	68	CCR-58SX4C-TM	110	CR-58SX40-TM	152	CR-58SX5C-TM
27	CCR-58SX30-TMS	69	CCR-58SX4C-TMS	111	CR-58SX40-TMS	153	CR-58SX5C-TMS
28	CCR-58SX30-TS	70	CCR-58SX4C-TS	112	CR-58SX40-TS	154	CR-58SX5C-TS
29	CR-58SX3C	71	CCR-58SX40	113	CCR-58SX5C	155	CR-58SX50
30	CR-58SX3C-D	72	CCR-58SX40-D	114	CCR-58SX5C-D	156	CR-58SX50-D
31	CR-58SX3C-DM	73	CCR-58SX40-DM	115	CCR-58SX5C-DM	157	CR-58SX50-DM
32	CR-58SX3C-M	74	CCR-58SX40-M	116	CCR-58SX5C-M	158	CR-58SX50-M
33	CR-58SX3C-MS	75	CCR-58SX40-MS	117	CCR-58SX5C-MS	159	CR-58SX50-MS
34	CR-58SX3C-S	76	CCR-58SX40-S	118	CCR-58SX5C-S	160	CR-58SX50-S
35	CR-58SX3C-T	77	CCR-58SX40-T	119	CCR-58SX5C-T	161	CR-58SX50-T
36	CR-58SX3C-TD	78	CCR-58SX40-TD	120	CCR-58SX5C-TD	162	CR-58SX50-TD
37	CR-58SX3C-TDM	79	CCR-58SX40-TDM	121	CCR-58SX5C-TDM	163	CR-58SX50-TDM
58	CR-58SX3C-TDMS	80	CCR-58SX40-TDMS	122	CCR-58SX5C-TDMS	164	CR-58SX50-TDMS
39	CR-58SX3C-TDS	81	CCR-58SX40-TDS	123	CCR-58SX5C-TDS	165	CR-58SX50-TDS
40	CR-58SX3C-TM	82	CCR-58SX40-TM	124	CCR-58SX5C-TM	166	CR-58SX50-TM
41	CR-58SX3C-TMS	83	CCR-58SX40-TMS	125	CCR-58SX5C-TMS	167	CR-58SX50-TMS
42	CR-58SX3C-TS	84	CCR-58SX40-TS	126	CCR-58SX5C-TS	168	CR-58SX50-TS

\* X = 1 (28Vdc), 2 (15Vdc), 3 (12Vdc) and 4 (24Vdc)

**NORMALLY OPEN CCR-58S/CR-58S PART NUMBER LIST**

	<b>PART No.</b>		<b>PART No.</b>
<b>169</b>	CCR-58SX6C	<b>211</b>	CR-58SX60
<b>170</b>	CCR-58SX6C-D	<b>212</b>	CR-58SX60-D
<b>171</b>	CCR-58SX6C-DM	<b>213</b>	CR-58SX60-DM
<b>172</b>	CCR-58SX6C-M	<b>214</b>	CR-58SX60-M
<b>173</b>	CCR-58SX6C-MS	<b>215</b>	CR-58SX60-MS
<b>174</b>	CCR-58SX6C-S	<b>216</b>	CR-58SX60-S
<b>175</b>	CCR-58SX6C-T	<b>217</b>	CR-58SX60-T
<b>176</b>	CCR-58SX6C-TD	<b>218</b>	CR-58SX60-TD
<b>177</b>	CCR-58SX6C-TDM	<b>219</b>	CR-58SX60-TDM
<b>178</b>	CCR-58SX6C-TDMS	<b>220</b>	CR-58SX60-TDMS
<b>179</b>	CCR-58SX6C-TDS	<b>221</b>	CR-58SX60-TDS
<b>180</b>	CCR-58SX6C-TM	<b>222</b>	CR-58SX60-TM
<b>181</b>	CCR-58SX6C-TMS	<b>223</b>	CR-58SX60-TMS
<b>182</b>	CCR-58SX6C-TS	<b>224</b>	CR-58SX60-TS
<b>183</b>	CCR-58SX60		
<b>184</b>	CCR-58SX60-D		
<b>185</b>	CCR-58SX60-DM		
<b>186</b>	CCR-58SX60-M		
<b>187</b>	CCR-58SX60-MS		
<b>188</b>	CCR-58SX60-S		
<b>189</b>	CCR-58SX60-T		
<b>190</b>	CCR-58SX60-TD		
<b>191</b>	CCR-58SX60-TDM		
<b>192</b>	CCR-58SX60-TDMS		
<b>193</b>	CCR-58SX60-TDS		
<b>194</b>	CCR-58SX60-TM		
<b>195</b>	CCR-58SX60-TMS		
<b>196</b>	CCR-58SX60-TS		
<b>197</b>	CR-58SX6C		
<b>198</b>	CR-58SX6C-D		
<b>199</b>	CR-58SX6C-DM		
<b>200</b>	CR-58SX6C-M		
<b>201</b>	CR-58SX6C-MS		
<b>202</b>	CR-58SX6C-S		
<b>203</b>	CR-58SX6C-T		
<b>204</b>	CR-58SX6C-TD		
<b>205</b>	CR-58SX6C-TDM		
<b>206</b>	CR-58SX6C-TDMS		
<b>207</b>	CR-58SX6C-TDS		
<b>208</b>	CR-58SX6C-TM		
<b>209</b>	CR-58SX6C-TMS		
<b>210</b>	CR-58SX6C-TS		

\* X = 1 (28Vdc), 2 (15Vdc), 3 (12Vdc) and 4 (24Vdc)