



PART NUMBER	DESCRIPTION
CCS-37S	Commercial Latching TRANSFER, DC-18GHz
CS-37S	Elite Latching TRANSFER, DC-18GHz



The CCS-37S/CS-37S is a long-life high performance transfer switch designed for use in 50 Ohms coaxial transmission lines operating over frequencies ranging from DC to 18 GHz. The switch is designed for minimum size compatible with SMA connector spacing. This switch is provided with a magnetic latching actuator which is particularly desirable in applications where actuator power consumption must be kept to an absolute minimum. The latching type actuator requires less switching current than the failsafe type. In the self-cutoff version, power is applied only for the very short duration (approximately 50 msec. max.) of the actuator transfer from one position of the other. This makes this type of actuator especially suitable for portable battery operated systems.

ENVIRONMENTAL AND PHYSICAL CHARACTERISTICS	
Operating Temperature	
Commercial Model, CCS-37S	-40°C to 65°C
Elite Model, CS-37S	-55°C to 85°C
Vibration (MIL-STD-202 Method 214, Condition D, non-operating)	10 g's RMS
Shock (MIL-STD-202 Method 213, Condition D, non-operating)	500 g's
Standard Actuator Life	5,000,000 cycles
Actuator Life w/ Additional Features	1,000,000 cycles
Connector Type	SMA
Humidity (Moisture Seal)	Available
Weight	2.5 oz. (70.87g) (max.)

ELECTRICAL CHARACTERISTICS	
Form Factor	TRANSFER, break before make
Frequency Range	
CCS-37S	DC-18 GHz
CS-37S	DC-18 GHz
Characteristic Impedance	50 Ohms
Operate Time	10 ms (max.)
Actuation Voltage Available	12 15 24 28 V
Actuation Current, max. @ ambient	155 125 75 60 mA

PERFORMANCE CHARACTERISTICS					
Frequency	DC-5 GHz	5-10 GHz	10-13 GHz	13-15 GHz	15-18 GHz
Insertion Loss, dB, max.	0.1	0.2	0.4	0.6	0.6
Isolation, dB, min.	90	80	80	80	80
VSWR, max.	1.1:1	1.3:1	1.3:1	1.6:1	1.6:1

PART NUMBERING SYSTEM

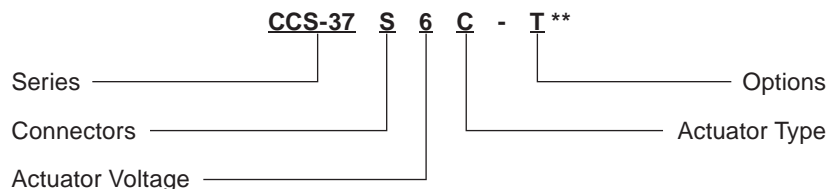

Connector
S: SMA Female

Actuator Voltage
6: 28 Vdc Latching
7: 15 Vdc Latching
8: 12 Vdc Latching
9: 24 Vdc Latching

Actuator Type
0: Standard Contacts
C: Indicator Contacts
D: Self Cutoff Only
E: Indicators and Self Cutoff

Options
T: TTL Drivers with Diodes
D: Transient Suppression Diodes
R: Positive + Common
M: Moisture Seal
S: 9 Pin D-Sub Connector

**SEE PARTS LIST ON PAGE 8

For other options, contact factory.

Series CCS-37S/CS-37S

Miniature DC-18 GHz
Latching TRANSFER Coaxial Switch



SCHEMATICS AND MECHANICAL OUTLINE

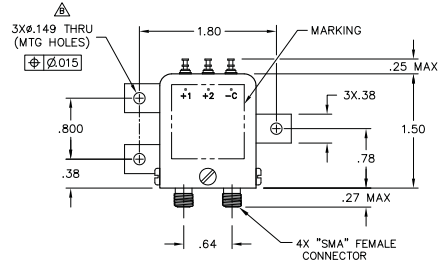
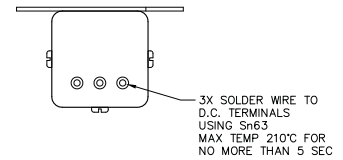
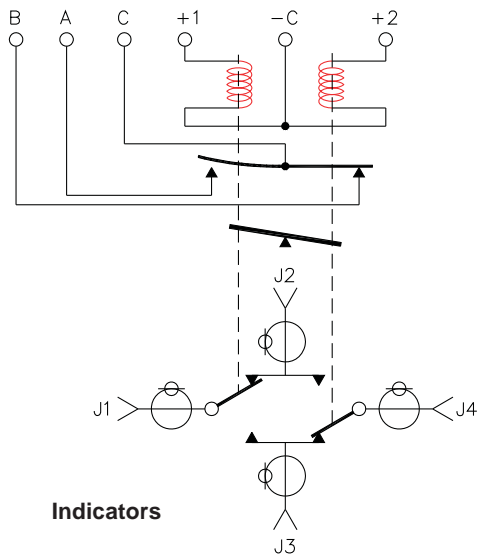
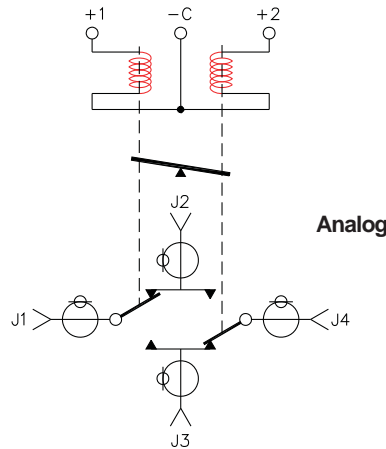
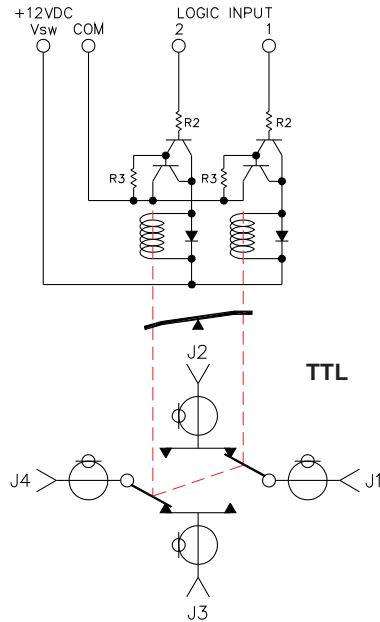

H= 1.50 Max. STD Model
H= 1.75 Max. Indicator & Diode Model
H= 2.00 Max 9-Pin D-Sub & TTL Model

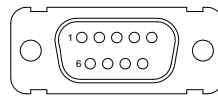
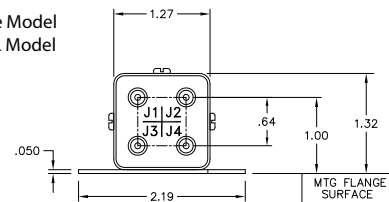

“-S OPTION” 9-PIN D-SUB CONNECTOR (EXAMPLE: CCS-37S60-S)

9 PIN D-SUB PINOUT FOR LATCHING TRANSFER				
Pin No.	OPTIONS			
	Basic	Indicators	TTL	Indicators & TTL
1	1	1		
2	2	2		
3	C	C	Common	Common
4			1	1
5			2	2
6			Vsw	Vsw
7		A		A
8		B		B
9		C		C

TRUTH TABLE (with TTL option)						
Logic Input		RF Path			Indicator (if applicable)	
1	2	1-2	1-3	2-4	3-4	A B
0	0	No Change			N/A	
1	0	Off	On	On	Off	A & C
0	1	On	Off	Off	On	B & C
1	1	Forbidden			N/A	

TYPICAL NARROWBAND RF INSERTION LOSS PERFORMANCE CURVES

Insertion Loss (DC-5 GHz)

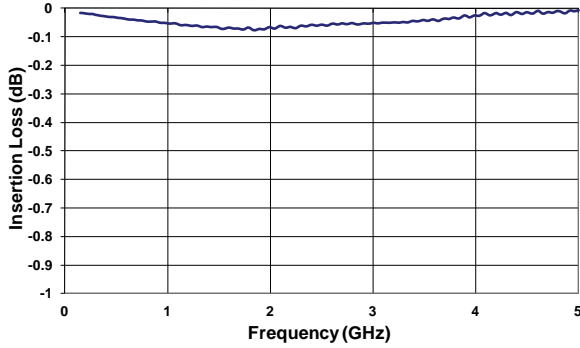

Insertion Loss (5-10 GHz)

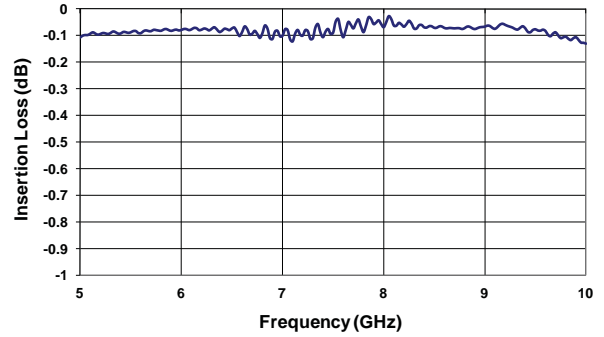

Insertion Loss (10-13 GHz)

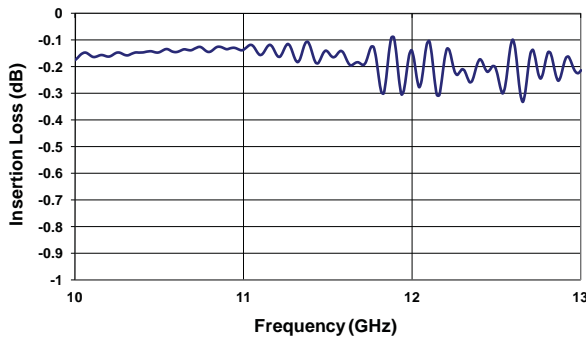

Insertion Loss (13-15 GHz)

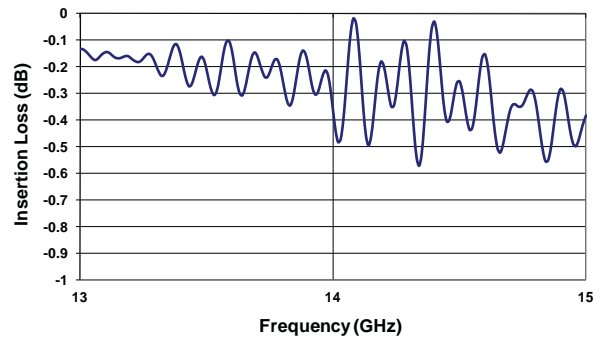

Insertion Loss (15-18 GHz)

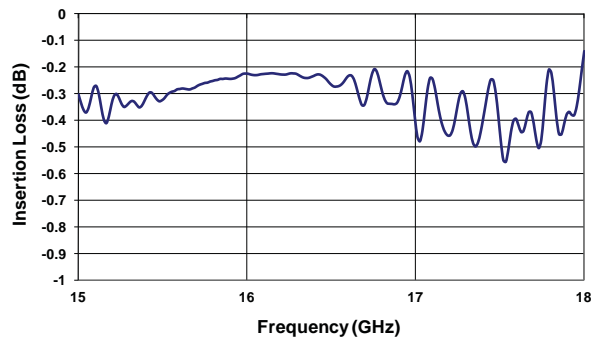

RF NOTES

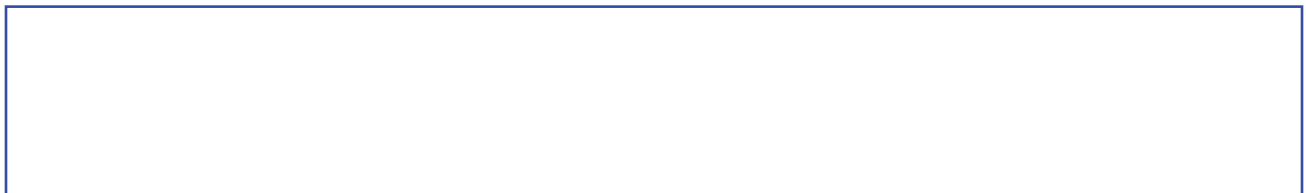

TYPICAL NARROWBAND RF ISOLATION PERFORMANCE CURVES

Isolation (DC-5 GHz)

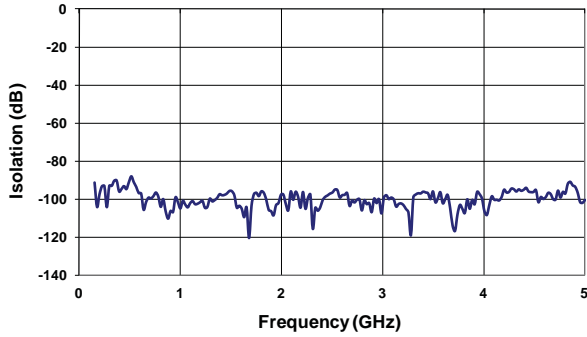

Isolation (5-10 GHz)

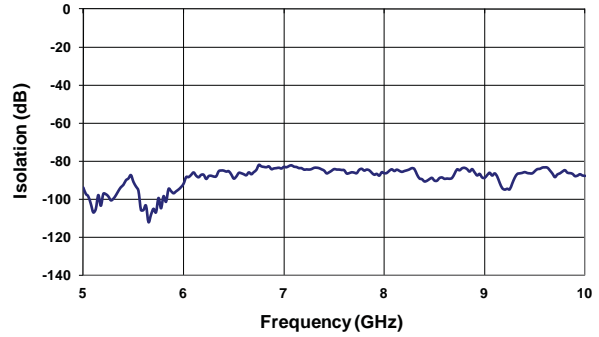

Isolation (10-13 GHz)

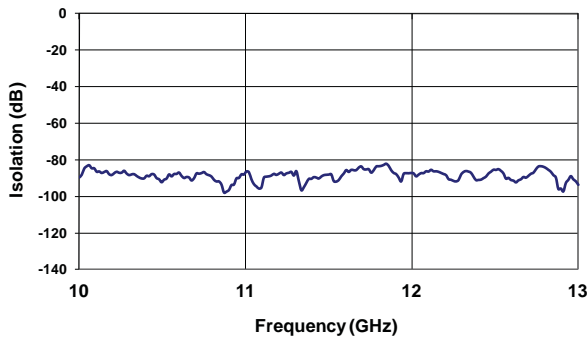

Isolation (13-15 GHz)

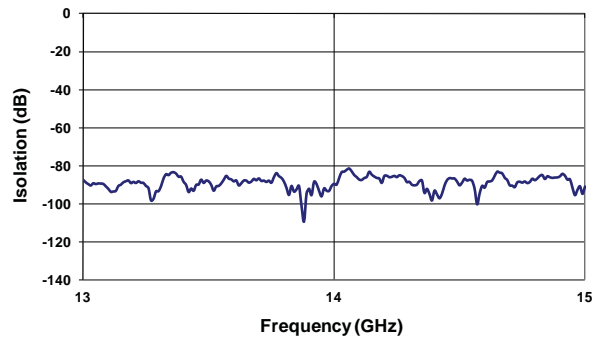

Isolation (15-18 GHz)

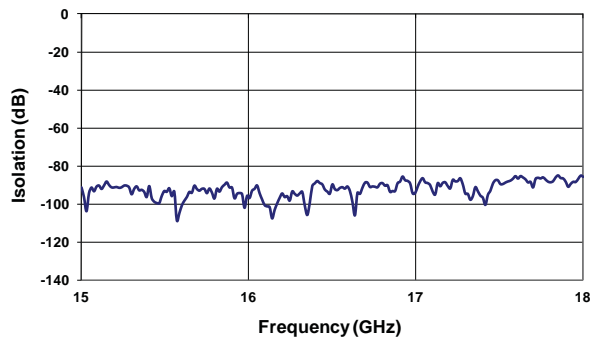

RF NOTES

[Empty box for RF notes]

TYPICAL NARROWBAND RF VSWR PERFORMANCE CURVES

VSWR (DC-5 GHz)

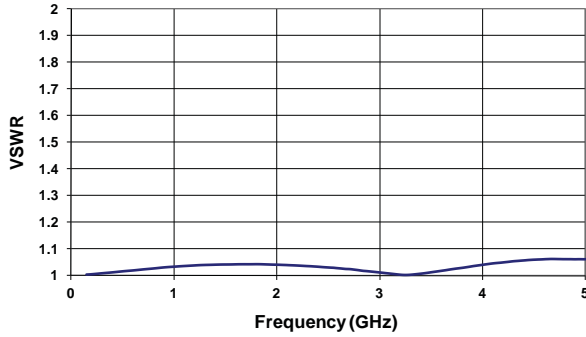

VSWR (5-10 GHz)

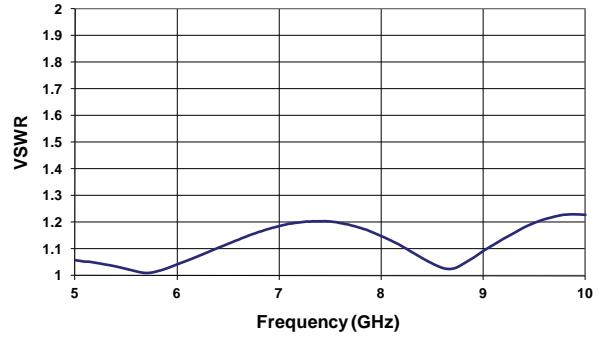

VSWR (10-13 GHz)

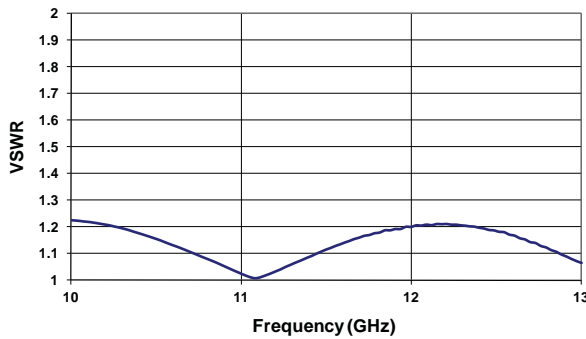

VSWR (13-15 GHz)

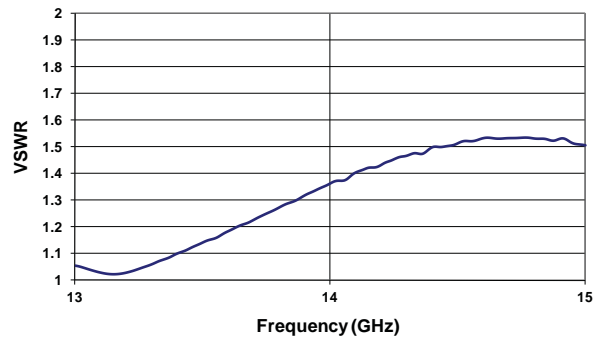

VSWR (15-18 GHz)

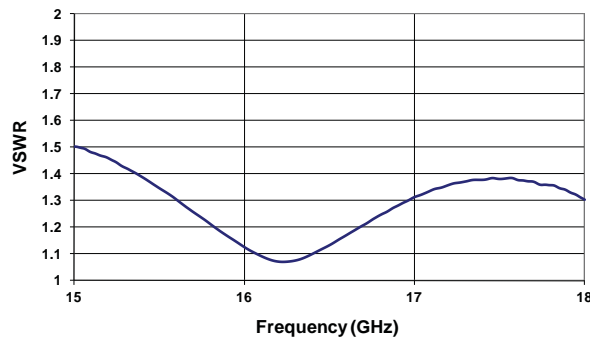

RF NOTES

[Empty box for RF notes]

TYPICAL POWER PERFORMANCE CURVE

Power Handling vs. Frequency

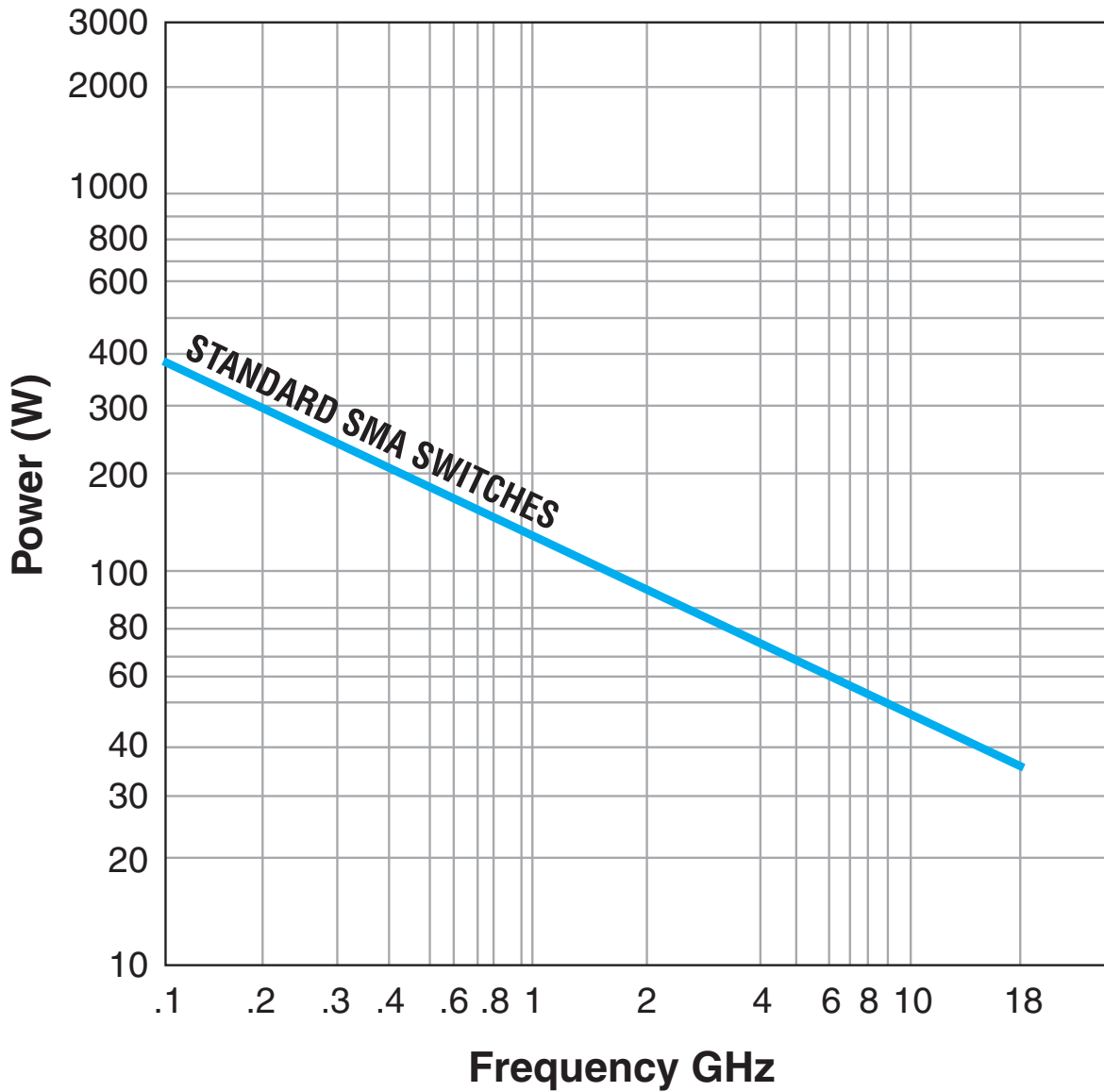

Estimates based on the following reference conditions:

- Ambient temperature of 40°C or less
- Sea level operation
- Load VSWR of 1.20:1 maximum
- No high-power (hot) switching

Please contact Teledyne Coax Switches for derating factors when applications do not meet the foregoing reference conditions.

GLOSSARY

Actuator

An actuator is the electromechanical mechanism that transfers the RF contacts from one position to another upon DC command.

Arc Suppression Diode

A diode is connected in parallel with the coil. This diode limits the “reverse EMF spike” generated when the coil de-energizes to 0.7 volts. The diode cathode is connected to the positive side of the coil and the anode is connected to the negative side.

Date Code

All switches are marked with either a unique serial number or a date code. Date codes are in accordance with MIL-STD-1285 Paragraph 5.2.5 and consist of four digits. The first two digits define the year and the last two digits define the week of the year (YYWW). Thus, 1032 identifies switches that passed through final inspection during the 32nd week of 2010.

Latching

A latching switch remains in the selected position whether or not voltage is maintained. This can be accomplished with either a magnetic or mechanical latching mechanism.

Indicator

Indicators tell the system which position the switch is in. Other names for indicators are telemetry contacts or tellback circuit. Indicators are usually a set of internally mounted DC contacts linked to the actuator. They can be wired to digital input lines, status lights, or interlocks. Unless otherwise specified, the maximum indicator contact rating is 30 Vdc, 50 mA, or 1.5 Watts into a resistive load.

Isolation

Isolation is the measure of the power level at the output connector of an unconnected RF channel as referenced to the power at the input connector. It is specified in dB below the input power level.

Self-Cutoff

The self-cutoff option disables the actuator current on completion of actuation. Either a series contact (linked to the actuator) or an IC driver circuit provides the current cutoff. This option results in minimum power consumption by the RF switch. Cutthroat is another name used in the industry for this option. Pulse latching is a term used to describe a switch without this feature.

TRANSFER Switch

A four-port switch consisting of two independent pairs of RF paths. These pairs are actuated simultaneously. This actuation is similar to that of a double-pole double-throw switch.

Switching Time

Switching time is the total interval beginning with the arrival of the leading edge of the command pulse at the switch DC

input and ending with the completion of the switch transfer, including contact bounce. It consists of three parts: (1) inductive delay in the coil, (2) transfer time of the physical movement of the contacts, and (3) the bounce time of the RF contacts.

TTL Switch Driver Option

As a special option, switch drivers can be provided for both failsafe and latching switches, which are compatible with industry-standard low-power Schottky TTL circuits.

Performance Parameters vs Frequency

Generally speaking, the RF performance of coaxial switches is frequency dependent. With increasing frequency, VSWR and insertion loss increase while isolation decreases. All data sheets specify these three parameters as “worst case” at the highest operating frequency. If the switch is to be used over a narrow frequency band, better performance can be achieved.

Actuator Current vs Temperature

The resistance of the actuator coil varies as a function of temperature. There is an inverse relationship between the operating temperature of the switch and the actuator drive current. For switches operating at 28 VDC, the approximate actuator drive current at temperature, T, can be calculated using the equation:

$$I_T = \frac{I_A}{[1 + .00385 (T-20)]}$$

Where:

I_T = Actuator current at temperature, T

I_A = Room temperature actuator current – see data sheet

T = Temperature of interest in °C

Magnetic Sensitivity

An electro-mechanical switch can be sensitive to ferrous materials and external magnetic fields. Neighboring ferrous materials should be permitted no closer than 0.5 inches and adjacent external magnetic fields should be limited to a flux density of less than 5 Gauss.

SPECIAL FEATURE

Switching High-Power or Highly Sensitive Signals

Ensure the most linear response with the best galvanically matched contact system in the industry. Extremely low passive intermodulation is standard on all of our switches.

Carrier Frequency 1	Carrier Frequency 2	PIM 3rd Order Frequency	PIM 5th Order Frequency
870 MHz	893 MHz	847 MHz	824 MHz

	3rd Order Intermodulation	5th Order Intermodulation
Transfer	-103 dBm	-123 dBm
	-146 dBc	-165 dBc

Series CCS-37S/CS-37S

Miniature DC-18 GHz

Latching TRANSFER Coaxial Switch



TELEDYNE
COAX SWITCHES
Everywhereyoulook™

LATCHING CCS-37S/CS-37S PART NUMBER LIST

	PART No.		PART No.		PART No.
1	CCS-37SXC	43	CCS-37SX0	85	CS-37SXD-MS
2	CCS-37SXC-D	44	CCS-37SX0-D	86	CS-37SXD-R
3	CCS-37SXC-DM	45	CCS-37SX0-DM	87	CS-37SXD-RM
4	CCS-37SXC-DMS	46	CCS-37SX0-DMS	88	CS-37SXD-RMS
5	CCS-37SXC-DR	47	CCS-37SX0-DR	89	CS-37SXD-RS
6	CCS-37SXC-DRM	48	CCS-37SX0-DRM	90	CS-37SXD-S
7	CCS-37SXC-DRMS	49	CCS-37SX0-DRMS	91	CS-37SXD-T
8	CCS-37SXC-DRS	50	CCS-37SX0-DRS	92	CS-37SXD-TM
9	CCS-37SXC-DS	51	CCS-37SX0-DS	93	CS-37SXD-TMS
10	CCS-37SXC-M	52	CCS-37SX0-M	94	CS-37SXE
11	CCS-37SXC-MS	53	CCS-37SX0-MS	95	CS-37SXE-M
12	CCS-37SXC-R	54	CCS-37SX0-R	96	CS-37SXE-MS
13	CCS-37SXC-RM	55	CCS-37SX0-RM	97	CS-37SXE-R
14	CCS-37SXC-RMS	56	CCS-37SX0-RMS	98	CS-37SXE-RM
15	CCS-37SXC-RS	57	CCS-37SX0-RS	99	CS-37SXE-RMS
16	CCS-37SXC-S	58	CCS-37SX0-S	100	CS-37SXE-RS
17	CCS-37SXC-T	59	CCS-37SX0-T	101	CS-37SXE-S
18	CCS-37SXC-TM	60	CCS-37SX0-TM	102	CS-37SXE-T
19	CCS-37SXC-TMS	61	CCS-37SX0-TMS	103	CS-37SXE-TM
20	CCS-37SXC-TS	62	CCS-37SX0-TS	104	CS-37SXE-TMS
21	CCS-37SXD	63	CS-37SXC	105	CS-37SX0
22	CCS-37SXD-M	64	CS-37SXC-D	106	CS-37SX0-D
23	CCS-37SXD-MS	65	CS-37SXC-DM	107	CS-37SX0-DM
24	CCS-37SXD-R	66	CS-37SXC-DMS	108	CS-37SX0-DMS
25	CCS-37SXD-RM	67	CS-37SXC-DR	109	CS-37SX0-DR
26	CCS-37SXD-RMS	68	CS-37SXC-DRM	110	CS-37SX0-DRM
27	CCS-37SXD-RS	69	CS-37SXC-DRMS	111	CS-37SX0-DRMS
28	CCS-37SXD-S	70	CS-37SXC-DRS	112	CS-37SX0-DRS
29	CCS-37SXD-T	71	CS-37SXC-DS	113	CS-37SX0-DS
30	CCS-37SXD-TM	72	CS-37SXC-M	114	CS-37SX0-M
31	CCS-37SXD-TMS	73	CS-37SXC-MS	115	CS-37SX0-MS
32	CCS-37SXE	74	CS-37SXC-R	116	CS-37SX0-R
33	CCS-37SXE-M	75	CS-37SXC-RM	117	CS-37SX0-RM
34	CCS-37SXE-MS	76	CS-37SXC-RMS	118	CS-37SX0-RMS
35	CCS-37SXE-R	77	CS-37SXC-RS	119	CS-37SX0-RS
36	CCS-37SXE-RM	78	CS-37SXC-S	120	CS-37SX0-S
37	CCS-37SXE-RMS	79	CS-37SXC-T	121	CS-37SX0-T
38	CCS-37SXE-RS	80	CS-37SXC-TM	122	CS-37SX0-TM
39	CCS-37SXE-S	81	CS-37SXC-TMS	123	CS-37SX0-TMS
40	CCS-37SXE-T	82	CS-37SXC-TS	124	CS-37SX0-TS
41	CCS-37SXE-TM	83	CS-37SXD		
42	CCS-37SXE-TMS	84	CS-37SXD-M		

* X = 6 (28Vdc), 7 (15Vdc), 8 (12Vdc) and 9 (24Vdc)