

# Military Solid-State Relays Selection Guide

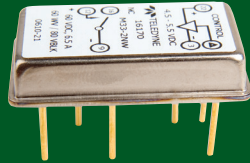

Silicon Carbide

Bidirectional

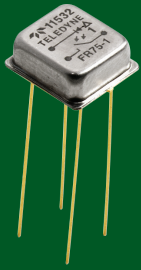
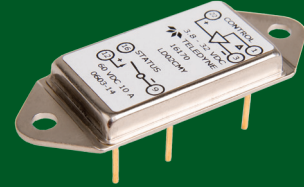
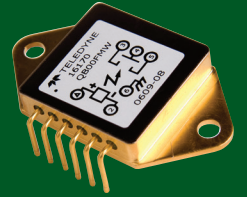

High Voltage

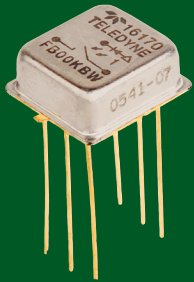

Short-Circuit Protection

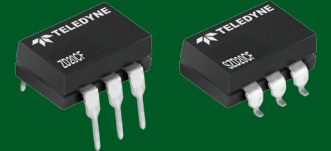

Current Limiting

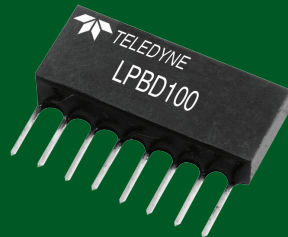

AC or DC

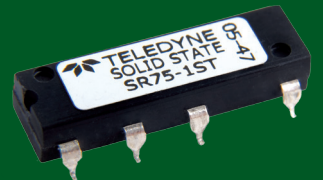

Optical Isolation

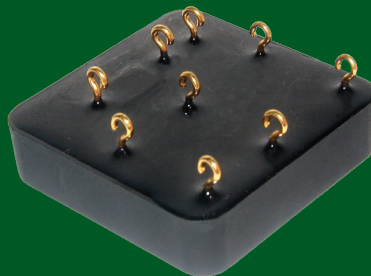

Low Leakage

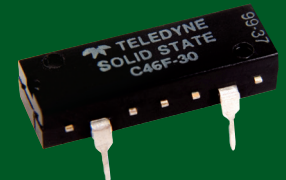

**TELEDYNE  
RELAYS**  
Everywhere you look™

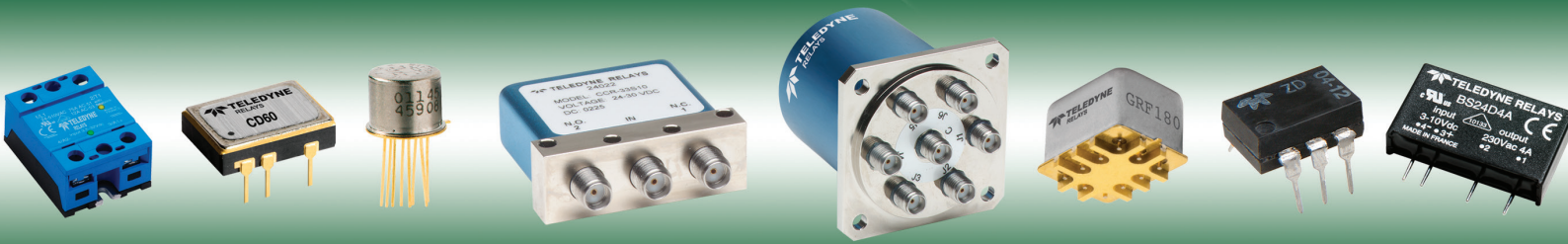

# Switching Solutions

Teledyne Relays has been the world's innovative leader in manufacturing ultraminiature, hermetically sealed, electromechanical and solid-state switching products for more than 50 years. The company's comprehensive product line meets a wide range of requirements for defense and aerospace, industrial, commercial, medical and RF & wireless uses.

## Business Focus

- MIL QPL & COTS Solid-State Relays
- MIL QPL & COTS Electromechanical Relays
- HiRel (Space) Electromechanical Relays
- RF & Microwave Relays & Coaxial Switches
- Industrial Solid-State Relays
- Switching Matrices

## Markets

- Commercial & Military Aviation
- Defense & Aerospace
- Telecom/Communications (Wireless)
- Instrumentation & Test
- Industrial Power & Motion Control
- Medical Applications

## Product Assurance

Under an aggressive Total Quality Management (TQM) program, Teledyne Relays has embraced a "continuous improvement" culture. With recognized certifications such as Boeing D6-82479, MIL-STD-790, AS9100C and ISO 9001:2008, Teledyne Relays has become a primary supplier of switching solutions with the highest quality and reliability to industry leaders around the world.

## Technical Service & Customer Support

Teledyne Relays provides easy access to technical service and customer support. Our websites make it easy to find technical information, buy products and even get e-mail responses within 24 hours. Switching solutions are only a mouse click away at [www.teledynereleys.com](http://www.teledynereleys.com) or at [teledyne-europe.com](http://teledyne-europe.com). Information about coax switches is available at [www.teledynecoax.com](http://www.teledynecoax.com).

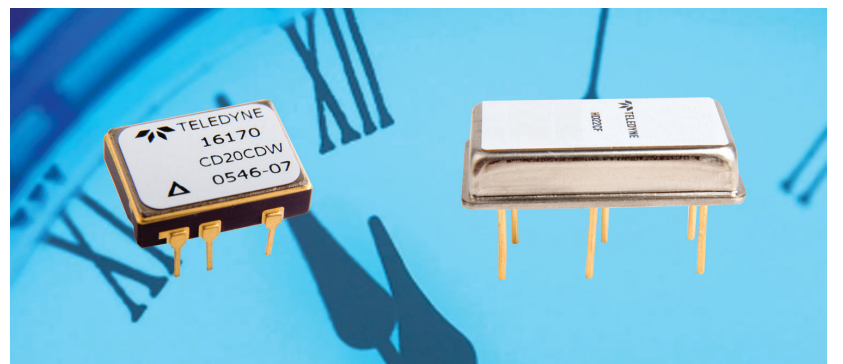

**20 Years of Life-Cycle Testing** — Series CD and HD solid-state relays have undergone 105,000 hours of permanent testing without a single failure. That's the equivalent of 480 million cycles. Test conditions featured a full load at 50% duty cycle, 85°C ambient temperature and V-load = 60 Vdc. The test parts met all given specifications.

# Table of Contents

AC/DC/BI*	Output		Input	Package	Product / Series	Page
	Current	Voltage				
DC	20 A	270 Vdc	4.2 - 18 Vdc	Low Profile	LD00KQ	1
	10 A	270 Vdc	4.2 - 32 Vdc	Low Profile	LD00KM	1
	1 A	60 Vdc	8 - 20 mAdc	6-pin DIP	C63	1
	0.25 A	60 Vdc	3.8 - 5.5 Vdc	Mini-Dip Metal	FR75	1
	2 A	60 Vdc	3.8 - Vdc	6-pin DIP	CD	2
	2.1 A	60 Vdc	3.8 - 32 Vdc	Low Profile	HD	2
	5 A	60 Vdc	0.3 - 3.8 Vdc	Low Profile	KD / LD	3
	2 A	60 Vdc	3.8 - 32 Vdc	Low Profile	KD44CF	3
	0.25 A	100 Vdc	4 - 7 Vdc	Compact SIP	LPBD100	3
	0.25 A	28 Vdc	4 - 7 Vdc	Compact SIP	LPD60a	4
	0.25 A	33 Vdc	4 - Vdc	Compact SIP	LPD70	4
	7 A	60 Vdc	4.5 - 5.5 Vdc	Low Profile	M33-2N	4
	1.5 A	60 Vdc	3.8 - 32 Vdc	16-pin DIP	SR75-1	4
	0.5 A	400 Vdc	3.8-32 Vdc	16-pin DIP	SR75-2	4
	1 A	60 Vdc	8 - 20 mAdc	6-pin DIP	ZD20CD	5
	2 A	60 Vdc	8 - 20 mAdc	6-pin DIP	ZD20CF	5
	0.5 A	80 Vdc	8 - 20 mAdc	6-pin DIP	ZD24CC	5
	0.4 - 1.75 A	50 - 360 Vdc	3.8-32 Vdc	14-pin DIP	C47	5
	1 A	60 Vdc	4.5 - 5.5 Vdc	16-pin DIP	C75	5
AC	1.1 A	20 - 250 Vac	24 - 32 Vdc	Low Profile	2305115-2T	6
	2 - 25 A	250 Vrms	3.8 - 32 Vdc	COTS	652	6
	2 A	250 Vrms	3.8 - 32 Vdc	Low Profile	682	6
	2 A	250 Vrms	3.8 - 32 Vdc	Low Profile	KA	7
	2 A	250 Vrms	3.8 - 32 Vdc	Low Profile	LA	7
BI	0.5 - 2 A	80 - 350 Vdc	10 - 25 mAdc	6-pin DIP	FB	7
	7.5 A	150 Vdc	4.5 - 16 Vdc	Low Profile	QB	7
	0.5 - 2.5 A	60 - 400 Vdc	10 - 50 mAdc	6-pin DIP	C60	8
Appendix: Quality Conformance Inspection						9
Appendix: Glossary						10
		<h3>InP1012</h3> <ul style="list-style-type: none"> <li>• Greater than 40Gbps bandwidth</li> <li>• Frequency range, DC to 60GHz</li> <li>• Small form factor, 3mm X 3mm X 1mm</li> <li>• High isolation</li> <li>• Low insertion loss</li> <li>• Switching time of less than 100ns</li> </ul> <p>See Page 11</p>				
		<h3>RF121 / GRF121</h3> <ul style="list-style-type: none"> <li>• Broader bandwidth (DC - 18GHz)</li> <li>• Signal integrity up to 40Gbps</li> <li>• SPDT, Magnetic Latching</li> <li>• Metal Enclosure for EMI shielding</li> <li>• High Repeatability</li> <li>• 3 Million Cycle Life</li> </ul> <p>See Page 12</p>				
Miniature Matrix Box						13
Teledyne Custom Hybrid Solutions						14
Other Products Overview						15-20

## SILICON CARBIDE DC RELAYS



### Series LD Optically Isolated, Silicon Carbide DC Solid-State Relay

Series LD solid-state relays utilize MIL-PRF-28750 test methods and are packaged in low-profile hermetically sealed cases. These relays are constructed with state-of-the-art solid state techniques and feature fully floating power FET output technology. This allows the load to be connected to either output terminal and provides a low ON resistance. The input and output are optically isolated.

- High Voltage
- Optical isolation
- Meets 270 Vdc requirements of MIL-STD-704
- Low-profile hermetic package
- Meets MIL-PRF-28750 requirements

<b>Isolation Type</b>
Optically Isolated
<b>Operating Temperature</b>
-55°C to +125°C
<b>Mounting</b>
Through-hole
<b>Dimensions LxWxH</b>
2.105 x 0.81 x 0.296 in. 53.47 x 20.574 x 7.518 mm

Part No.	OUTPUT (Load)			INPUT (Control)
	Load Voltage	Load Current	ON Resistance	Input Voltage
LD00KQ*	270 Vdc	20 A	.025 Ω	4.2–18 Vdc
LD00KM*	270 Vdc	10 A	0.042 Ω	4.2–32 Vdc

\*A "W" suffix denoting Teledyne's S<sup>2</sup>R reliability screening level or "Y" suffix denoting MIL-PRF-28750 level must be added to the part number. See Appendix, page 14.

## DC RELAYS

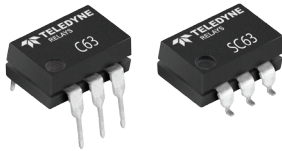

### Series C63 Optically Isolated DC Solid-State Relays

Series C63 solid-state relays use an advanced design capable of switching heavy loads in a physically small 6-pin mini-DIP package. These relays have a power FET output that ensures low ON resistance and low leakage current. Optical isolation ensures complete protection of signal lines, power and ground bus and control circuits from switching noise and EMI.

- Low ON-state resistance
- Up to 1A output
- Optically isolated
- Floating output
- Through-hole or surface-mount configuration

Part No.	OUTPUT (Load)				INPUT (Control)	MECHANICAL		
	Load Voltage	Load Current	ON Resistance	Isolation Type	Input Current	Operating Temperature	Mounting	Dimensions LxWxH
C63-10	60 Vdc	1 Adc	0.55 Ω	Optically Isolated	8–20 mA	-40°C to +85°C	Through-hole	0.39 x 0.25 x 0.15 in. 9.91 x 6.35 x 3.81 mm
SC63-10	60 Vdc	1 Adc	0.55 Ω	Optically Isolated	8–20 mA	-40°C to +85°C	Surface	0.39 x 0.25 x 0.175 in. 9.91 x 6.35 x 4.45 mm

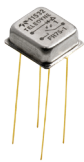

### Series FR75-1 Optically Isolated, Short-Circuit Protected DC Solid-State Relays

The FR75-1 solid-state relay utilizes a power FET switch that is protected against short circuits and overload currents. The short-circuit protection feature provides protection when a short or overload occurs while the relay is on as well as when the relay is switched into a short. The FR75-1 is packaged in a low-profile mini-DIP metal package.

- Optical isolation
- Low OFF-state leakage
- Switches high currents
- High noise immunity
- High dielectric strength

Part No.	OUTPUT (Load)				INPUT (Control)	MECHANICAL		
	Load Voltage	Load Current	ON Resistance	Isolation Type	Input Voltage	Operating Temperature	Mounting	Dimensions LxWxH
FR75-1	60 Vdc	1 Adc	0.32 Ω	Optically Isolated	3.8–5.5 Vdc	-40°C to +85°C	Through-hole	0.423 x 0.463 x 0.19 in. 10.74 x 11.76 x 4.83 mm



**Series CD Optically Isolated, Short-Circuit Protected DC Solid-State Relays**

The CD solid-state relay utilizes the latest FET technology to provide a low ON resistance. The control circuit is buffered to enable the relay to be driven directly from standard CMOS or open-collector TTL logic circuits. Available options include short-circuit, current overload protection, and control status. Both options are available either together or separately as standard features.

- Fast switching speed
- Optical isolation
- Meets 28 Vdc requirements of MIL-STD-704
- Low-profile hermetic ceramic package
- Meets MIL-PRF-28750 requirements

Isolation Type
Optically Isolated
Operating Temperature
-55°C to +105°C
Mounting
CD = Through-hole SCD = Surface
Dimensions LxWxH
0.560 x 0.395 x 0.155 in. 41.22 x 10.03 x 3.94 mm

Part No.	OUTPUT (Load)			INPUT (Control)		OPTIONS	
	Load Voltage	Load Current	ON Resistance	Bias Supply Voltage	CMOS Control	Short-Circuit Protection	Control Status
CD00CF*	60 Vdc	2 Adc	0.22 Ω	3.8–6 Vdc	250 μA		
SCD00CF*	60 Vdc	2 Adc	0.22 Ω	3.8–6 Vdc	250 μA		
CD01CF*	60 Vdc	2 Adc	0.22 Ω	3.8–6 Vdc	250 μA		✓
SCD01CF*	60 Vdc	2 Adc	0.22 Ω	3.8–6 Vdc	250 μA		✓
CD20CD*	60 Vdc	1 Adc	0.45 Ω	3.8–6 Vdc	250 μA	✓	
SCD20CD*	60 Vdc	1 Adc	0.45 Ω	3.8–6 Vdc	250 μA	✓	
CD21CD*	60 Vdc	1 Adc	0.45 Ω	3.8–6 Vdc	250 μA	✓	✓
SCD21CD*	60 Vdc	1 Adc	0.45 Ω	3.8–6 Vdc	250 μA	✓	✓

\*A "W" suffix denoting Teledyne's S<sup>2</sup>R reliability screening level or "Y" suffix denoting MIL-PRF-28750 level must be added to the part number. See Appendix, page 14.



**Series HD True-Output Status-Feedback DC Solid-State Relays**

The HD solid-state relay utilizes the latest technology to provide a low ON resistance and an optically isolated output. The control circuit is buffered to enable the relay to be driven directly from standard CMOS or open-collector TTL logic circuits. Available options include short-circuit and current overload protection. The second option is a status output line.

- Fast switching speed
- Optical isolation
- Meets 28 Vdc requirements of MIL-STD-704
- Low-profile hermetic ceramic package
- Meets MIL-PRF-28750 requirements

Part No.	OUTPUT (Load)				INPUT (Control)		MECHANICAL			OPTIONS	
	Load Voltage	Load Current	ON Resistance	Isolation Type	Bias Supply Voltage	CMOS Control	Operating Temperature	Mounting	Dimensions LxWxH	Short-Circuit Protection	Switch Status
HD00CF*	60 Vdc	2.1 Adc	0.15 Ω	Optically Isolated	3.8–32 Vdc	250 μA	-55°C to +105°C	Through-hole	0.890 x .530 x 0.190 in. 22.6 x 13.5 x 4.83 mm		
HD02CF*	60 Vdc	2.1 Adc	0.15 Ω	Optically Isolated	3.8–32 Vdc	250 μA	-55°C to +105°C	Through-hole	0.890 x .530 x 0.190 in. 22.6 x 13.5 x 4.83 mm		✓
HD20CF*	60 Vdc	2.1 Adc	0.15 Ω	Optically Isolated	3.8–32 Vdc	250 μA	-55°C to +105°C	Through-hole	0.890 x .530 x 0.190 in. 22.6 x 13.5 x 4.83 mm	✓	
HD22CF*	60 Vdc	2.1 Adc	0.15 Ω	Optically Isolated	3.8–32 Vdc	250 μA	-55°C to +105°C	Through-hole	0.890 x .530 x 0.190 in. 22.6 x 13.5 x 4.83 mm	✓	✓
HD24CF*	60 Vdc	2.1 Adc	0.15 Ω	Optically Isolated	3.8–32 Vdc	250 μA	-55°C to +105°C	Through-hole	0.890 x .530 x 0.190 in. 22.6 x 13.5 x 4.83 mm	✓	Trip Status

\*A "W" suffix denoting Teledyne's S<sup>2</sup>R reliability screening level or "Y" suffix denoting MIL-PRF-28750 level must be added to the part number. See Appendix, page 14.

## DC RELAYS

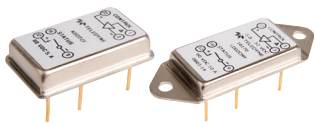

### Series KD/LD Optically Isolated, Short-Circuit Protected DC Solid-State Relays

Series KD and LD solid-state relays utilize MIL-PRF-28750 test methods and are packaged in low-profile hermetically sealed cases. They feature fully floating power FET output technology. Options include short-circuit and current overload protection plus a status output line. Switch status returns the true status of the output switch and is optically isolated from the load.

- Fast switching speed
- Optical isolation
- Meets 28 Vdc requirements of MIL-STD-704
- Low-profile hermetic package
- Meets MIL-PRF-28750 requirements

Isolation Type
Optically Isolated
Operating Temperature
-55°C to +105°C
Mounting
Through-hole
Dimensions LxWxH
KD: 1.375 x 0.801 x 0.22 in. 34.92 x 20.34 x 5.59 mm
LD: 2.105 x 0.801 x 0.22 in. 53.47 x 20.34 x 5.59 mm

Part No.	OUTPUT (Load)			INPUT (Control)		OPTIONS	
	Load Voltage	Load Current	ON Resistance	Input Current	Input Voltage	Short-Circuit Protection	Switch Status
KD00CK*	60 Vdc	5 Adc	0.075 Ω	15 mAdc (TTL) 1 mAdc (CMOS)	3.8 Vdc (TTL) 0.3 Vdc (CMOS)		
KD02CK*	60 Vdc	5 Adc	0.075 Ω	15 mAdc (TTL) 1 mAdc (CMOS)	3.8 Vdc (TTL) 0.3 Vdc (CMOS)		✓
KD20CK*	60 Vdc	5 Adc	0.100 Ω	15 mAdc (TTL) 1 mAdc (CMOS)	3.8 Vdc (TTL) 0.3 Vdc (CMOS)	✓	
KD22CK*	60 Vdc	5 Adc	0.100 Ω	15 mAdc (TTL) 1 mAdc (CMOS)	3.8 Vdc (TTL) 0.3 Vdc (CMOS)	✓	✓
LD00CM*	60 Vdc	5 Adc (10 Adc with heat sink)	0.075 Ω	15 mAdc (TTL) 1 mAdc (CMOS)	3.8 Vdc (TTL) 0.3 Vdc (CMOS)		
LD02CM*	60 Vdc	5 Adc (10 Adc with heat sink)	0.075 Ω	15 mAdc (TTL) 1 mAdc (CMOS)	3.8 Vdc (TTL) 0.3 Vdc (CMOS)		✓
LD20CM*	60 Vdc	5 Adc (10 Adc with heat sink)	0.100 Ω	15 mAdc (TTL) 1 mAdc (CMOS)	3.8 Vdc (TTL) 0.3 Vdc (CMOS)	✓	
LD22CM*	60 Vdc	5 Adc (10 Adc with heat sink)	0.100 Ω	15 mAdc (TTL) 1 mAdc (CMOS)	3.8 Vdc (TTL) 0.3 Vdc (CMOS)	✓	✓

\*A "W" suffix denoting Teledyne's S<sup>2</sup>R reliability screening level or "Y" suffix denoting MIL-PRF-28750 level must be added to the part number. See Appendix, page 14.

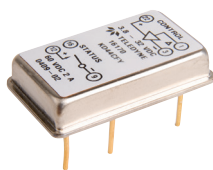

### Series KD44CF DC Solid-State Relays with Flat Trip Short-Circuit Protection

The KD44CF solid-state relay utilizes MIL-PRF-28750 test methods. These relays feature fully floating power FET outputs that allow the load to be connected to either output terminal and provides a low ON resistance. A trip status indicator turns on when an overcurrent condition has occurred and the short-circuit protection has been activated.

- Short-circuit and overload protected
- Trip status
- Meets 28 Vdc requirements of MIL-STD-704
- Low-profile hermetic ceramic package
- Meets MIL-PRF-28750 requirements

Part No.	OUTPUT (Load)				INPUT (Control)		MECHANICAL		
	Load Voltage	Load Current	ON Resistance	Isolation Type	Bias Supply Voltage	CMOS Control	Operating Temperature	Mounting	Dimensions LxWxH
KD44CF*	60 Vdc	2 Adc	0.30 Ω	Optically Isolated	3.8-32 Vdc	250 μAdc	-55°C to +105°C	Through-hole	1.375 x 0.801 x 0.295 in. 34.92 x 20.34 x 7.49 mm

\*A "W" or "Y" suffix denoting Teledyne's S<sup>2</sup>R reliability screening level or MIL-PRF-28750 level must be added to the part number. See Appendix, page 14.

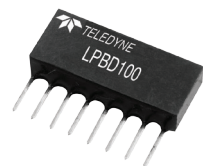

### Series LPBD100 Normally Closed Dual-Output DC Solid-State Relays

The LPBD100 is a dual-output 100 Vdc plastic relay. The relay output-switch contacts are normally closed and will conduct the load current until a voltage is applied to the relay input. With 4 volts or more at the relay input, the output-switch contacts open and the relay no longer conducts. The LPBD100 assembly contains two independent, completely isolated relays.

- Compact SIP plastic package
- Dual output: two relays in one package
- Optical isolation
- Two MOSFETs for reliable operation
- Low voltage drop

Part No.	OUTPUT (Load)				INPUT (Control)	MECHANICAL		
	Load Voltage	Load Current	ON Resistance	Isolation Type	Input Voltage	Operating Temperature	Mounting	Dimensions LxWxH
LPBD100	100 Vdc	0.25 A	5 Ω	Optically Isolated	4-7 Vdc	-40°C to +85°C	Through-hole	0.79 x 0.37 x 0.14 in. 20.07 x 9.39 x 3.55 mm



### Series LPD Normally Open Dual-Output DC Solid-State Relays

Series LPD dual-output plastic relays offer internal thermal protection. They utilize optical isolation for excellent input-to-output isolation. The LPD offers a current-limiting output to protect itself and associated load circuits from transient current overloads. During an overcurrent condition, the LPD clamps the current to a safe operating value.

- Current limiting output
- Thermal protection
- Automatic recovery
- Overload protection
- Low voltage drop

Part No.	OUTPUT (Load)				INPUT (Control)		MECHANICAL		
	Load Voltage	Load Current	ON Resistance	Isolation Type	Input Voltage	Operating Temperature	Mounting	Dimensions LxWxH	
LPD60a	28 Vdc	0.25 A	2 Ω	Optically Isolated	4–7 Vdc	–40°C to +85°C	Through-hole	0.79 x 0.37 x 0.14 in. 20.07 x 9.39 x 3.55 mm	
LPD70	33 Vdc	0.25 A	2 Ω	Optically Isolated	4–7 Vdc	–40°C to +85°C	Through-hole	0.79 x 0.37 x 0.14 in. 20.07 x 9.39 x 3.55 mm	

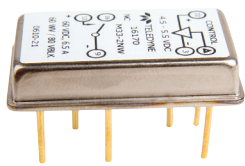

### Series M33-2N Transformer Isolated, High-Surge-Current DC Solid-State Relays

The M33-2N is a military-style DC solid-state relay designed for high-current pulse load applications. It features the latest power FET output technology to minimize ON resistance. This feature provides minimum output voltage drop and allows the M33-2N to switch high pulse currents up to 100 amps at higher temperatures than those allowable with bipolar devices.

- Fast switching speed
- Optical isolation
- Transformer isolated
- Low-profile, hermetic, 22-pin metal DIP
- Meets MIL-PRF-28750 requirements

Part No.	OUTPUT (Load)				INPUT (Control)		MECHANICAL		
	Load Voltage	Load Current	ON Resistance	Isolation Type	Bias Supply Voltage	CMOS Control	Operating Temperature	Mounting	Dimensions LxWxH
M33-2N*	60 Vdc	7 A @25°C	0.09 Ω	Transformer	4.5–5.5 Vdc	80 μA	–55°C to +125°C	Through-hole	1.376 x .801 x .290 in. 34.95 x 20.35 x 7.36 mm

\*A "W" suffix denoting Teledyne's S<sup>2</sup>R reliability screening level or "Y" suffix denoting MIL-PRF-28750 level must be added to the part number. See Appendix, page 14.

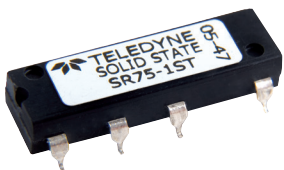

### Series SR75 Optically Isolated, Short-Circuit Protected DC Solid-State Relays

The SR75 solid-state relay utilizes a power FET switch that is protected against overload and short-circuit currents. The short-circuit protection feature not only provides protection should a short or overload occur while the relay is on, but will provide protection should the relay be switched into a short. It comes in through-hole or surface-mount 16-pin DIP packages.

- For AC application using a bridge rectifier
- Low OFF-state leakage
- Switches high voltages and currents
- High noise immunity
- High dielectric strength

Isolation Type
Optically Isolated
Operating Temperature
–55°C to +105°C
Mounting
Basic Relay = Through-hole S Suffix = Surface
Dimensions LxWxH
0.855 x 0.25 x 0.16 in. 27.71 x 6.35 x 4.06 mm

Part No.	OUTPUT (Load)			INPUT (Control)
	Load Voltage	Load Current	ON Resistance	Input Voltage
SR75-1*	60 Vdc	1.5 Adc	0.5 Ω	3.8–32Vdc
SR75-1S*	60 Vdc	1.5 Adc	0.5 Ω	3.8–32Vdc
SR75-2*	300 Vdc	0.75 Adc	2 Ω	3.8–32Vdc
SR75-2S*	300 Vdc	0.75 Adc	2 Ω	3.8–32Vdc

\*A "W" or "T" suffix denoting Teledyne's S<sup>2</sup>R reliability screening level must be added to the part number. See Appendix, page 14.

## DC RELAYS

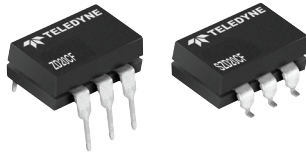

### ZD Optically Isolated, Short-Circuit Protected DC Solid-State Relays

Series ZD solid-state relays use an advanced design capable of switching heavy loads in a physically small 6-pin DIP package. These relays have a power FET output that ensures low ON resistance and low leakage current. Optical isolation ensures complete protection of signal lines, power and ground bus and control circuits from switching noise and EMI.

- Short-circuit protected
- Overload protected
- Low OFF-state leakage
- Trip status on ZD24 series
- Compact 6-pin DIP package

Isolation Type
Optically Isolated
Operating Temperature
-55°C to +105°C
Mounting
ZD = Through-hole SZD = Surface
Dimensions LxWxH
0.39 x 0.25 x 0.15 in. 9.91 x 6.35 x 3.81 mm

Part No.	OUTPUT (Load)			INPUT (Control)
	Load Voltage	Load Current	ON Resistance	Input Current
ZD20CD*	80 Vdc	1 Adc	0.55 Ω	8–20 mA
SZD20CD*	80 Vdc	1 Adc	0.55 Ω	8–20 mA
ZD20CF*	60 Vdc	2 Adc	0.15 Ω	8–20 mA
SZD20CF*	60 Vdc	2 Adc	0.15 Ω	8–20 mA
ZD24CC*	80 Vdc	500 mA	1 Ω	8–20 mA
SZD24CC*	80 Vdc	500 mA	1 Ω	8–20 mA

\*A "W" or "T" suffix denoting Teledyne's S<sup>2</sup>R reliability screening level must be added to the part number. See Appendix, page 14.



### Series C47F Optically Isolated DC Solid-State Relays

The Series C47F miniature solid-state relays utilize a photovoltaic generator driving high-performance power FET chips to provide low-output on resistance and high-output switching capability. The virtual elimination of offset voltage makes these relays ideal for low-level switching applications as well. Bidirectional switching versions (Series C46F) are available.

- 14-pin DIP package
- Switches high voltages and currents
- Optical isolation
- Floating output
- High noise immunity

Part No.	OUTPUT (Load)				INPUT (Control)	MECHANICAL		
	Load Voltage	Load Current	ON Resistance	Isolation Type	Input Voltage	Operating Temperature	Mounting	Dimensions LxWxH
C47F-10	50 Vdc	1.75 Adc	0.15 Ω	Optically Isolated	3.8–32 Vdc	-40°C to +100°C	Through-hole	0.75 x .25 x .165 in. 19.05 x 6.35 x 4.19 mm
C47F-20	90 Vdc	1 Adc	0.35 Ω	Optically Isolated	3.8–32 Vdc	-40°C to +100°C	Through-hole	0.75 x .25 x .165 in. 19.05 x 6.35 x 4.19 mm
C47F-30	180 Vdc	0.6 Adc	1 Ω	Optically Isolated	3.8–32 Vdc	-40°C to +100°C	Through-hole	0.75 x .25 x .165 in. 19.05 x 6.35 x 4.19 mm
C47F-40	360 Vdc	0.4 Adc	2 Ω	Optically Isolated	3.8–32 Vdc	-40°C to +100°C	Through-hole	0.75 x .25 x .165 in. 19.05 x 6.35 x 4.19 mm

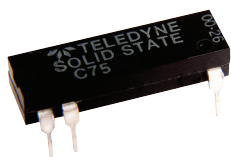

### Series C75 DC Solid-State Relays with Short-Circuit Protection and Trip Status

Series C75-2 solid-state relays are packaged in a 16-pin DIP, with surface-mount or through-hole mounting available. They utilize a power FET switch that is protected against overload and short-circuit currents. 2S versions provide an open-collector trip status feedback to the relay's control side. 2SH versions add an internal transient voltage suppressor for inductive loads.

- Optically isolated
- Low OFF-state leakage
- Switches currents to 1 Adc
- High dielectric strength
- Through-hole or surface-mount configuration

Isolation Type
Optically Isolated
Operating Temperature
-40°C to +85°C
Mounting
C = Through-hole SC = Surface
Dimensions LxWxH
0.85 x 0.250 x 0.165 in. 21.59 x 6.35 x 4.19 mm

Part No.	OUTPUT (Load)			INPUT (Control)	OPTIONS		
	Load Voltage	Load Current	ON Resistance	Input Voltage	Short-Circuit Protection	Trip Status	Transient Voltage Protection
C75-2	60 Vdc	1 Adc	0.9 Ω	4.5–5.5 Vdc	✓		
SC75-2	60 Vdc	1 Adc	0.9 Ω	4.5–5.5 Vdc	✓		
C75-2S	60 Vdc	1 Adc	0.9 Ω	4.5–5.5 Vdc	✓	✓	
SC75-2S	60 Vdc	1 Adc	0.9 Ω	4.5–5.5 Vdc	✓	✓	
C75-2SH	60 Vdc	1 Adc	0.9 Ω	4.5–5.5 Vdc	✓	✓	✓
SC75-2SH	60 Vdc	1 Adc	0.9 Ω	4.5–5.5 Vdc	✓	✓	✓





**Series 2305115-2T 3-Phase AC Solid-State Relays**

The 2305115-2T relay is a 3-phase solid-state relay with status indication. Relay inputs and outputs are optically isolated. The 2305115-2T relay is designed for 3-phase, 47–440 Hz applications where low EMI and reliable operation under conditions of severe environmental stress are a requirement.

- No heat sink required
- ESD class 2 compliance per MIL-STD-833, method 3015
- Compliant with MIL-STD-704D
- Status verification of the input command

Part No.	OUTPUT (Load)				INPUT (Control)	MECHANICAL		
	Load Voltage	Load Current	ON-State Voltage Drop	Isolation Type	Input Voltage	Operating Temperature	Mounting	Dimensions LxWxH
2305115-2T	20–250 Vac	1.1 Arms	1.5 Vrms	Optically Isolated	24–32 Vdc	–40°C to +85°C	Epoxy	1.585 x 1.585 x 0.750 in. 40.26 x 40.26 x 19.05 mm

Model with flange mount available (above). Flange is for mounting purposes only and does not serve as a heat sink.



**Series 652 Optically Isolated AC Solid-State Relays**

The Series 652 is an AC output solid-state relay designed for power switching. It incorporates a sealed, optically coupled solid-state relay as a zero-voltage turn-on driver. The input circuit is TTL logic compatible. Output switching is accomplished by back-to-back SCRs with a built-in snubber circuit, which provides reliable switching of both resistive and reactive loads.

- Qualified to MIL-PRF-28750
- Zero-voltage turn-on, zero-current turn-off
- Logic compatible input
- Sealed aluminum case
- High transient immunity and low EMI

Part No.	OUTPUT (Load)				INPUT (Control)	MECHANICAL		
	Load Voltage	Load Current	ON-State Voltage Drop	Zero-Cross Window	Input Voltage	Operating Temperature	Mounting	Dimensions LxWxH
652-1*	250 Vrms	25 A	1.5 Vrms	±15 V	4–32 Vdc	–55°C to +110°C	Terminal	2.410 x 1.57 x 1.845 in. 61.5 x 39.88 x 46.86 mm
652-2*	250 Vrms	25 A	1.5 Vrms	±40 V	4–32 Vdc	–55°C to +110°C	Terminal	2.410 x 1.57 x 1.845 in. 61.5 x 39.88 x 46.86 mm

\*A “W” suffix denoting Teledyne’s S<sup>2</sup>R reliability screening level or “Y” suffix denoting MIL-PRF-28750 level must be added to the part number. See Appendix, page 14.  
-1 = DSCC Drawing Number M28750/10-001; -2 = DSCC Drawing Number M28750/10-002.

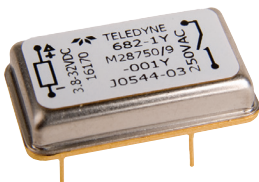

**Series 682 Optically Isolated AC Solid-State Relays**

The 682 is a state-of-the-art solid-state relay designed for use in AC power switching applications. Back-to-back SCRs are configured for zero-voltage turn-on and can handle current surges up to 8A. The patented circuit design assures the lowest possible EMI by virtually eliminating commutation spikes while maintaining excellent noise immunity.

- Qualified to MIL-PRF-28750
- Zero-voltage turn-on SCR output
- Logic compatible input
- Extremely low EMI
- Low-profile metal DIP package

Part No.	OUTPUT (Load)				INPUT (Control)	MECHANICAL		
	Load Voltage	Load Current	ON-State Voltage Drop	Isolation Type	Input Voltage	Operating Temperature	Mounting	Dimensions LxWxH
682-1*	250 Vrms	2 Arms	1.5 Vrms	Optically Isolated	3.8–32 Vdc	–55°C to +110°C	Through-hole	.890 x 5.30 x .190 in. 22.6 x 13.5 x 4.83 mm

\*A “W” suffix denoting Teledyne’s S<sup>2</sup>R reliability screening level or “Y” suffix denoting MIL-PRF-28750 level must be added to the part number. See Appendix, page 14.

## AC RELAYS

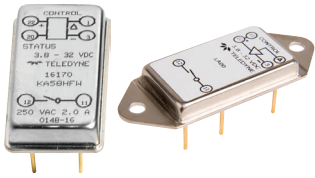

### Series KA/LA Optically Isolated AC Solid-State Relays

Series KA/LA solid-state relays are designed for use in AC power switching applications where safety and reliability are primary concerns. They are ideal for resistive and reactive loads with power factors as low as 0.2. Inverse parallel SCRs are configured for zero-voltage turn on. The relays are available with thermal protection and thermal trip status.

- Optical isolation
- Fully floating output
- Buffered control
- Integrated snubber circuit
- Low-profile hermetic package

Part No.	OUTPUT (Load)				INPUT (Control)		MECHANICAL			OPTION
	Load Voltage	Load Current	ON-State Voltage Drop	Isolation Type	Bias Supply Voltage	CMOS Control	Operating Temperature	Mounting	Dimensions LxWxH	Thermal Protection and Thermal Trip Status
KA58HF*	250 Vrms	2 Arms	1.2 Vrms	Optically Isolated	3.8–32 Vdc	250 $\mu$ A	–55°C to +110°C	Through-hole	1.375 x 0.801 x 0.22 in. 34.92 x 20.34 x 5.59 mm	✓
LA00HL*	250 Vrms	2 Arms (7.5 Arms with heat sink)	1.2 Vrms	Optically Isolated	3.8–32 Vdc	250 $\mu$ A	–55°C to +110°C	Through-hole	2.105 x 0.801 x 0.22 in. 53.47 x 20.34 x 5.59 mm	
LA58HL*	250 Vrms	2 Arms (7.5 Arms with heat sink)	1.2 Vrms	Optically Isolated	3.8–32 Vdc	250 $\mu$ A	–55°C to +110°C	Through-hole	2.105 x 0.801 x 0.22 in. 53.47 x 20.34 x 5.59 mm	✓

\*A "W" suffix denoting Teledyne's S<sup>2</sup>R reliability screening level or "Y" suffix denoting MIL-PRF-28750 level must be added to the part number. See Appendix, page 14.

## BIDIRECTIONAL RELAYS

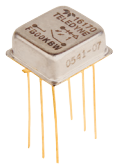

### Series FB Low-Leakage, High-Voltage Bidirectional and DC Solid-State Relays

The Series FB relay is an advanced solid-state bidirectional relay designed specifically for high-speed switching in ATE systems. These devices provide high reliability, low life-cycle cost and exceptional switch performance. The FB has very fast turn-on times of under 1 msec. Optical coupling minimizes EMI generation.

- High voltage output
- Extremely low leakage current (200 nA)
- Bidirectional power FET output
- Fast switching speed
- Low-profile metal 6-pin mini-DIP

Part No.	OUTPUT (Load)						Isolation Type	INPUT (Control)	MECHANICAL		
	Load Voltage		Load Current		ON Resistance			Input Current	Operating Temperature	Mounting	Dimensions LxWxH
	DC	AC	DC	AC	DC	AC					
FB00CD*	80 Vdc	±80 Vdc	2 Adc	±1 Adc	0.15 $\Omega$	0.6 $\Omega$	Optically Isolated	10–25 mAdc	–55°C to +120°C	Through-hole	0.458 x 0.418 x 0.190 in. 11.6 x 10.6 x 4.83 mm
FB00FC*	180 Vdc	±180 Vdc	1 Adc	±0.5 Adc	0.25 $\Omega$	1 $\Omega$	Optically Isolated	10–25 mAdc	–55°C to +120°C	Through-hole	0.458 x 0.418 x 0.190 in. 11.6 x 10.6 x 4.83 mm
FB00KB*	350 Vdc	±350 Vdc	0.5 Adc	±0.25 Adc	2 $\Omega$	8 $\Omega$	Optically Isolated	10–25 mAdc	–55°C to +120°C	Through-hole	0.458 x 0.418 x 0.190 in. 11.6 x 10.6 x 4.83 mm

\*A "W" suffix denoting Teledyne's S<sup>2</sup>R reliability screening level or "Y" suffix denoting MIL-PRF-28750 level must be added to the part number. See Appendix, page 14.

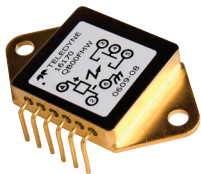

### Series QB00FM Bidirectional and DC Output Bidirectional Solid-State Relays

The QB00FM relay is an advanced solid-state bidirectional relay designed for high-speed power switching applications. It provides high reliability, low life-cycle cost and exceptional switch performance. The QB00FM is capable of switching AC or DC power and is suitable for heat sink or circuit card mounting. Pin 6 is connected to the case for additional safety shielding.

- High voltage output
- Low ON resistance
- Power FET output
- Fast switching speed
- High surge current capability

Part No.	OUTPUT (Load)						Isolation Type	INPUT (Control)	MECHANICAL		
	Load Voltage		Load Current		ON Resistance			Input Voltage	Operating Temperature	Mounting	Dimensions LxWxH
	DC	AC	DC	AC	DC	AC					
QB00FM*	150 Vdc	±150 Vdc	7.5 Adc	±4.3 Adc	0.035 $\Omega$	0.10 $\Omega$	Optically Isolated	4.5–16 Vdc	–55°C to +105°C	Through-hole	1.870 x 1.010 x 0.275 in. 47.5 x 25.65 x 6.99 mm

\*A "W" suffix denoting Teledyne's S<sup>2</sup>R reliability screening level or "Y" suffix denoting MIL-PRF-28750 level must be added to the part number. See Appendix, page 14.



**Series C60 Optically Isolated DC and Bidirectional Solid-State Relays**

Series C60 solid-state relays use an advanced design capable of switching very heavy loads in a physically small 6-pin mini-DIP package. These relays have a power FET output that ensures low ON resistance, no offset voltage and low leakage current. In addition to switching DC loads, the versatile C60 can switch AC and bidirectional loads as well. **Moisture Sensitivity Level (MSL) 1**

- Low on-state resistance
- Up to 2.5A output
- Optically isolated
- Three-terminal output
- Through-hole or surface-mount configuration

<b>Isolation Type</b>
Optically Isolated
<b>Operating Temperature</b>
-40°C to +85°C
<b>Mounting</b>
C = Through-hole SC = Surface
<b>Dimensions LxWxH</b>
Through-hole 0.39 x 0.25 x 0.15 in. 9.91 x 6.35 x 3.81 mm
Surface 0.39 x 0.25 x 0.175 in. 9.91 x 6.35 x 4.45 mm

Part No.	OUTPUT (Load)						INPUT (Control)
	Load Voltage		Load Current		ON Resistance		Input Current
	DC	AC	DC	AC	DC	AC	
C60-10	60 Vdc	±60 Vdc	2.5 Adc	±1.25 Adc	0.07 Ω	0.28 Ω	10–50 mA
SC60-10	60 Vdc	±60 Vdc	2.5 Adc	±1.25 Adc	0.07 Ω	0.28 Ω	10–50 mA
C60-20	100 Vdc	±100 Vdc	1.5 Adc	±0.75 Adc	0.2 Ω	0.7 Ω	10–50 mA
SC60-20	100 Vdc	±100 Vdc	1.5 Adc	±0.75 Adc	0.2 Ω	0.7 Ω	10–50 mA
C60-30	200 Vdc	±200 Vdc	1 Adc	±0.50 Adc	0.45 Ω	1.8 Ω	10–50 mA
SC60-30	200 Vdc	±200 Vdc	1 Adc	±0.50 Adc	0.45 Ω	1.8 Ω	10–50 mA
C60-40	400 Vdc	±400 Vdc	0.5 Adc	±0.25 Adc	1 Ω	4 Ω	10–50 mA
SC60-40	400 Vdc	±400 Vdc	0.5 Adc	±0.25 Adc	1 Ω	4 Ω	10–50 mA

## APPENDIX: Quality Conformance Inspection

**All tests are 100% unless otherwise noted.**

Inspection	S <sup>2</sup> R Level "W"	S <sup>2</sup> R Level "T"	MIL-PRF-28750 Level "Y"
Destructive Wirebond Pull Test (Sample test) MIL-STD-883 Method 2011	✓	✓	✓
Internal Visual MIL-STD-883 Method 2017	✓	✓	✓
Constant Acceleration MIL-STD-883 Method 2001, 5000 Gs, Y1 axis			✓
Temperature Cycling MIL-STD-883 Method 1010, 10 cycles	✓ Specified temp range	✓ Specified temp range	✓ -55° to +125°C
Load Conditioning 3 hours at rated input and load 90% duty cycle, 1 to 30 operations per second (latching fault indication for drop out)	✓	✓	✓
Pre Burn-In (optional)			✓
Burn-in Test MIL-STD-883 Method 1015, 160 hours at specified temperature and rated load (latching fault indication on failure)		✓ (48 hours of same testing for plastic- packaged relays)	✓
Dielectric Withstanding Voltage MIL-STD-202 Method 301	✓	✓	✓
Insulation Resistance MIL-STD-883 Method 1003	✓	✓	✓
Electrical Characteristics at -55°C		✓	✓
Electrical Characteristics at +25°C	✓	✓	✓
Electrical Characteristics at +125°C (or as specified)		✓	✓
Seal MIL-STD-202 Method 112 (Gross) MIL-STD-883 Method 1014 (Fine)	✓ (N/A for plastic- packaged relays)	✓ (N/A for plastic- packaged relays)	✓
Visual/Mechanical (Sample test)	✓	✓	✓
Solderability (2 Samples) MIL-STD-202 Method 208		✓	✓

## APPENDIX: Glossary

<b>DSCC</b>	Defense Supply Center Columbus. Organization that provides information and recommendations to contractors on commonality and selection of parts, and to manufacturers for qualification of the parts.
<b>DSCC Drawing</b>	This is a drawing created by DSCC for parts manufactured to a military specification but are not yet qualified to that specification. These parts may be used in military programs until a slash sheet is created and parts are qualified to the military specification.
<b>MIL-PRF-28750</b>	General specification for solid-state relays. This military specification covers the design, construction, manufacture, performance, test, and screening of military solid-state relays. Relays qualified to this specification are JAN branded and are suitable for all military programs.
<b>Relay, Solid-State (SSR)</b>	A relay with isolated input and output whose functions are achieved by means of electronic components without moving parts.
<b>Relay, Zero-Voltage Turn-On</b>	A relay with isolated input and output in which added control circuitry delays the output turn-on until the zero-voltage transition of the AC sine wave.
<b>Short-Circuit Protection</b>	<p>A feature incorporated into the output circuit of a solid-state relay to protect the relay and circuitry against a shorted load. The relay output will turn-off should a short occur. The output can be reset from the control.</p> <p>The graph plots Current (A) on the y-axis (0 to 16) against Trip Time (Seconds) on the x-axis (0.01 to 100, logarithmic scale). Three curves represent temperatures: -55C (top), +25C (middle), and +85C (bottom). The -55C curve shows a sharp drop in current at approximately 0.1 seconds. The +25C and +85C curves show a more gradual decrease. Two horizontal lines are drawn at approximately 3.0A and 2.0A, labeled '3.0' and '2.0' respectively. The region above the 3.0A line is labeled 'GUARANTEED TRIP REGION', and the region below the 2.0A line is labeled 'GUARANTEED NO TRIP REGION'.</p>
<b>Status, Switch</b>	Indicates the state of the output. It operates independently of the control/bias and will return a status as long as load voltage and load circuit continuity exists. It is generated from the load supply and creates an offstate leakage from 600 $\mu$ A to 2 mA.
<b>Status, Flow</b>	Indicates whether there is load current flowing. It operates only when the output is conducting and has a threshold of 10% to 20% of the maximum rated output current. It does not create an OFF-state leakage, but only operates when the output circuit is conducting.
<b>Status, Trip</b>	This type of status is only applicable for short-circuit protected relays. It provides an indication when the short-circuit protection has been activated and the output has tripped off. It does not indicate the normal state of the output.
<b>Status, Control</b>	This type of status provides an indication of control circuit continuity. It is analogous to the second set of contacts of a double-pole electromechanical relay. It does provide much higher output drive capability than the other types of status outputs.

**Description**

The InP1012 Series is a highly compact, reflective SPDT Active RF switch, manufactured using Teledyne's high speed, low-loss InP HEMT process. The switch die is packaged in a low-loss, surface mount package, with a small form factor: 3mm(L) x 3mm(W) x 1mm(H). It supports a wide frequency range from DC to 60GHz, and delivers low insertion loss, fast switching time, and good isolation-making this switch ideal for test and measurement, microwave communications, and radar applications. The unique construction features and manufacturing techniques provide excellent robustness to environmental extremes and overall high reliability

**Features**

- High digital bandwidth, greater than 40Gbps
- Very high linearity
- Low insertion loss
- Very fast switching time of less than 100ns
- Radiation tolerant up to 100 krad

Frequency Range
DC -60GHz
Bit Rate
40+ Gbps
Operate Time
60-100ns
Enclosure
Low-Loss Surface Mount Package
Dimensions
3mm (L) x 3mm (W) x 1mm (H)
Temperature
Storage: -65°C to +125°C Operating: -65°C to +125°C

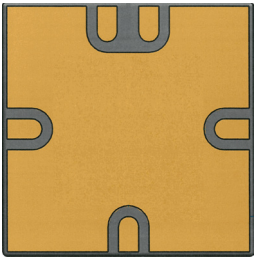
Part No.	Typical RF Performance			
	Frequency	Insertion Loss (dB)	Isolation (dB)	Return Loss (dB)
 <p style="text-align: center;"><b>InP1012</b></p> <p style="text-align: center;">** Also available in Die form **</p>	DC (20mV-200mV)	2.0	---	---
	10KHz	0.9	67	---
	100MHz	1.2	60	23
	6GHz	1.6	37	21
	14GHz	2.0	30	21
	20GHz	2.3	27	23
	30GHz	2.6	24	26
	40GHz	2.9	21	25
	50GHz	3.3	19	25
	60GHz	3.7	17	16

**TYPICAL SIGNAL INTEGRITY CHARACTERISTICS @ 40Gbps**

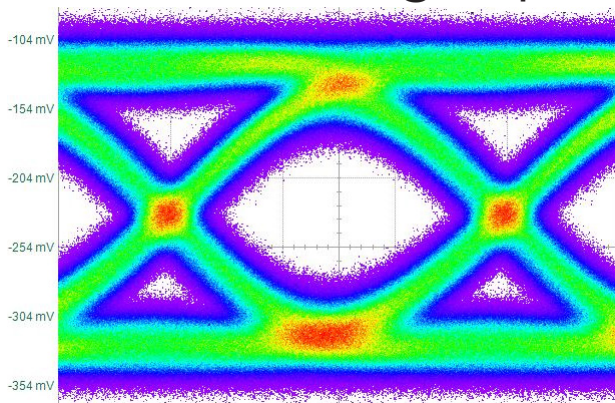

**PATTERN GENERATOR SETTINGS**

- 2<sup>31</sup>-1 PRBS signal
- 40Gbps data rate
- Data amplitude of 500mVpp

**OUTLINE DIMENSIONS**

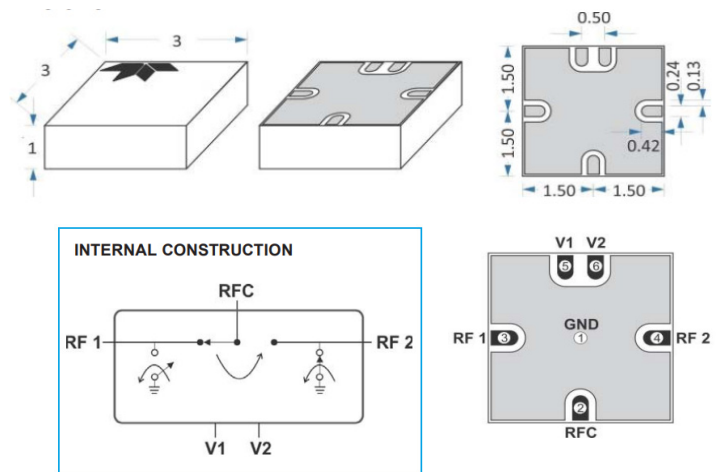

# Series RF121 / GRF121

SPDT Magnetic-Latching  
Up to DC-18GHz RF Relay  
Signal Integrity up to 40Gbps





**TELEDYNE  
RELAYS**  
Everywhereyoulook™

## Series GRF121 Electromechanical Relays

The ultraminiature GRF121 relay is designed to provide a practical surface-mount switching solution with RF performance and repeatability to 18GHz. The GRF121 improves on Teledyne Relays' heritage of miniature RF relays by incorporating a precision transmission line structure in the internal construction of the contact system. GRF121 relays feature a unique ground shield to facilitate surface mounting and to extend the frequency range when compared to through-hole solutions.

- Broader bandwidth (DC - 18GHz)
- Excellent Signal integrity up to 40Gbps
- Hermetically Sealed
- High Resistance to ESD
- Metal Enclosure for EMI shielding
- High Repeatability
- 3 Million Cycle Life

Relay Type
SPDT Magnetic-Latching
Frequency Range
RF121 = DC - 12GHz GRF121 = DC - 18GHz
Bit Rate
RF121 = 20Gbps GRF121 = 40Gbps
Mounting
RF = Thru-hole GRF = Surface-Mount (Stub)
Available Coil Voltages
5V: Coil Resistance ( $\Omega$ ) = 61 12V: Coil Resistance ( $\Omega$ ) = 500
Temperature
Storage: $-65^{\circ}\text{C}$ to $+125^{\circ}\text{C}$ Operating: $-55^{\circ}\text{C}$ to $+85^{\circ}\text{C}$

Part No.	Typical RF Performance			
	Frequency (GHz)	VSWR (max)	Isolation (dB)	Insertion Loss (dB) (max)
 <b>RF121</b>	DC - 4	1.3 : 1	55	0.25
	4 - 8	1.50 : 1	50	0.45
	8 - 12	2.0 : 1	40	1.35
 <b>GRF121</b>	DC - 4	1.1 : 1	65	0.2
	4 - 8	1.20 : 1	50	0.2
	8 - 12	1.35 : 1	40	0.5
	12 - 16	2.0 : 1	30	0.95
	16 - 18	2.3 : 1	30	1.1

**RF121 : 20Gbps**

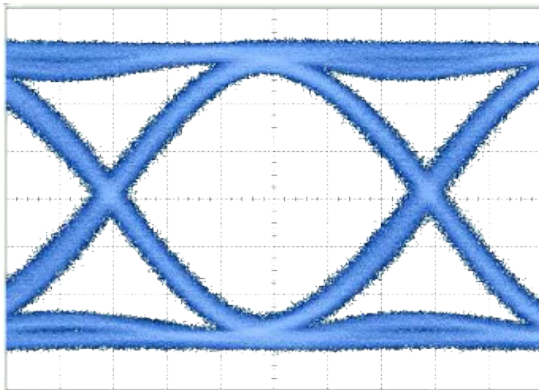

Bit Rate	Eye Height	Eye Width	Jitter <sub>p,p</sub>
20Gbps	360 mV	40.3 ps	6.93 ps

### PATTERN GENERATOR SETTINGS

- 20Gbps Random Pulse Pattern Generator
- $2^{31} - 1$  PRBS signal
- PRBS output of 500 mV<sub>p,p</sub> (nominal)
- RF PCB effect (negligible) not removed from measurement
- Data shown is typical of both contacts

**GRF121 : 40Gbps**

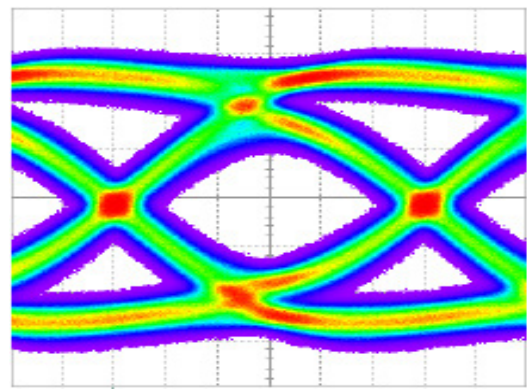

Bit Rate	Eye Height	Eye Width	Jitter <sub>p,p</sub>
40Gbps	95 mV	13.34 ps	8.73 ps

### PATTERN GENERATOR SETTINGS

- 40Gbps Random Pulse Pattern Generator
- $2^{31} - 1$  PRBS signal
- PRBS output of 500 mV<sub>p,p</sub> (nominal)
- RF PCB effect (negligible) not removed from measurement
- Data shown is typical of both poles

**Description**

The Mini Matrix Series is an ideal solution that incorporate Teledyne Coax Switches' for off the self, easy to use application. The Mini Matrix Series is designed to allow the remote operation of SPDT, Transfer, or SP3T to SP8T Multi-Throw switches. Remote operation is accomplished via TCP/IP commands to the Matrix's Ethernet interface. Switch control is also accessible via the USB virtual serial port, using the provided command set. Through these interfaces the Coax Switch can be switched to the desired position and its position can be read for verification. The default switch position at power up can be set by the user.

**Options**

- USB only or USB & Ethernet Control
- Terminated or Non-Terminated
- Failsafe or Latching
- Various Connectors
- Multiple Frequency Ranges

<b>Number of Switches</b>
1 to 2 SPDT, Transfer, or SP3T-SP8T
<b>Switching Type</b>
Electromechanical
<b>Temperature</b>
Operating: -40°C to +65°C

Additional Information	
<b>Available Connectors</b>	SMA, 2.92 mm, Type N, TNC
<b>Line Power</b>	Universal 90-260 VAC, 47-63Hz
<b>Enclosure A Size (WxHxD) (Non-Terminated SPMT)</b>	5.08" Wide, 2.17 High, 7.75" Depth
<b>Enclosure B Size (WxHxD) (Terminated SPMT)</b>	8.00" Wide, 3.00" High, 8.00" Depth
<b>Typical Cycle Life</b>	5,000,000 cycles

Connector Types	Frequency Range
<b>2.92 mm</b>	DC - 40GHz
<b>SMA</b>	DC - 26.5GHz
<b>Type N</b>	DC - 12GHz
<b>TNC</b>	DC - 12GHz

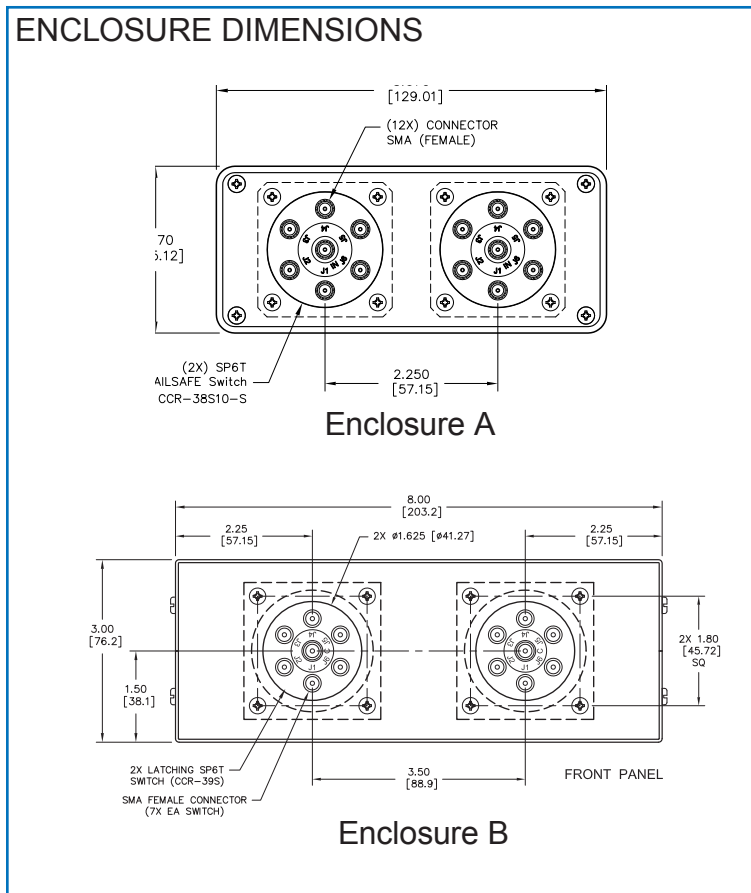



**Teledyne has over 50 years of experience in developing a wide spectrum of custom solutions.**

**Experienced in Custom Hybrid Solutions**

Teledyne Relays is a leading manufacturer with the capability of providing build-to-print solutions on hybrid microcircuits devices. Our current products portfolio includes solid state power controllers, DC/DC converters, high current drivers, digital-analog converters, activator control hybrids, deflection amplifiers, base drivers, custom designed multi-layers thick-film/thin film substrates and many more...

With over 50 years of heritage in serving the space, aerospace, and defense markets, Teledyne continues to uphold the same standards and commitment to excellence. Our optimized solutions are supported by teams of engineers and manufacturing personnel with wide ranging experiences in developing products deployed in highly demanding applications, such as electrical power systems, radar receivers, and stores management solutions, for ground or aerial defense platforms.

Teledyne is accredited by Defense Logistics Agency (DLA) in accordance with MIL-PRF-38534, Class H and Class G Qualified Manufacturers List (QML). Since 2014 Teledyne has successfully launched over twenty hybrids into production for our customers. We welcome opportunities to partner with our customers to provide customized solutions to your hybrid needs. Our typical custom solution development cycle is as follows:



## Teledyne Relays offers electromechanical relays for various markets?

### RF RELAYS

- Signal Integrity up to 40Gbps
- DC - 16GHz
- Surface-Mount
- DPDT, SPDT, 4PST and Loopback Relays

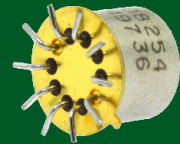

### MILITARY GRADE RELAYS

- Built and tested to meet MIL-PRF-39016
- Built and tested to meet MIL-PRF-28776
- Built-in Diodes, Transistor Driver and CMOS
- Low Power coils

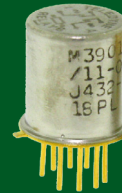
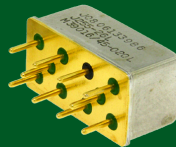

### TELEDYNE ESTABLISHED RELIABILITY RELAYS

- Fully defined product requirements and screening levels
- Spacer/Spreader pad options not allowed by military specifications
- Reduced lead time and cost vs Military Grade

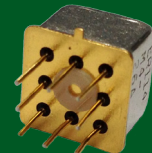
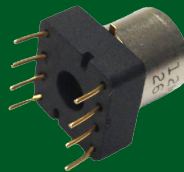

### HIGH PERFORMANCE RELAYS

- -65 °C to +200 °C
- Shock up to 4,000 g's
- Vibration up to 380 g's
- Non-Latching & Magnetic-Latching



### COMMERCIAL RELAYS

- Standard electrical tests at 25 °C
- "Low cost" switching solutions
- Surface-Mount
- Short lead times

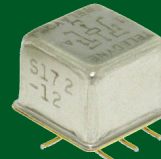

# Did you know...

Teledyne Coax Switches offers coaxial switches for ATE, Radar, Amplifier Switching, Etc.?

## SPDT SWITCHES

- DC - 40GHz, Internal 50  $\Omega$  Termination
- SMA, mini-SMB, TNC & N Connectors
- 5 Million Cycles
- High Power & Low PIM
- Failsafe & Latching



## TRANSFER SWITCHES

- DC - 18GHz
- SMA, TNC & N Connectors
- 5 Million Cycles
- High Power
- Failsafe & Latching



## MULTI-THROW SWITCHES

- DC - 40 GHz, Internal 50  $\Omega$  Termination
- SMA, mini-SMB, TNC & N Connectors
- SP3T - SP10T
- 5 Million Cycles
- Normally Open & Latching



## LOW PIM SWITCHES

- DC - 3 GHz
- SMA, N and 7/16 D Connectors
- SPDT, Transfer and Multi-Throw
- Failsafe & Latching



## SPECIALTY SWITCHES

- DC - 40GHz
- 3-State Attenuated Switch
- Radiation Shielding
- Switch Blocks
- Redundant Diode Configuration



## Teledyne Relays offers Commercial/Industrial Solid State Relays?

### SINGLE PHASE AC SOLID STATE RELAYS

- Up to 690Vac, 125A
- Input & Output Protection
- Chassis, DIN Rail and PCB Mount
- Zero-Cross & Random Switching
- Touch-Proof Covers



### DUAL-PHASE AC SOLID STATE RELAYS

- Up to 600Vac, 50A
- Output Protection
- Chassis and DIN Rail
- Zero-Cross & Random Switching
- Touch-Proof Covers



### 3 & 4 PHASE SOLID STATE RELAYS

- Up to 600Vac, 75A
- Output Protection
- Chassis and DIN Rail
- Zero-Cross & Random Switching
- DC & AC Control

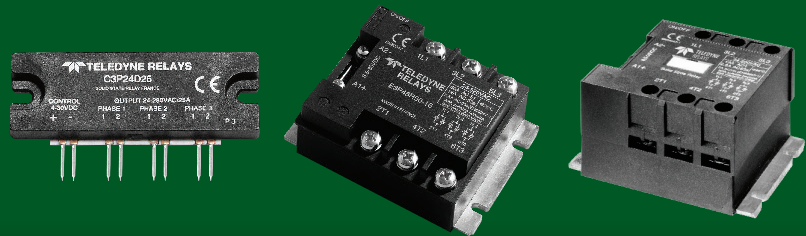

### DC SOLID STATE RELAYS

- Up to 1400Vdc, 100A
- Output Protection
- Chassis, DIN Rail and PCB Mount
- IGBT and MOSFET
- Touch-Proof Covers



### SOFT START MOTOR CONTROLLERS AND MOTOR REVERSERS

- Up to 26kW, 480Vac
- Star & Delta Configurations
- DIN Rail
- Output Protection
- Built-in Diagnostics and Self Test

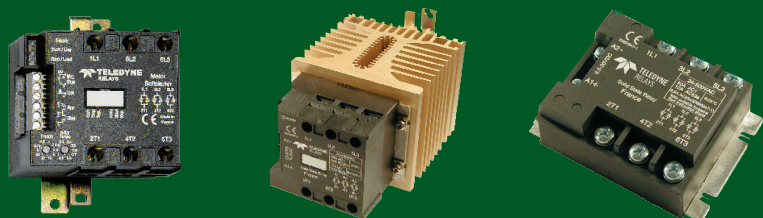

# Did you know...

## Teledyne Relays offers Military Solid State Relays?

### DC SOLID STATE RELAYS

- Meet MIL-PRF-28750
- Tested Per MIL-STD-704
- Silicon Carbide MOSFET
- Up to 250Vdc, 1A
- Chassis and PCB Mount
- Short-Circuit Protection
- Plastic and Hermetically Sealed



### BI-DIRECTIONAL/AC SOLID STATE RELAYS

- Meet MIL-PRF-28750
- Tested Per MIL-STD-704
- Up to 250Vac, 25A
- Chassis and PCB Mount
- Short-Circuit Protection
- Plastic and Hermetically Sealed

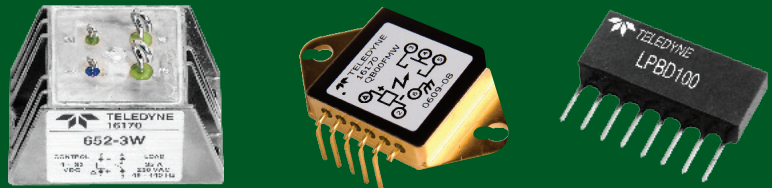

### COMMERCIAL, LOW POWER, I/O MODULES

- Up to 250Vac, 10A
- Short-Circuit Protection
- Chassis and PCB Mount
- Zero-Cross & Random Switching
- Low Off-State Leakage Current



### SILICON CARBIDE TECHNOLOGY

- Up to 270Vdc, 20 A
- Meet MIL-PRF-28750
- Tested Per MIL-STD-704
- Low ON resistance
- Low Profile Hermetic Package

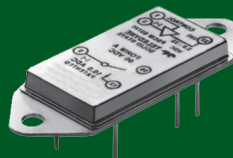

# Did you know...

**Teledyne Coax Switches offers coaxial switch matrices for ATE, Radar, Filter Switching, Airborne Surveillance Systems, Etc.?**

## MINI MATRICES

- Remote Control via USB and/or Ethernet
- GUI controllable
- Accepts ASCII code
- Available in 18, 26.5 and 40 GHz
- SPDT, Transfer and Multi-throw configurations

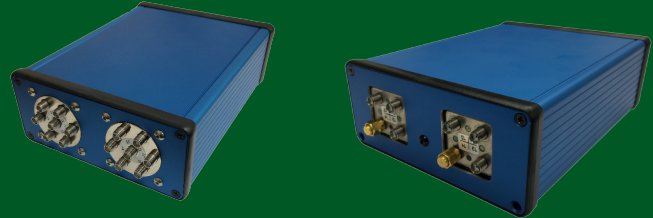

## MULTIPLEXOR/FANOUT SWITCH MATRICES

- Up to 1x1024 Switch Matrix
- SMA, mini-SMB, TNC & N Connectors
- Failsafe, Latching or Normally Open Configurations
- Switching Systems for 50 Ω & 75 Ω applications

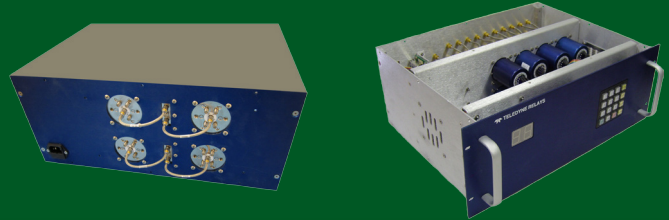

## MIMO/BLOCKING AND MIMO SINGLE CONNECTION SWITCH MATRICES

- Up to 1x1024 Switch Matrix
- SMA, mini-SMB, TNC & N Connectors
- RS-232, TTL, USB, GPIB, TTL, Ethernet Control
- 1 Million Cycles
- Failsafe & Latching

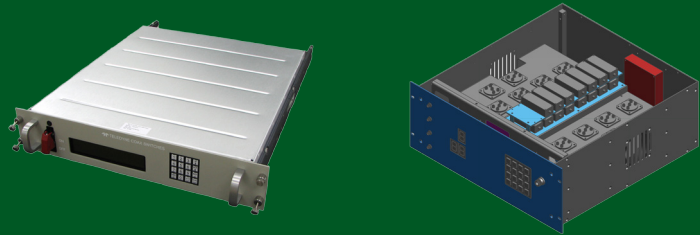

## CUSTOMIZED SWITCH MATRICES

- EMI/RFI
- Transient Suppression
- Ballistic Shock Fatigue
- Crash Load
- Altitude



# Did you know...

## Teledyne Relays offers Space Qualified Switches?

### SPACE MARKET SEGMENTS SERVED

- *Deep-Space Probes*
- *Manned Programs*
- *Communications Satellites*
- *Launch Vehicles*
- *Earth Observatory / Weather Satellites*
- *Commercial / Military Satellites*

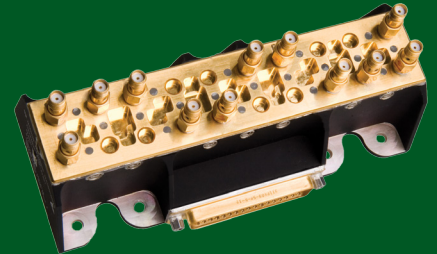
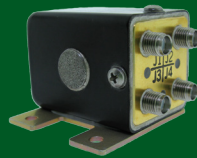

### CAPABILITIES

- *Logistic Infrastructure*
- *Chemical Analysis Lab*
- *Scanning Electro Microscope*
- *In-house Plating Shop*
- *Environment Test Lab*
- *Field Technical Support*

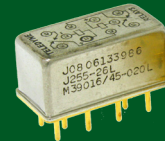

### ELECTROMECHANICAL RELAY SPECIFICATIONS

- *MIL-PRF-39016*
- *MIL-PRF-28776*
- *NASA/GSFC S-311-P-754*
- *NASA EEE-INST-002*
- *ESA/SCC 3601 & 3602*

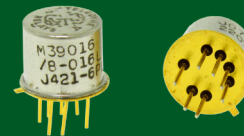

**HEADQUARTERS**  
12525 Daphne Ave.  
Hawthorne, CA 90250  
Phone: (323) 777-0077 or (800) 284-7007  
Fax: (323) 241-1287  
E-mail: [relays@teledyne.com](mailto:relays@teledyne.com)

**EUROPE**  
9-13 Napier Road  
Wardpark North  
Cumbernauld G68 OEF  
Scotland UK  
Phone: +44 (0) 1236 453 124  
Fax: +44 (0) 1236 780 651  
E-mail: [sales\\_europe@teledyne.com](mailto:sales_europe@teledyne.com)

[www.teledynerelays.com](http://www.teledynerelays.com)



**TELEDYNE**  
**RELAYS**  
Everywhereyoulook™